

[54] TAPE CUTTER

4,711,384 12/1987 Harris ..... 225/66

[76] Inventor: Rod W. Harris, 1011 Arlington Blvd., Suite 1020, Arlington, Va. 22209

[\*\*] Term: 14 Years

[21] Appl. No.: 171,936

[22] Filed: Mar. 23, 1988

[52] U.S. Cl. .... D19/69; D6/518

[58] Field of Search ..... D6/515, 518, 522-523; D19/69, 67; 225/56, 61, 65

FOREIGN PATENT DOCUMENTS

- 156426 10/1952 Australia .
- 243502 10/1960 Australia .
- 498366 1/1951 Belgium .
- 853525 10/1970 Canada .
- 1066913 10/1959 Fed. Rep. of Germany .
- 22465 6/1960 France .
- 533746 9/1955 Italy .
- 270395 1/1951 Switzerland .
- 915691 1/1963 United Kingdom .

Primary Examiner—Wallace R. Burke  
Assistant Examiner—Brian N. Vinson  
Attorney, Agent, or Firm—Banner, Birch, McKie & Beckett

[56] References Cited

U.S. PATENT DOCUMENTS

- D. 150,498 8/1948 Hazelton .
- D. 170,456 9/1953 Gershen .
- D. 182,862 5/1958 Wax et al. .... D19/69 X
- D. 273,644 5/1984 Colavito et al. .... D6/518
- D. 290,139 6/1987 Harris ..... D19/69
- D. 299,036 12/1988 Harris ..... D19/69
- 1,018,817 2/1912 Farrell ..... D6/518 X
- 2,262,260 11/1941 Smith .
- 2,284,807 6/1942 Donahoo et al. .
- 2,472,761 6/1949 Reed .
- 2,572,245 10/1951 Coldiron ..... 225/56
- 2,609,877 9/1952 Hanington ..... 225/65
- 2,626,666 1/1953 Coldiron .
- 2,676,658 4/1954 King .
- 2,677,425 5/1954 Broyles .
- 2,717,641 9/1955 Wiederspan .
- 2,727,572 12/1955 Carlo .
- 2,734,575 2/1956 Gilbreth et al. .
- 2,734,576 2/1956 Slezak .
- 3,378,184 4/1968 Mallory ..... 225/66
- 3,410,465 11/1968 Costello .
- 3,684,141 8/1972 Ball ..... 225/65
- 3,684,626 8/1972 Wood .
- 3,904,095 9/1975 Doyle ..... 225/65
- 3,970,230 7/1976 Horn ..... 225/65
- 4,405,068 9/1983 Blair ..... 225/65

[57] CLAIM

The ornamental design for a tape cutter, as shown and described.

DESCRIPTION

FIG. 1 is a front elevational view of a tape cutter showing my new design;  
 FIG. 2 is a rear elevational view thereof;  
 FIG. 3 is a side elevational view thereof, the opposite side being a mirror image of that shown;  
 FIG. 4 is a top plan view thereof;  
 FIG. 5 is a bottom plan view thereof;  
 FIG. 6 is a front elevational view of an alternate embodiment thereof;  
 FIG. 7 is a rear elevational view of the embodiment of FIG. 6;  
 FIG. 8 is a side elevational view of the embodiment of FIG. 6, the opposite side being a mirror image of that shown;  
 FIG. 9 is a top plan view of the embodiment of FIG. 6;  
 FIG. 10 is a bottom plan view of the embodiment of FIG. 6; and  
 FIG. 11 is a perspective view of the embodiment of FIG. 6.

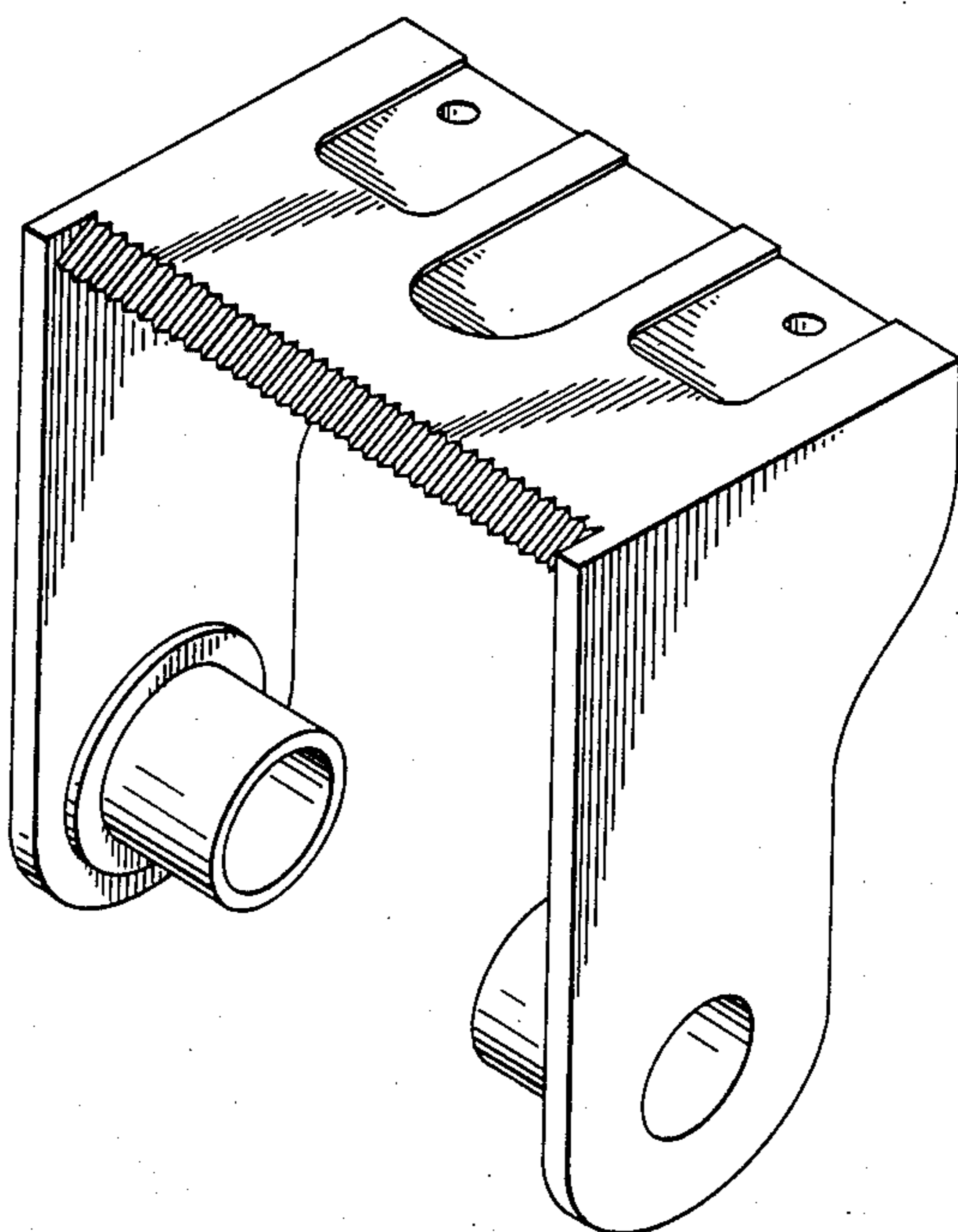

*FIG. 1*

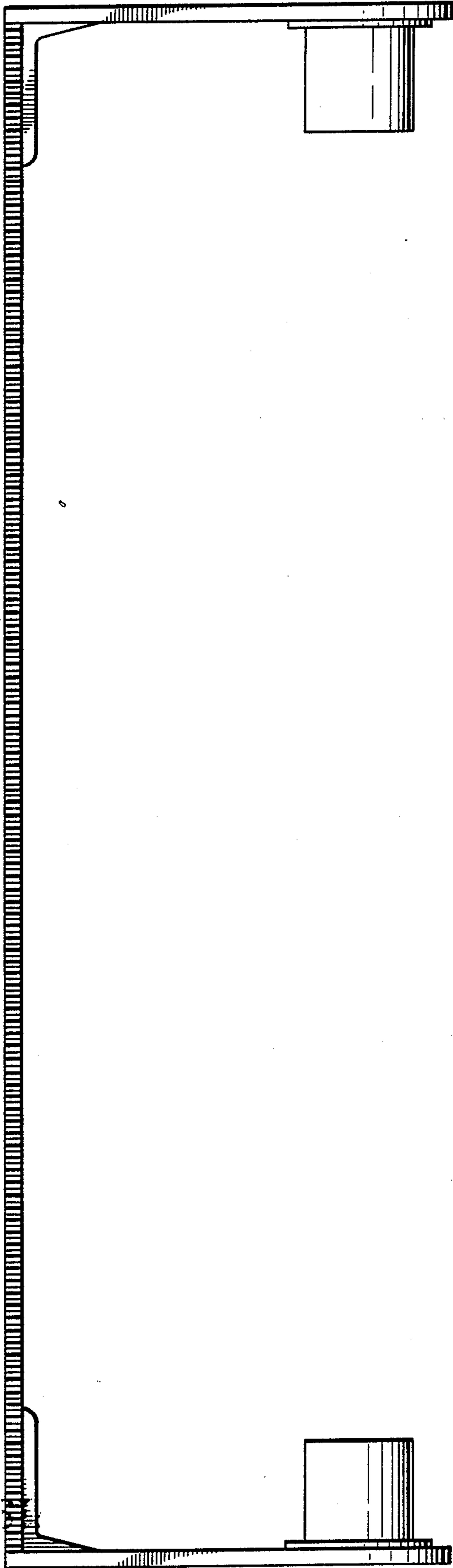

*FIG. 2*

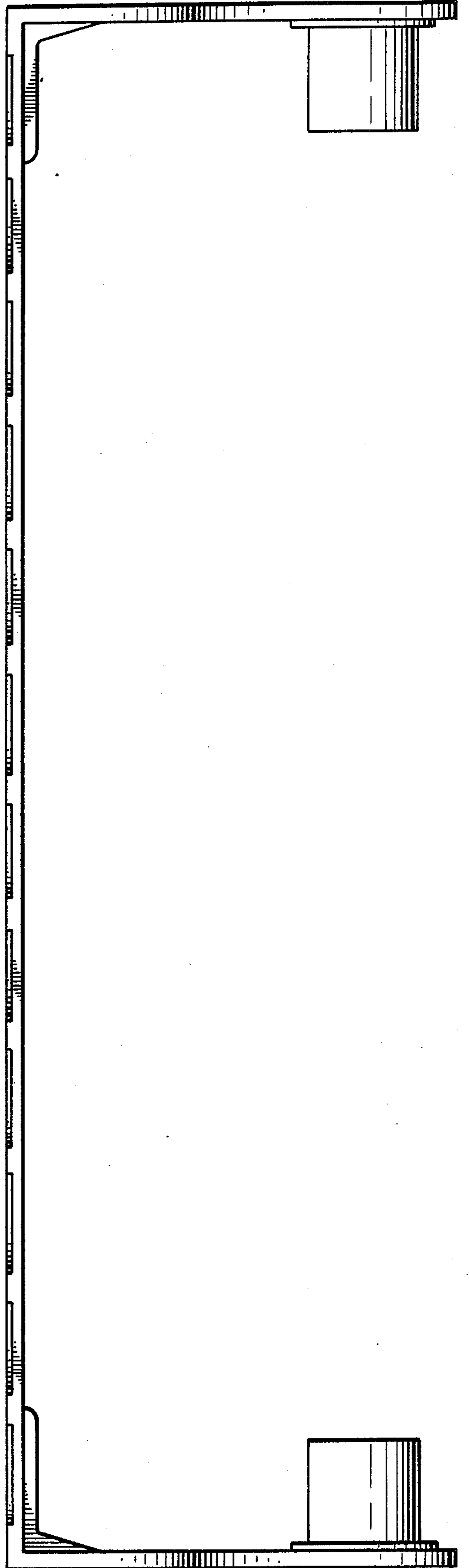

*FIG. 3*

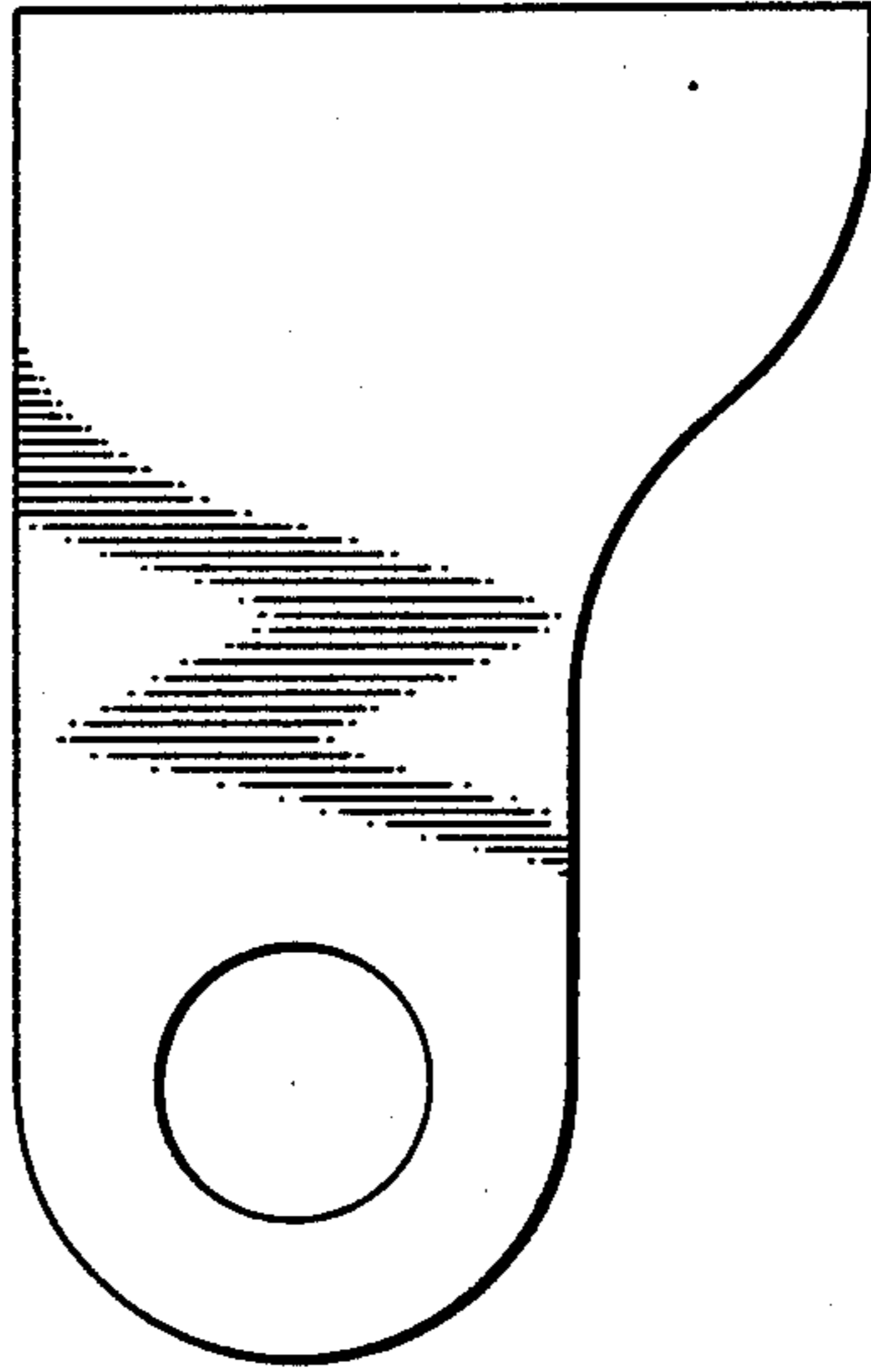

FIG. 5

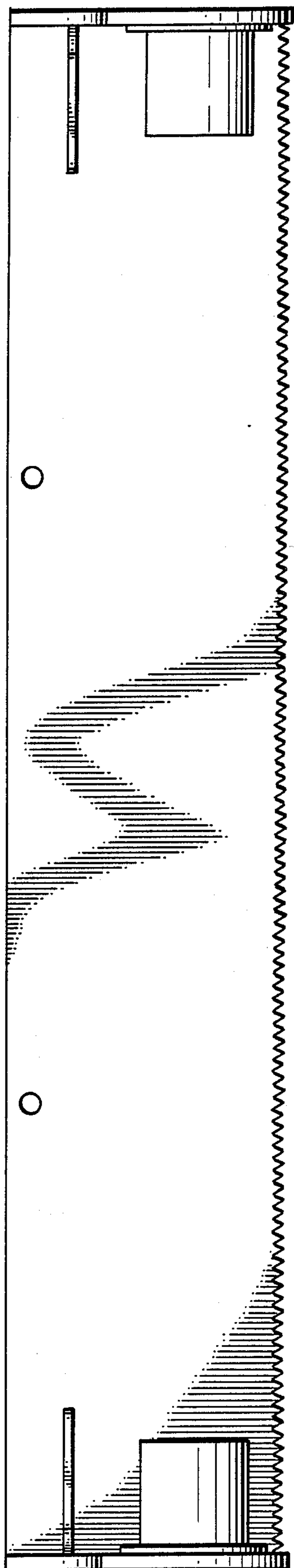
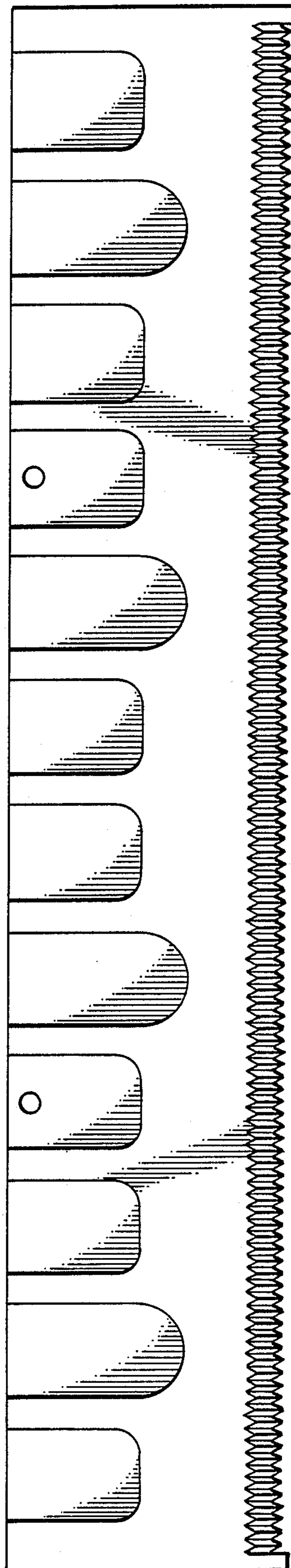
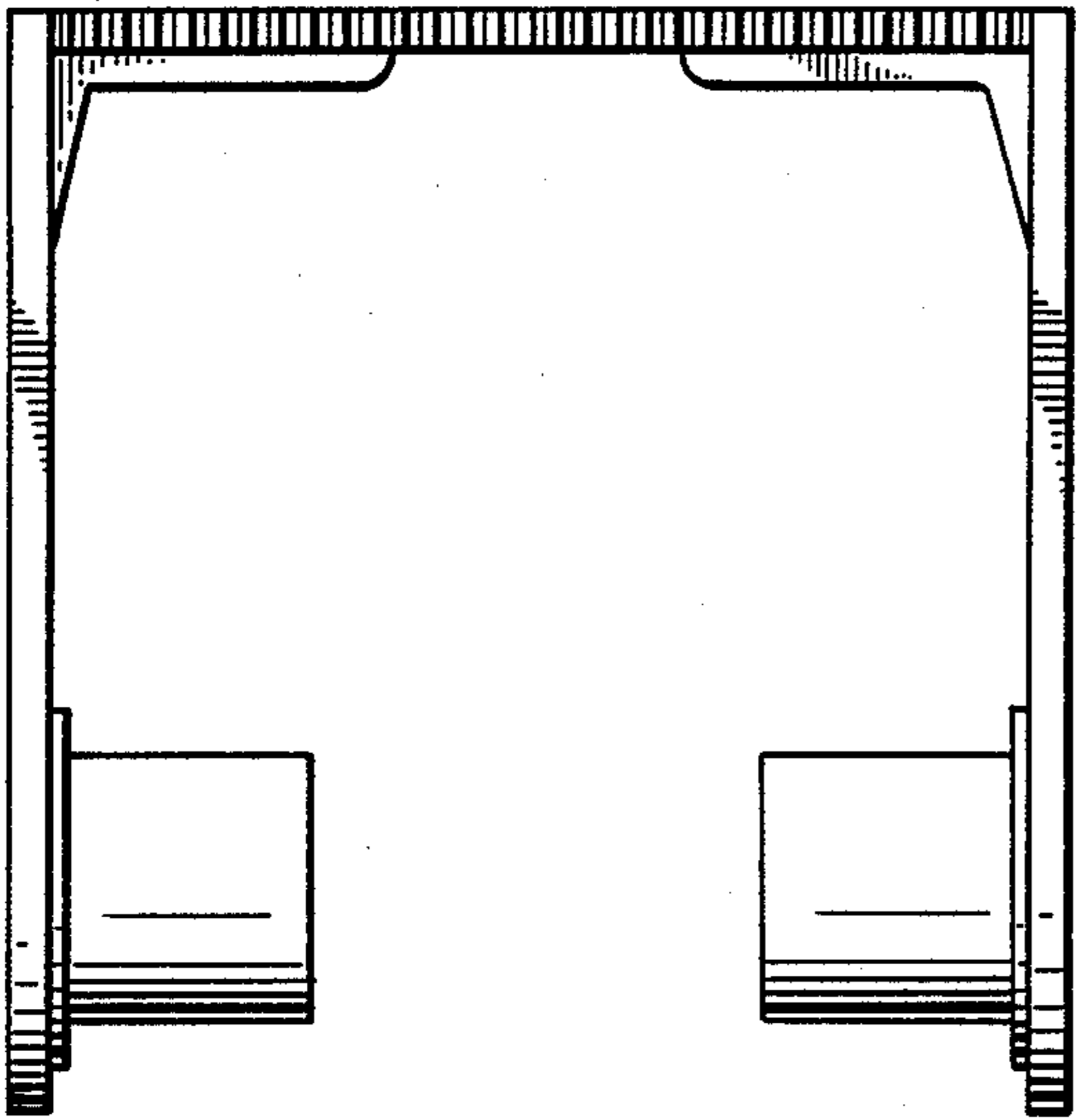

FIG. 4



*FIG. 6*



*FIG. 7*

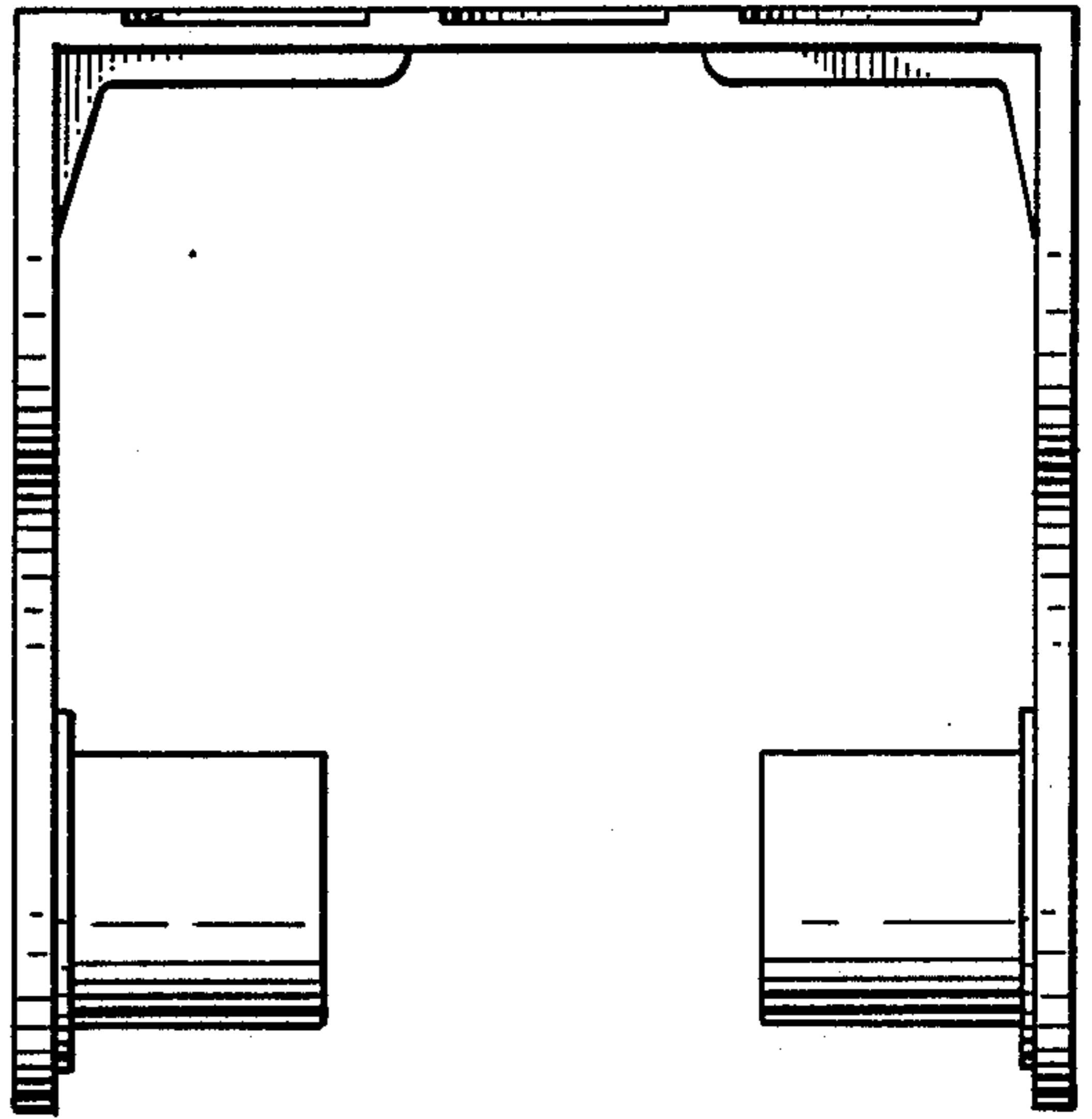

*FIG. 8*

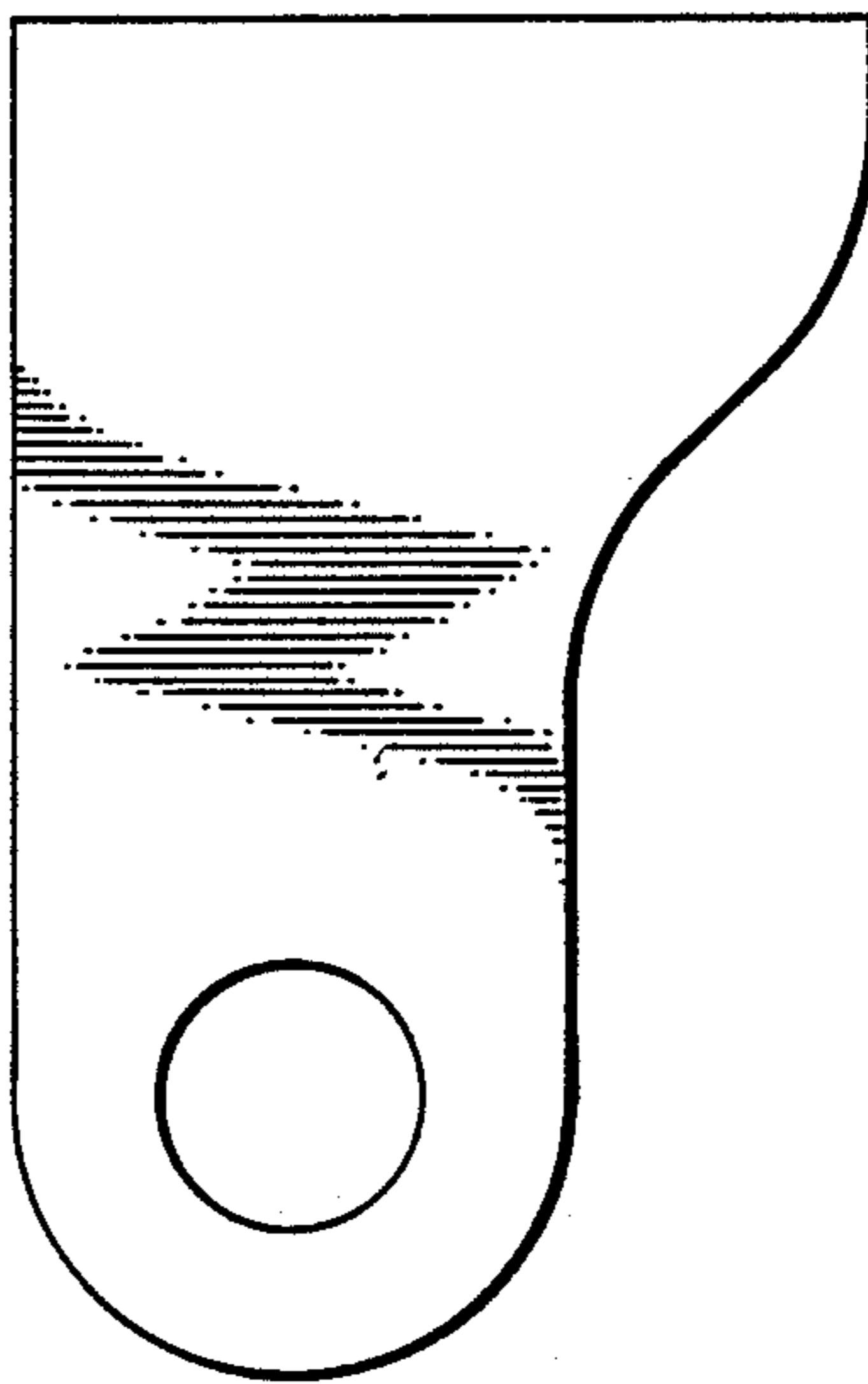

*FIG. 9*

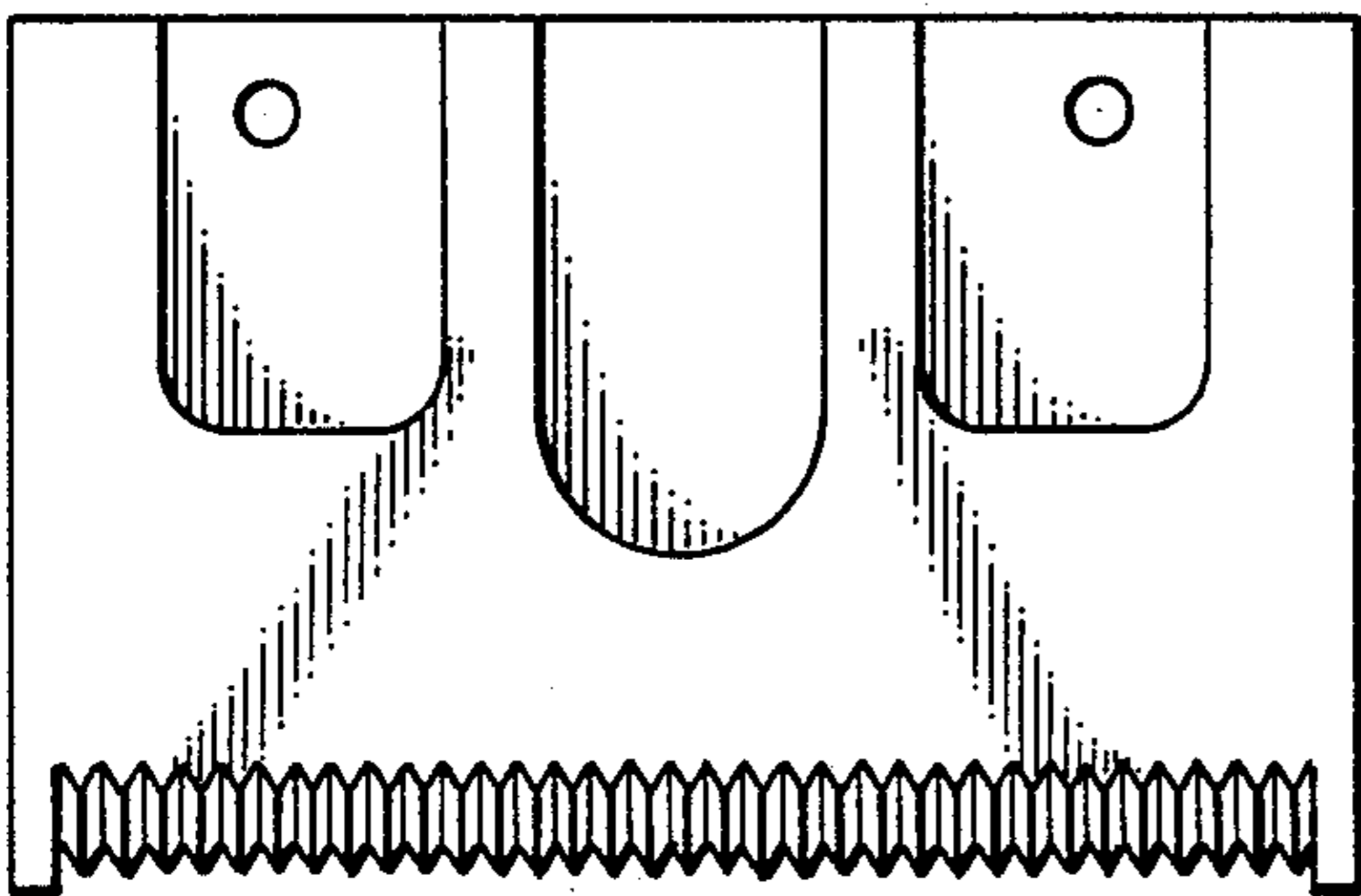

*FIG. 10*

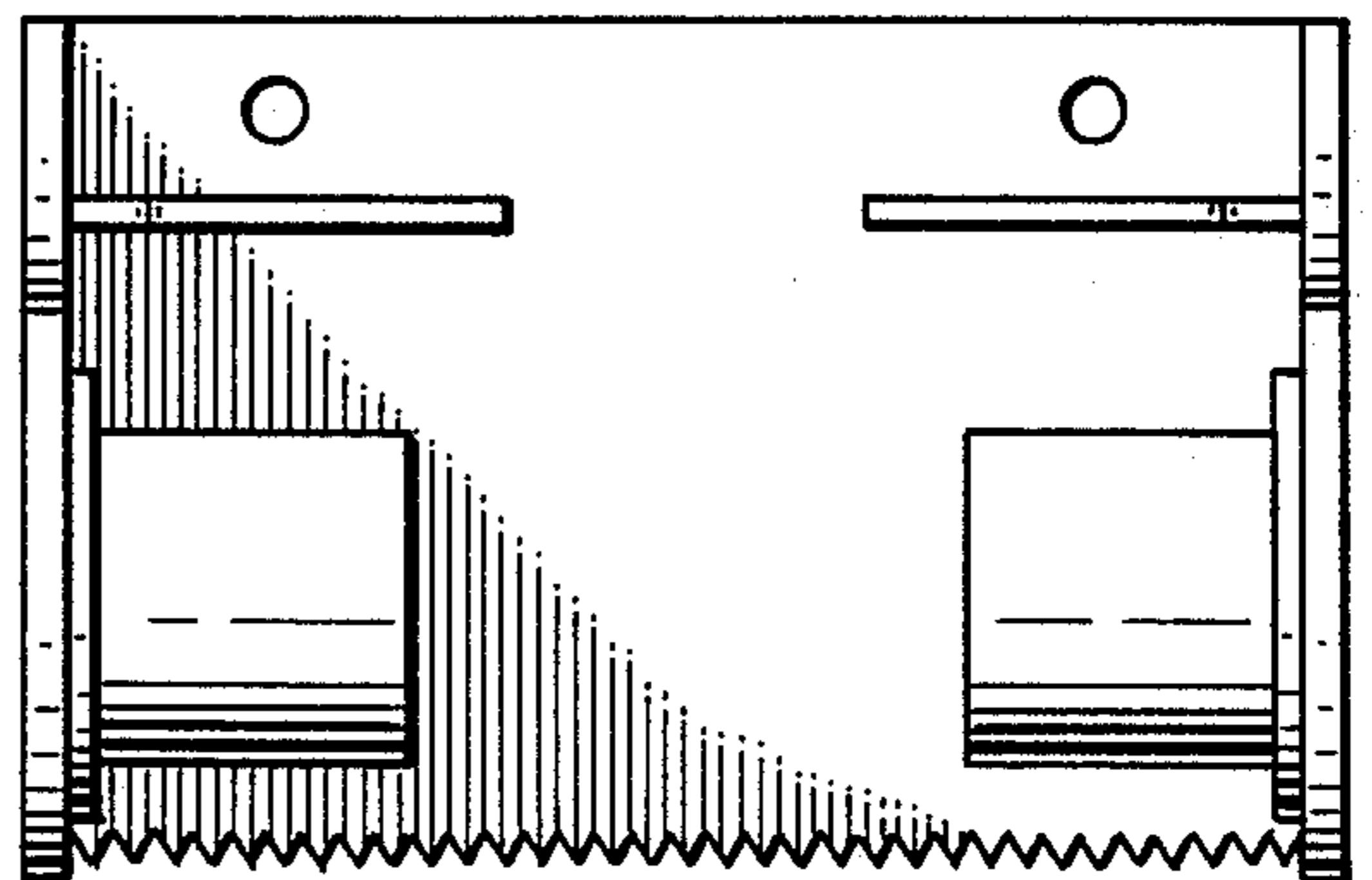



*FIG. 11*

