

[54] HOLDER FOR TELEPHONE INSTRUMENT OR SIMILAR ARTICLE

[76] Inventor: Robert A. Rioux, Jr., 6175 Crestview Rd., North Syracuse, N.Y. 13212

[\*\*] Term: 14 Years

[21] Appl. No.: 302,217

[22] Filed: Jan. 26, 1989

[52] U.S. Cl. .... D14/251

[58] Field of Search ..... D14/251, 253; 379/454, 379/455, 446

[56] References Cited

U.S. PATENT DOCUMENTS

D. 231,620	5/1974	Van Dyke	.....	D14/253
D. 286,636	11/1986	Cooke	.....	D14/253
2,243,554	5/1941	Epstein	.....	D14/253 X
2,987,585	6/1961	Abysalh	.....	379/455
3,021,396	2/1962	Nagel	.....	248/301
4,406,928	9/1983	Mackensie	.....	379/454
4,797,916	1/1989	Kojima	.....	379/454
4,819,266	4/1989	Awakowicz et al.	.....	379/454

FOREIGN PATENT DOCUMENTS

2100350 7/1971 Fed. Rep. of Germany ..... 379/455

Primary Examiner—Horace B. Fay, Jr.  
Attorney, Agent, or Firm—Wall and Roehrig

[57] CLAIM

The ornamental design for a holder for telephone instrument or similar article, as shown and described.

DESCRIPTION

FIG. 1 is a right side, top and front perspective view of a holder for telephone instrument or similar article showing my new design with a telephone instrument indicated therewithin in broken lines, and with the holder mounted over a pair of horizontal rails also shown in broken lines;

FIG. 2 is a front elevational view of the holder;

FIG. 3 is a left side elevational view thereof;

FIG. 4 is a rear elevational view thereof;

FIG. 5 is a right side elevational view thereof; and

FIGS. 6 and 7 are respectively top and bottom plan views thereof.

The broken line showing of a telephone instrument and truncated electric cord in FIG. 1 is for illustrative purposes only and forms no part of the claimed design.

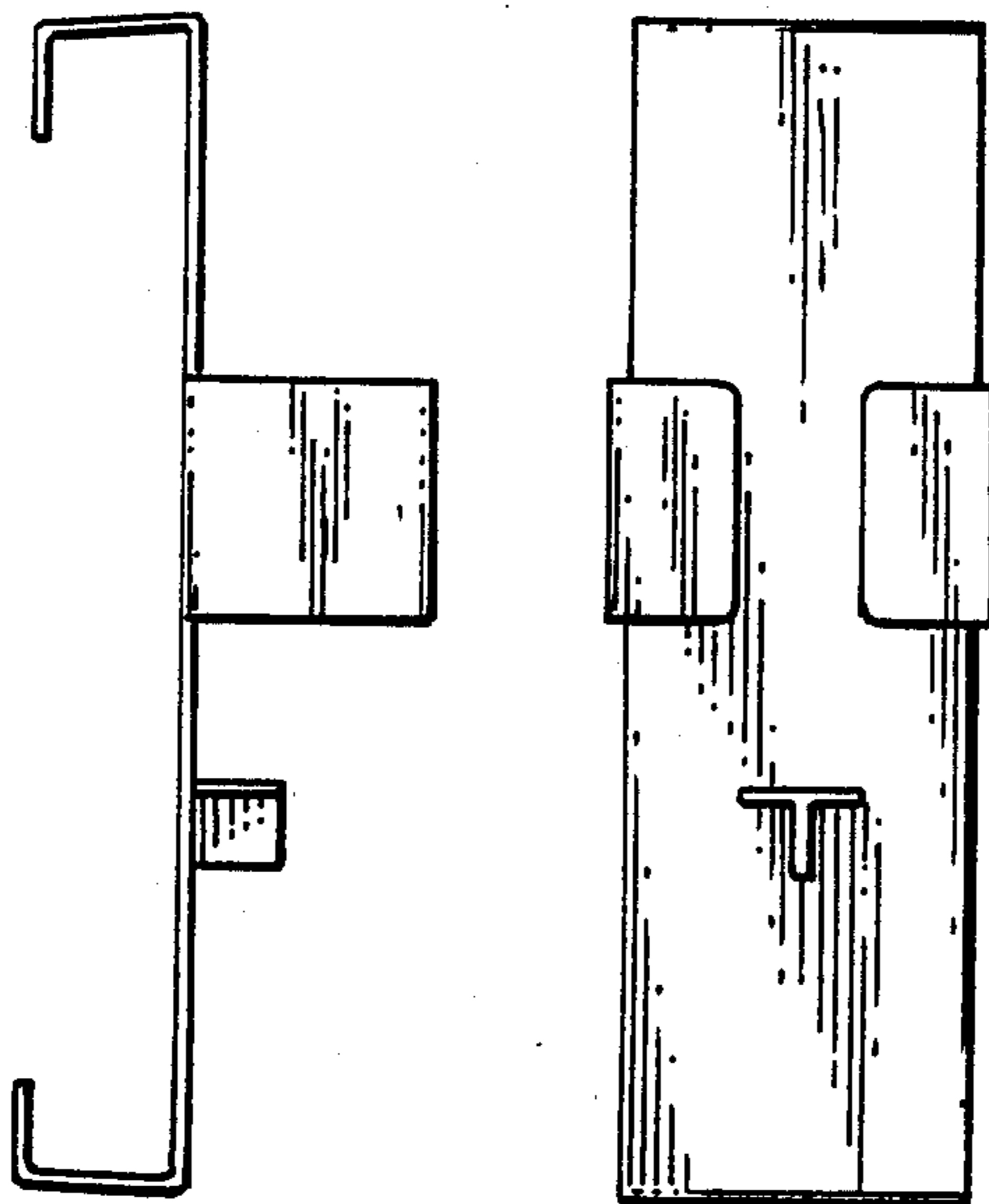

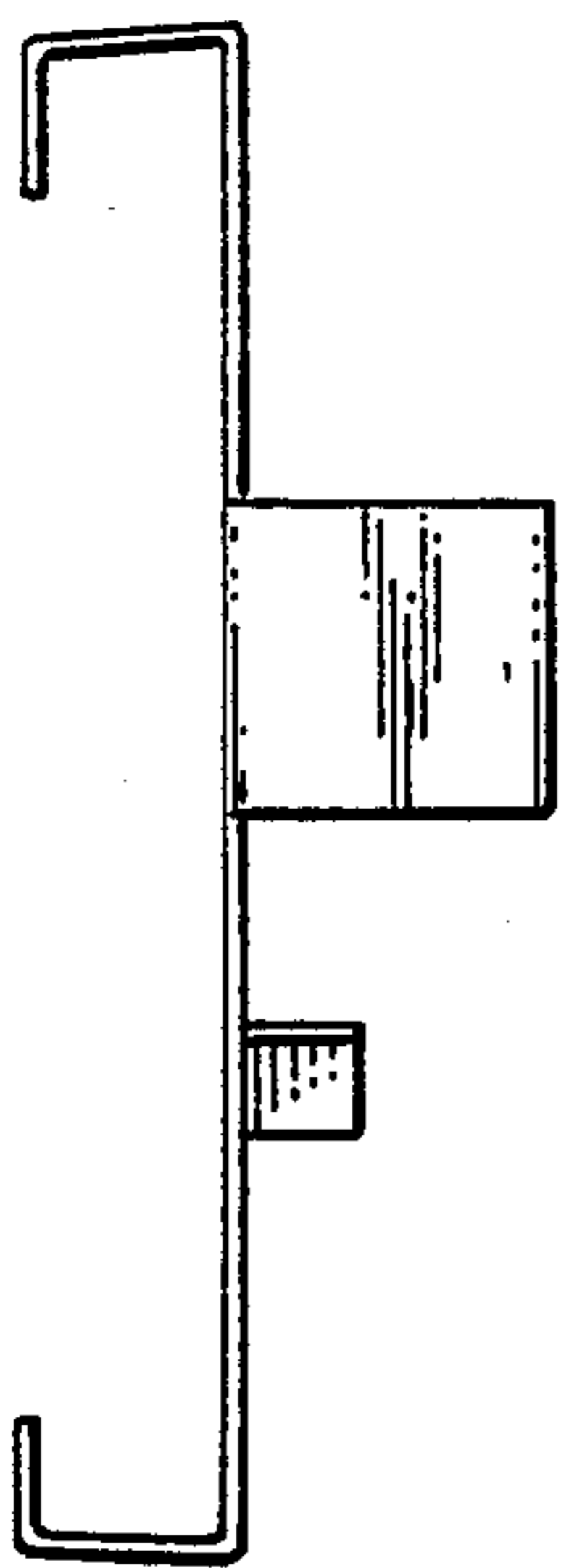
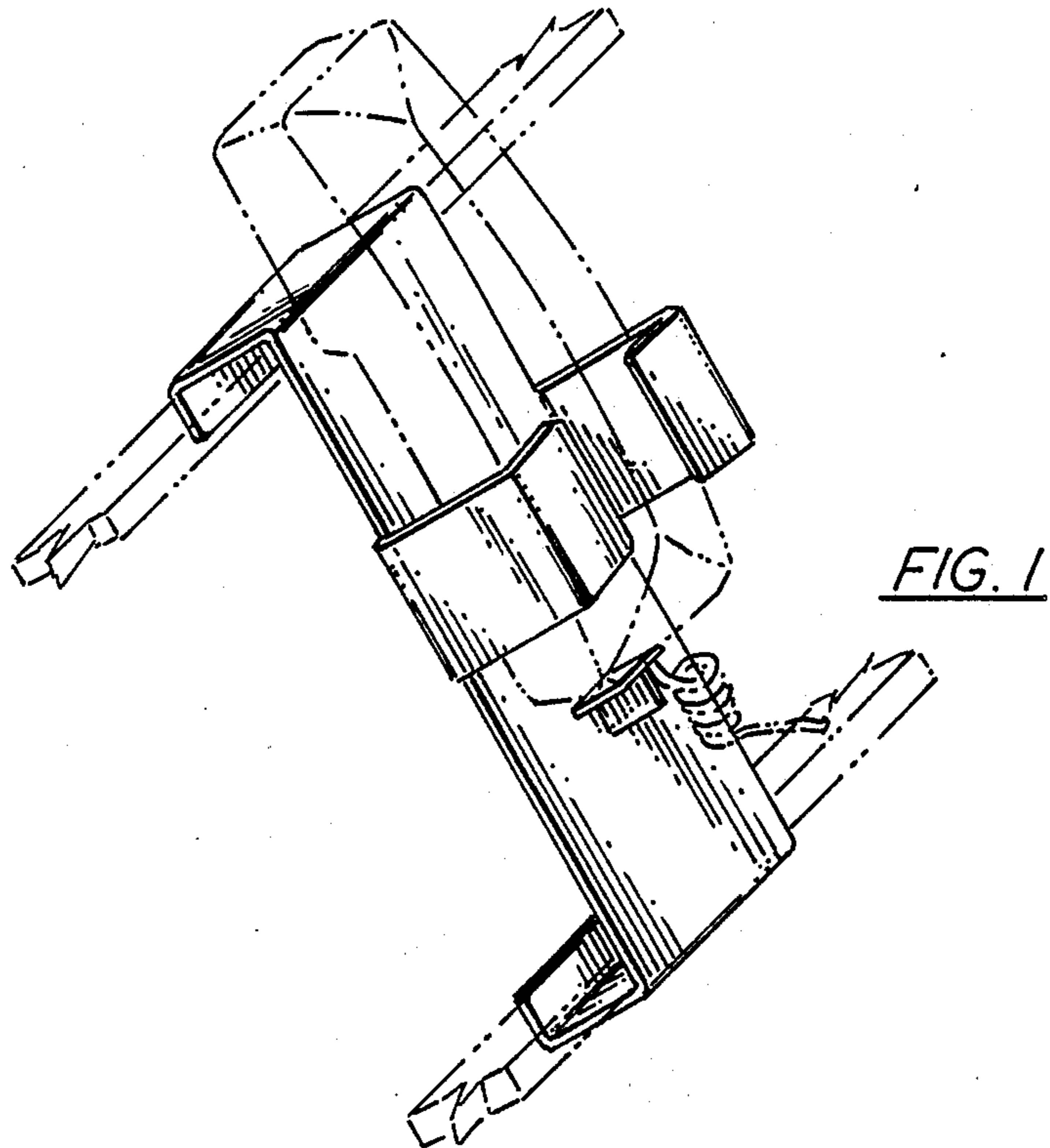

FIG. 5

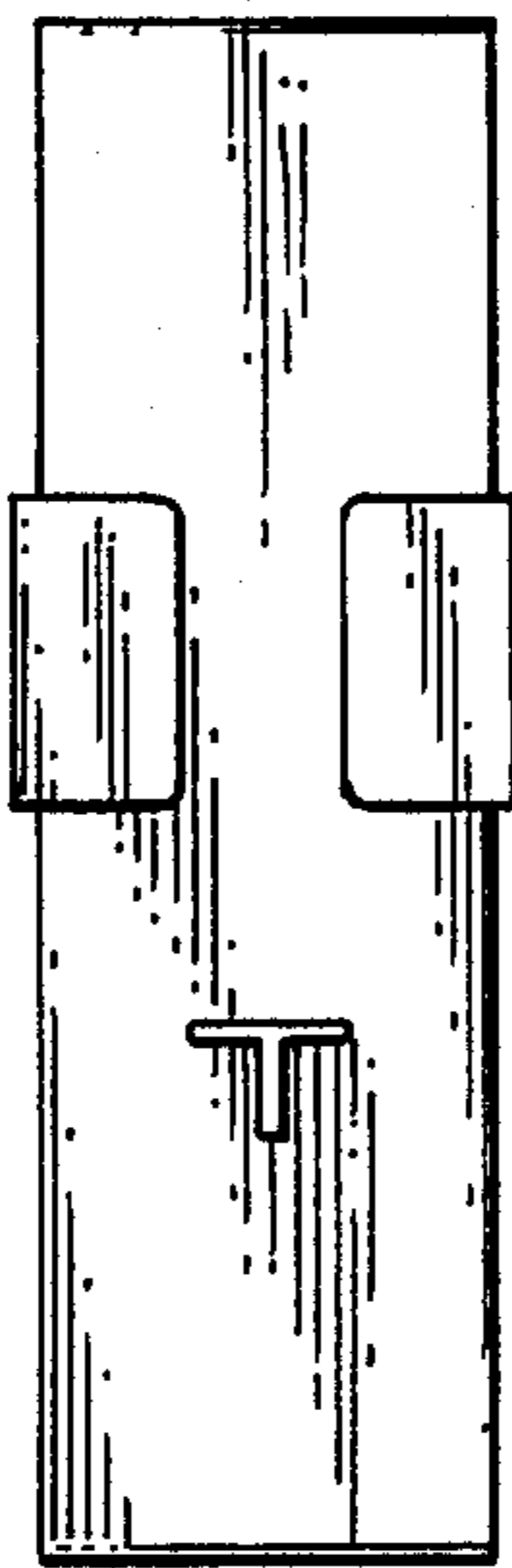

FIG. 2

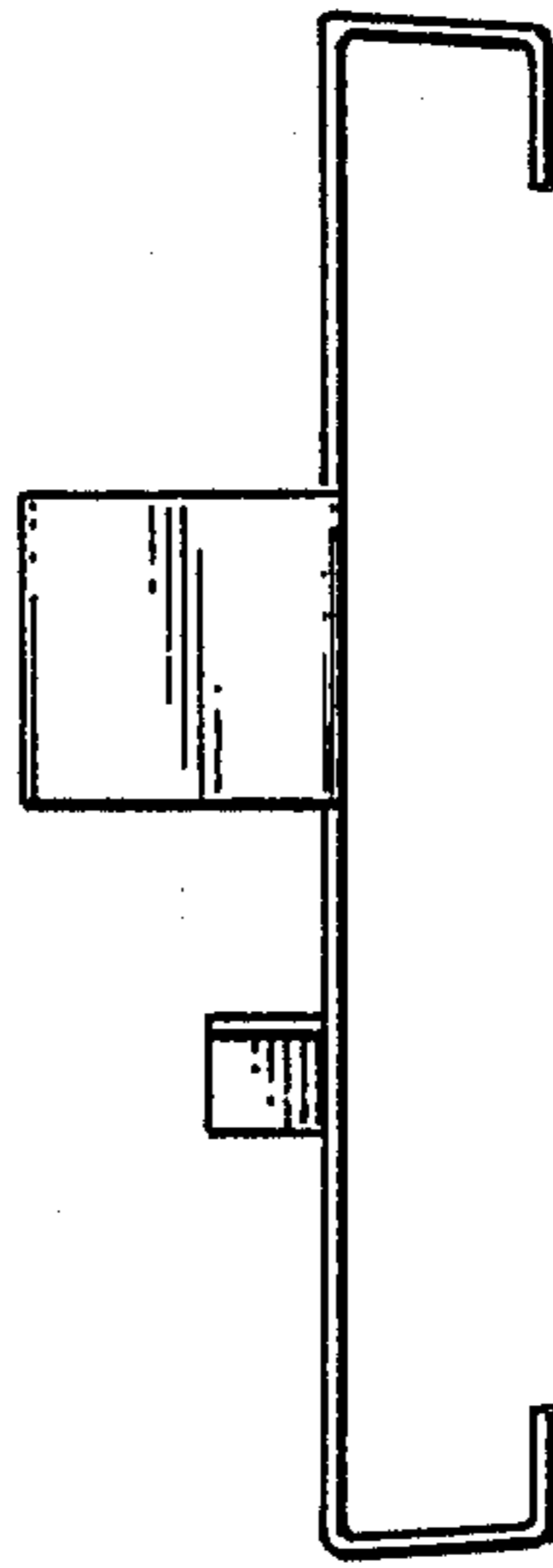

FIG. 3



FIG. 4

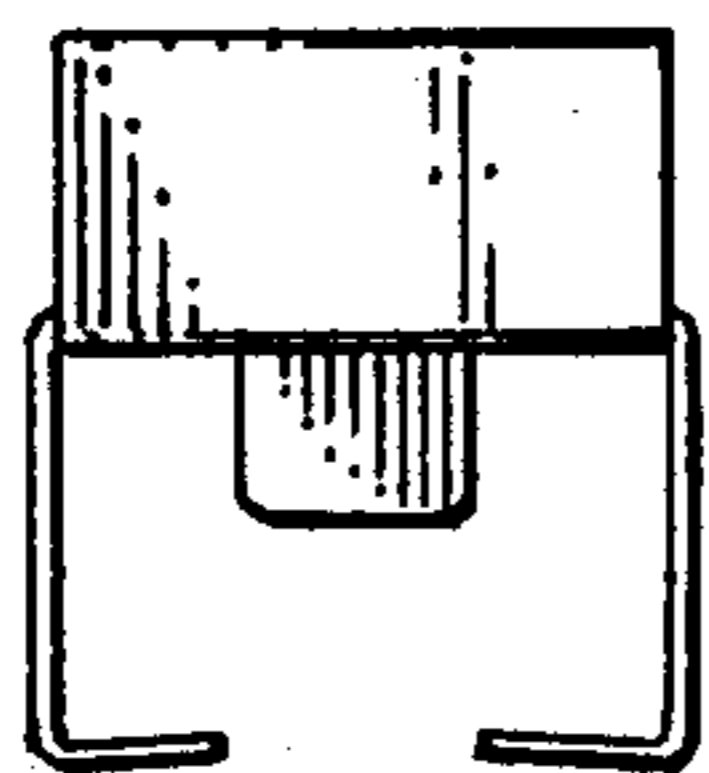

FIG. 6

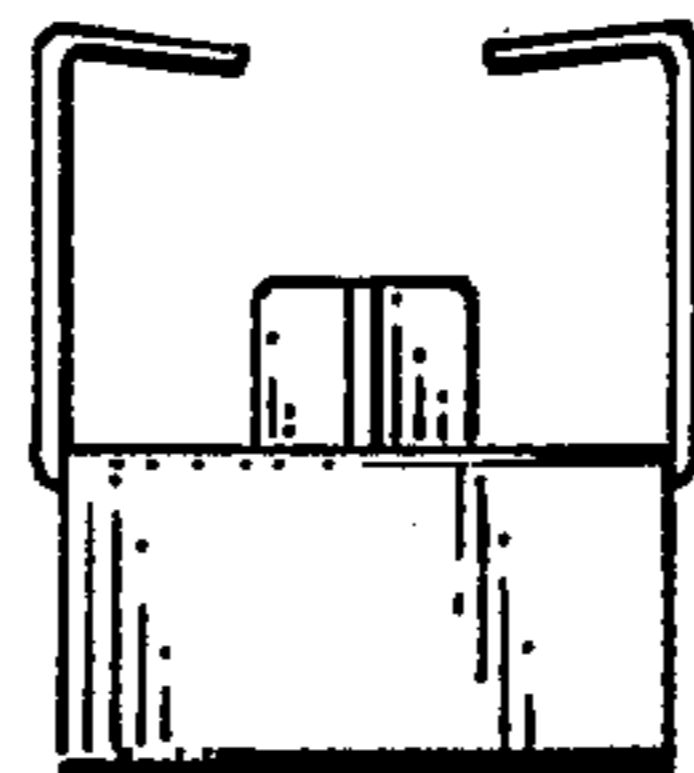

FIG. 7