

[54] **FOOD DISPENSER**

[76] **Inventor: Leif Stern, Fattershus, S-225 90  
Lund, Sweden**

[\*\*] **Term: 14 Years**

[21] **Appl. No.: 60,368**

[22] **Filed: Jun. 10, 1987**

[30] **Foreign Application Priority Data**

Dec. 11, 1986 [SE] Sweden ..... 862936

[52] **U.S. Cl. .... D7/590; D9/300**

[58] **Field of Search ..... D7/52, 300, 76; D9/447,  
D9/435, 300; 222/385, 142.5**

[56] **References Cited**

**U.S. PATENT DOCUMENTS**

D. 282,617 2/1986 Hogan ..... D7/52

*Primary Examiner*—Bernard Ansher  
*Assistant Examiner*—Terry A. Pfeffer  
*Attorney, Agent, or Firm*—Foley & Lardner, Schwartz,  
Jeffery, Schwaab, Mack, Blumenthal & Evans

[57] **CLAIM**

The ornamental design for a food dispenser, as shown and described.

**DESCRIPTION**

FIG. 1 is a perspective view of the food dispenser showing my new design;

FIG. 2 is a right side elevational view thereof;

FIG. 3 is a left side elevational view thereof;

FIG. 4 is a top plan view thereof;

FIG. 5 is a bottom plan view thereof;

FIG. 6 is a front elevational view thereof;

FIG. 7 is a rear elevational view thereof.

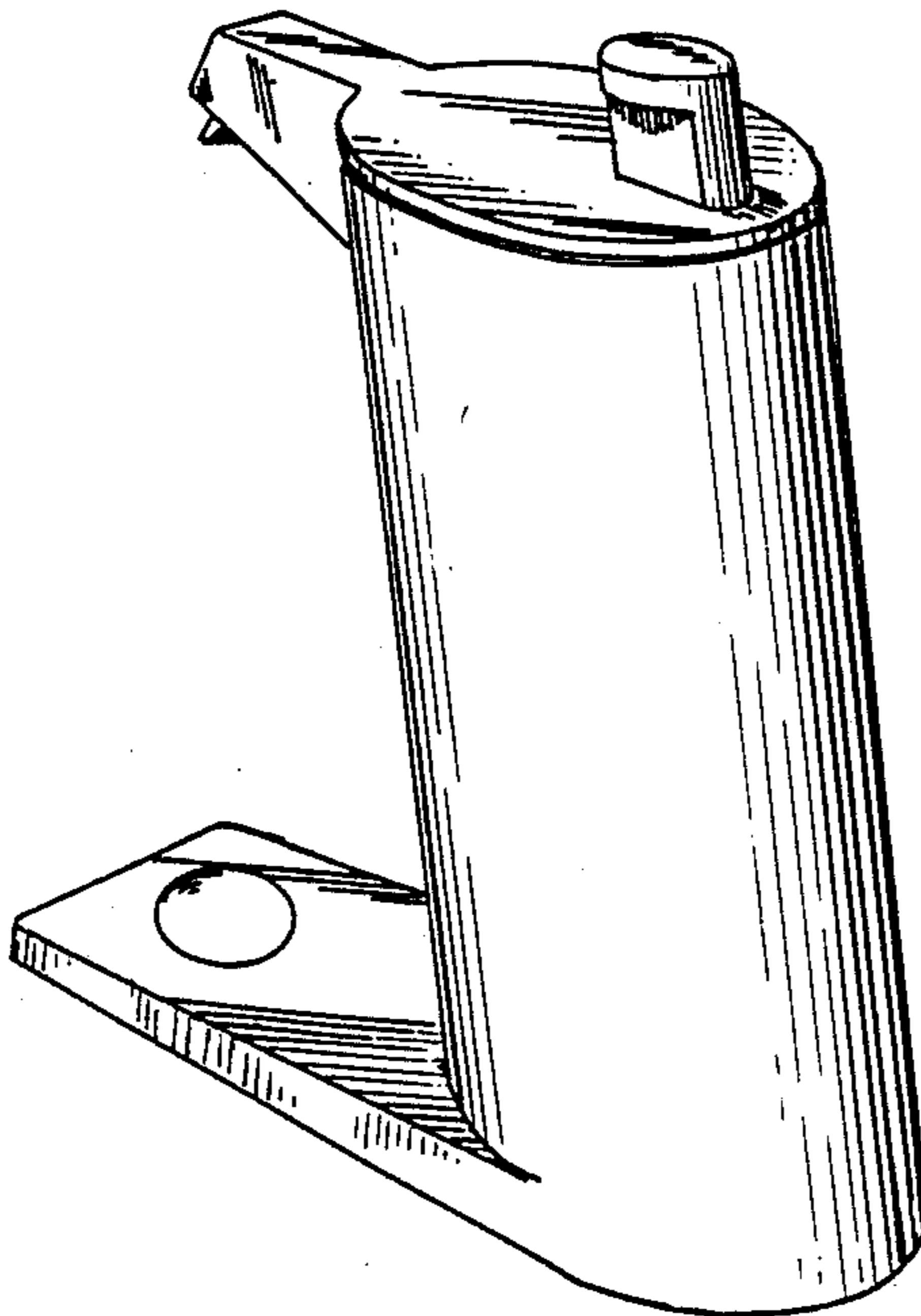

FIG. 1

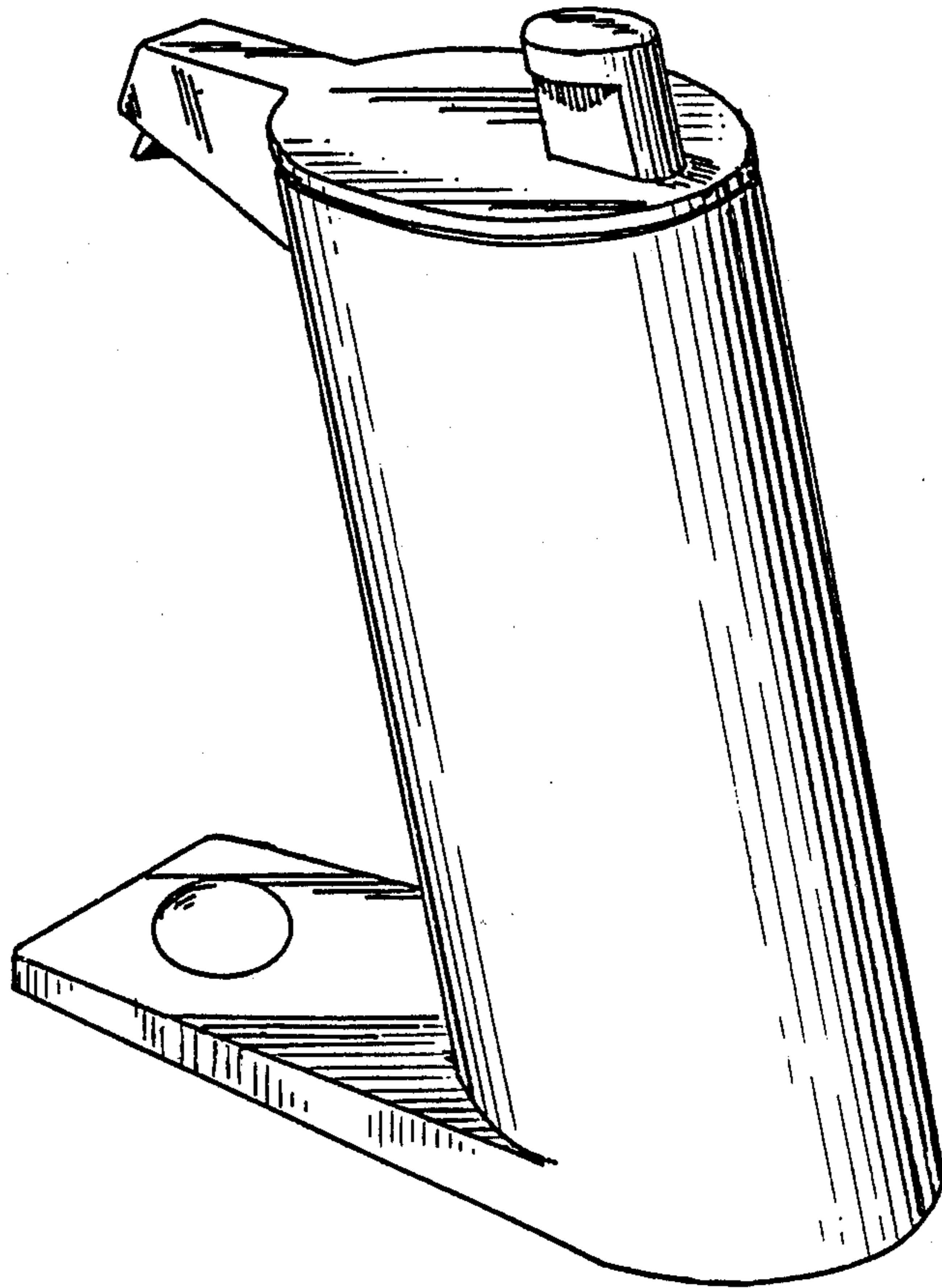

FIG.3

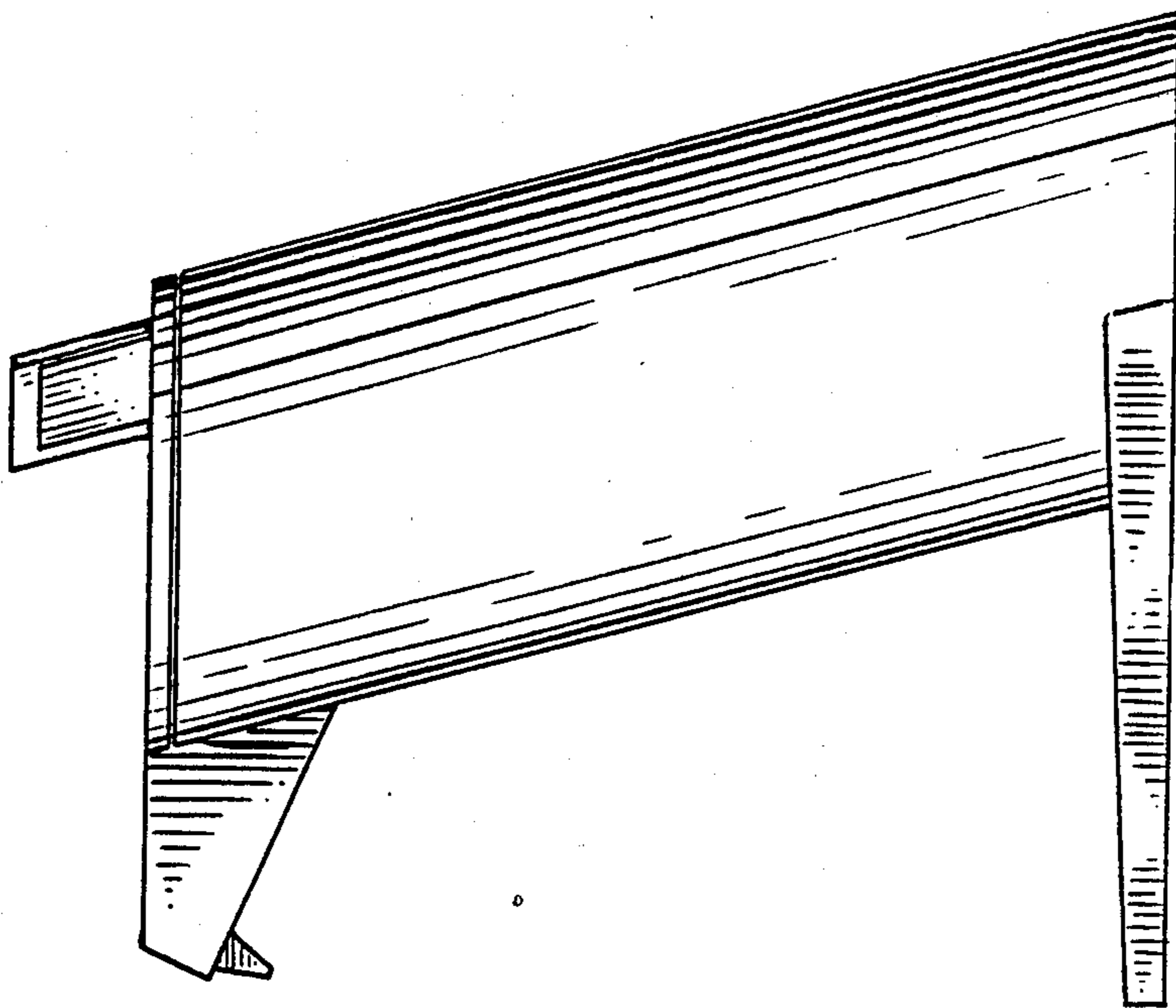

FIG.2

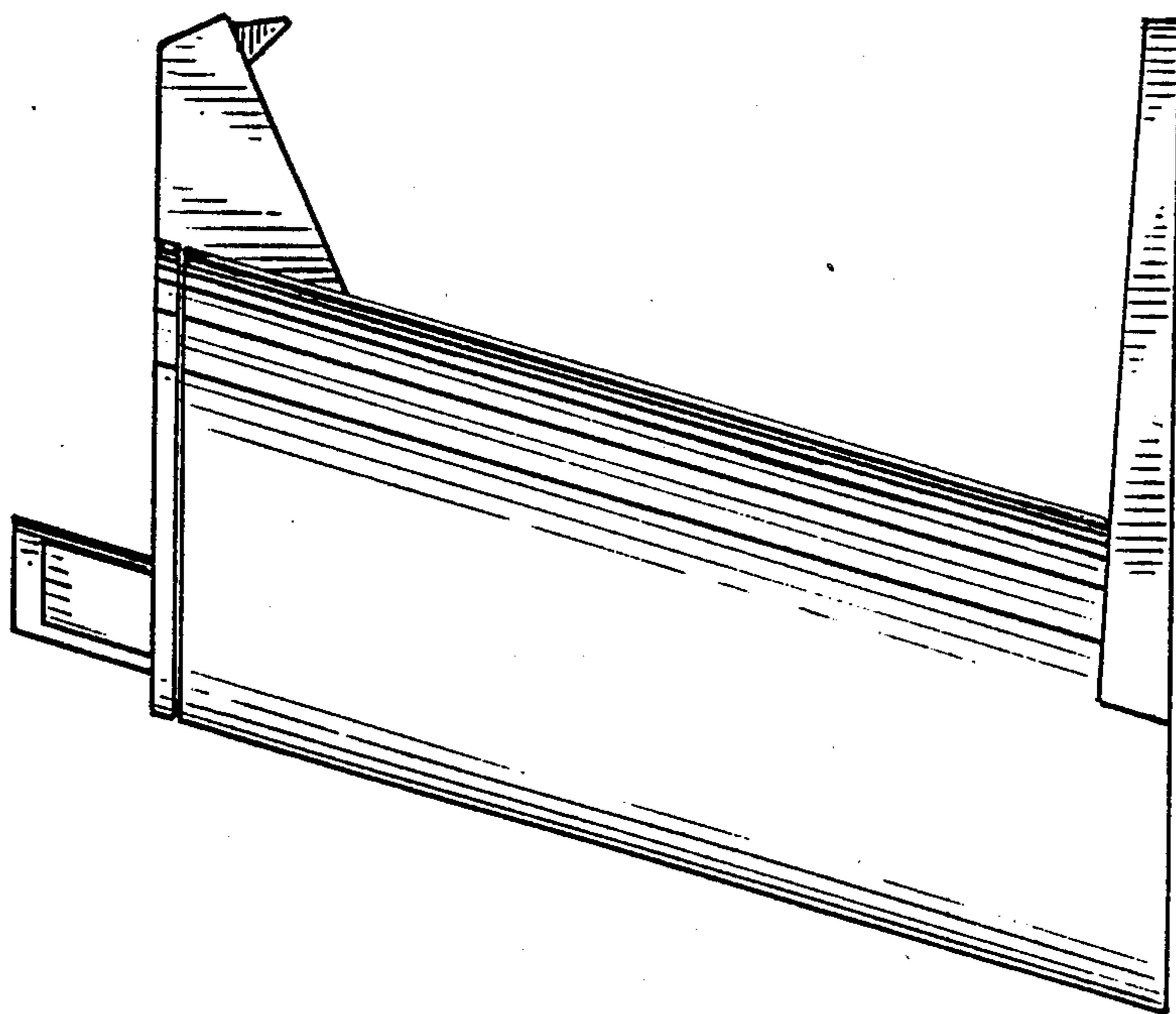

FIG. 4

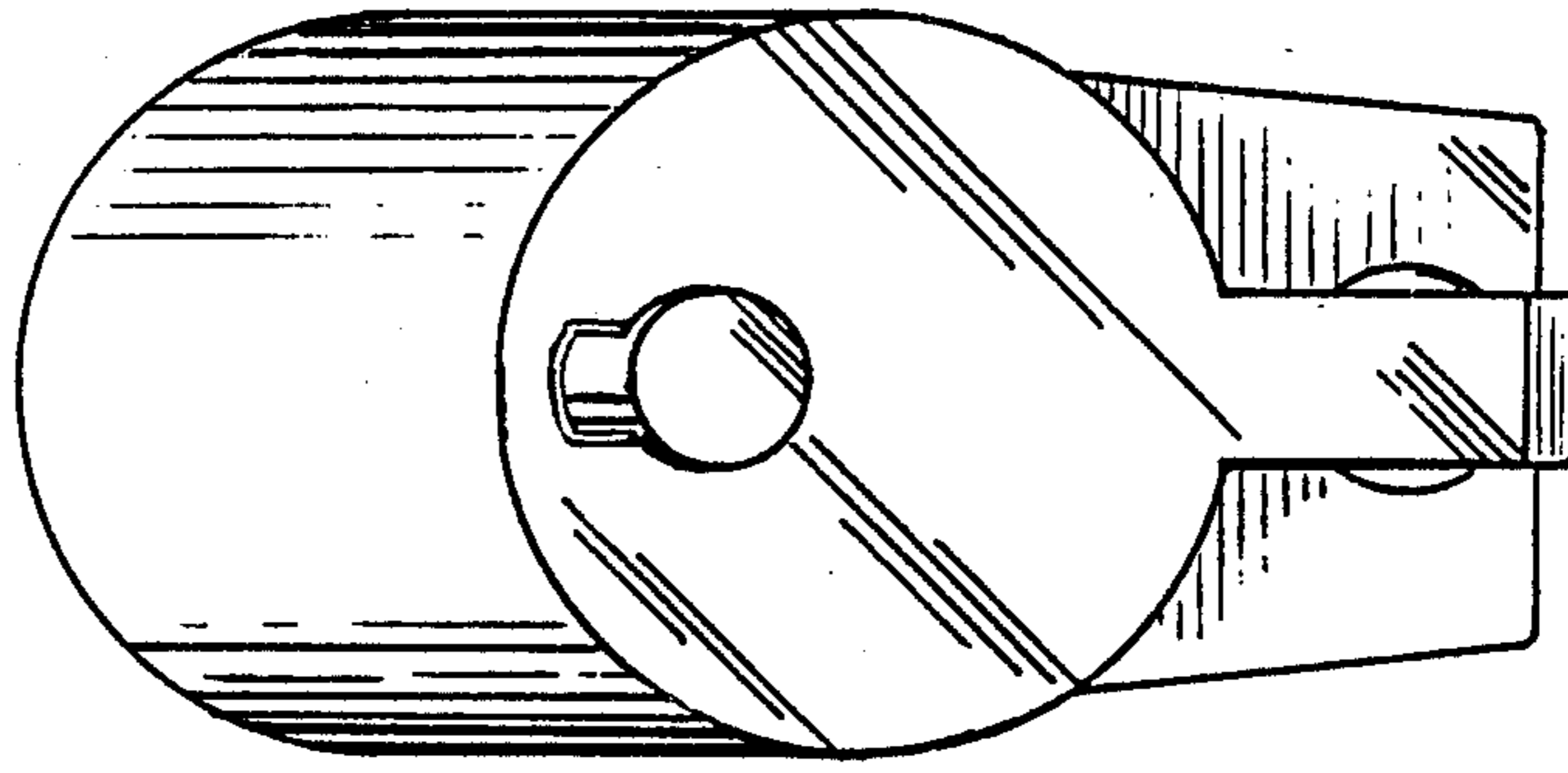

FIG. 5

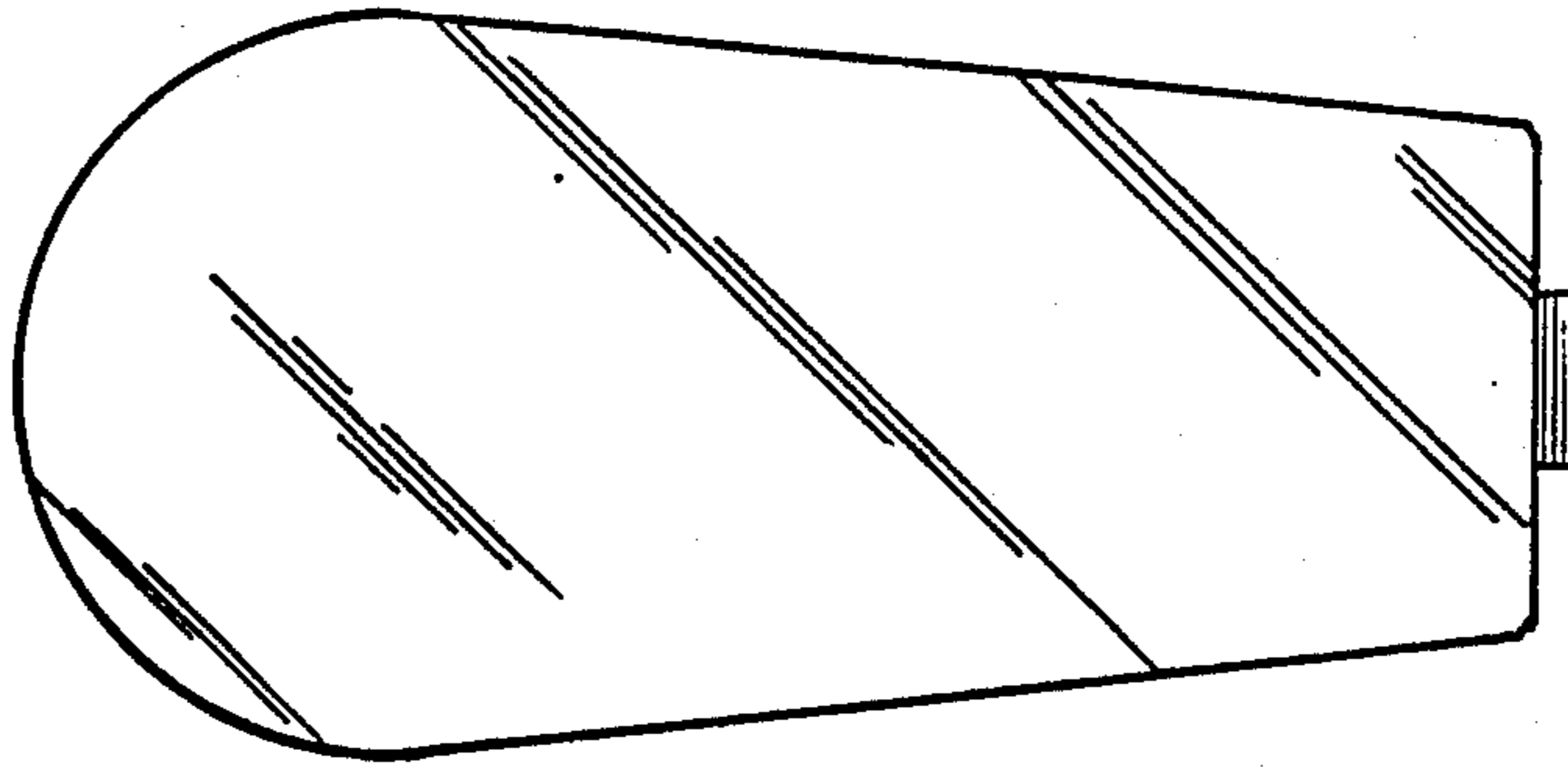

FIG. 7

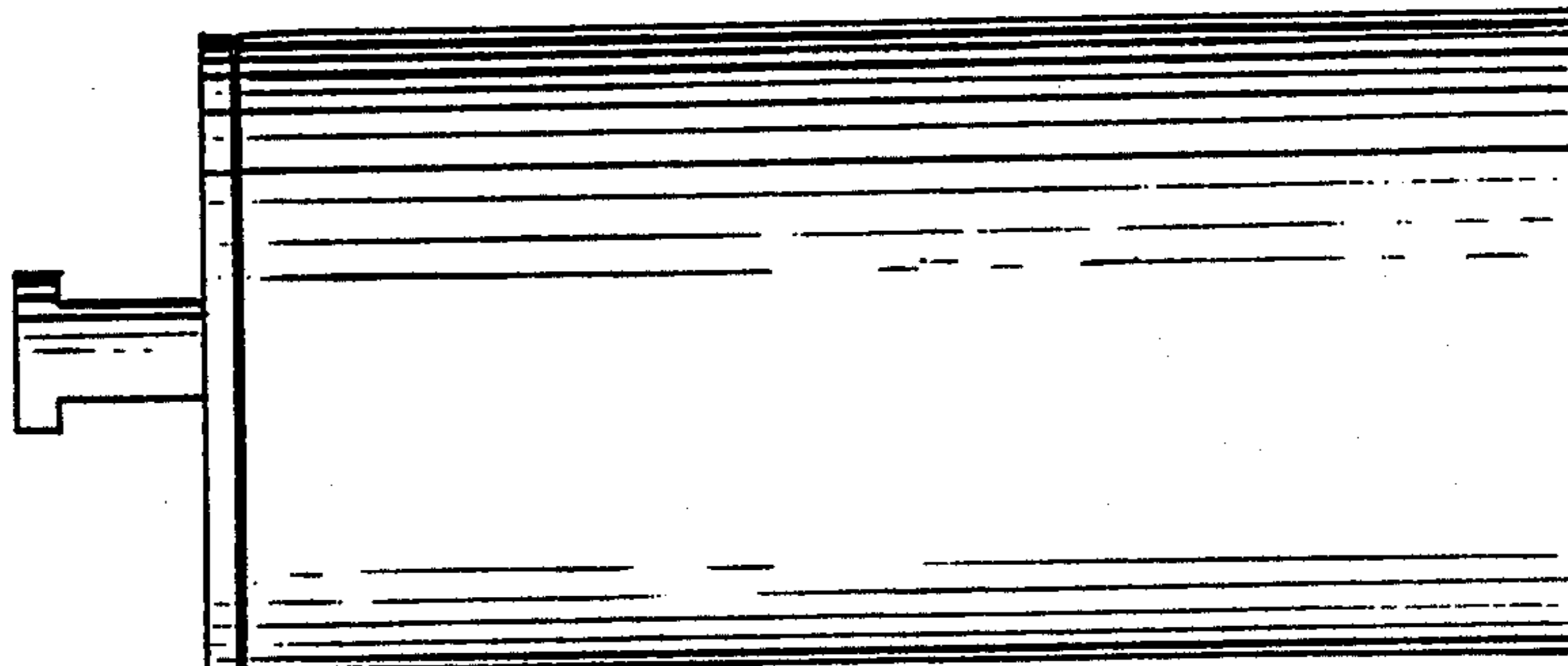

FIG. 6

