

[54] GAME

[56]

References Cited

[75] Inventor: Kohichi Kojima, Tokyo, Japan

[73] Assignee: Tomy Company, Ltd., Tokyo, Japan

[**] Term: 14 Years

[21] Appl. No.: 24,406

[22] Filed: Mar. 11, 1987

[30] Foreign Application Priority Data

Sep. 13, 1986 [JP] Japan 61-36248
 [52] U.S. Cl. D21/13
 [58] Field of Search D13/12, 32; D18/7;
 D19/59, 60; D21/13, 48; 273/1 E, 1 GC, 1 GE,
 85 G, 85 R, 85 CP, 88, 94, 148 B, 237, DIG. 28

U.S. PATENT DOCUMENTS

D. 265,571	7/1982	Nagel	D21/13
4,200,284	4/1980	Kaga	273/1 GE
4,309,030	1/1982	Goldfarb et al.	273/1 GC
4,363,482	12/1982	Goldfarb	273/85 G

Primary Examiner—Charles A. Rademaker
 Assistant Examiner—Alicia A. Farrell
 Attorney, Agent, or Firm—Staas & Halsey

[57] CLAIM

The ornamental design for a game, as shown.

DESCRIPTION

FIG. 1 is a front elevational view of a game showing my new design;
 FIG. 2 is a rear elevational view thereof;
 FIG. 3 is a right side elevational view thereof;
 FIG. 4 is a left side elevational view thereof;
 FIG. 5 is a top plan view thereof; and
 FIG. 6 is a bottom plan view thereof.

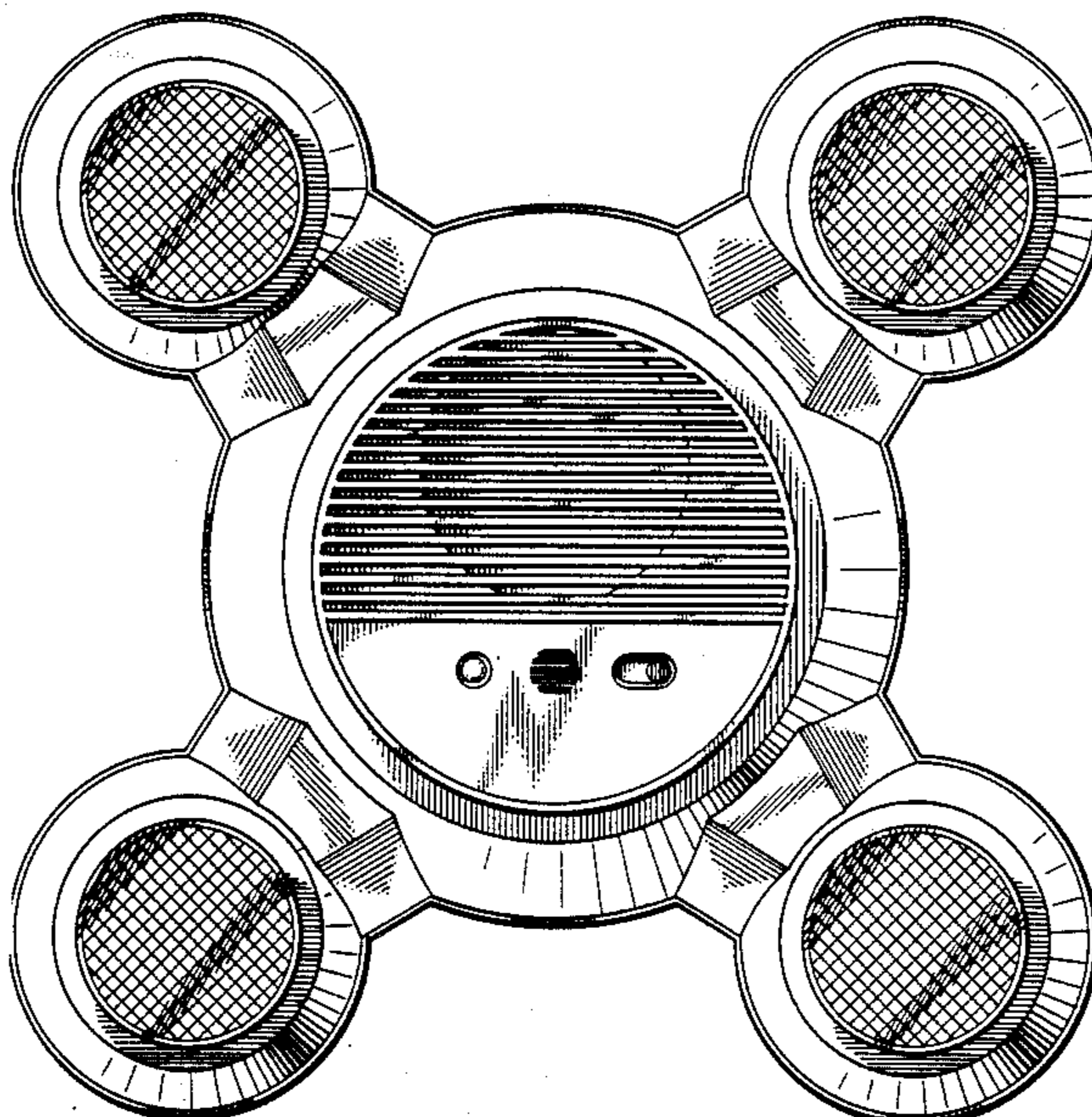
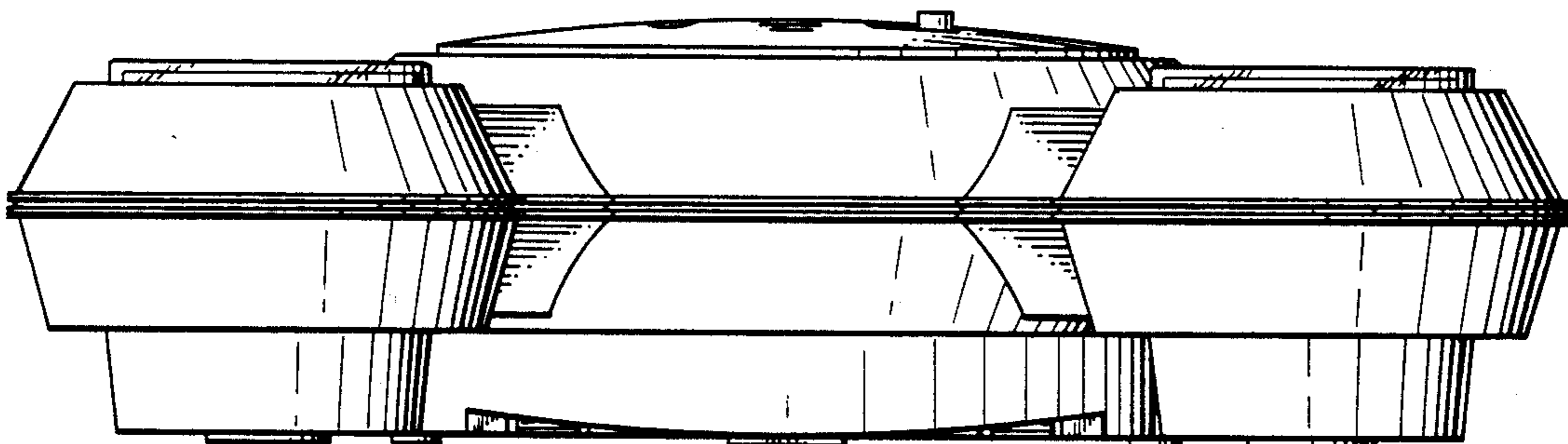

FIG. 1

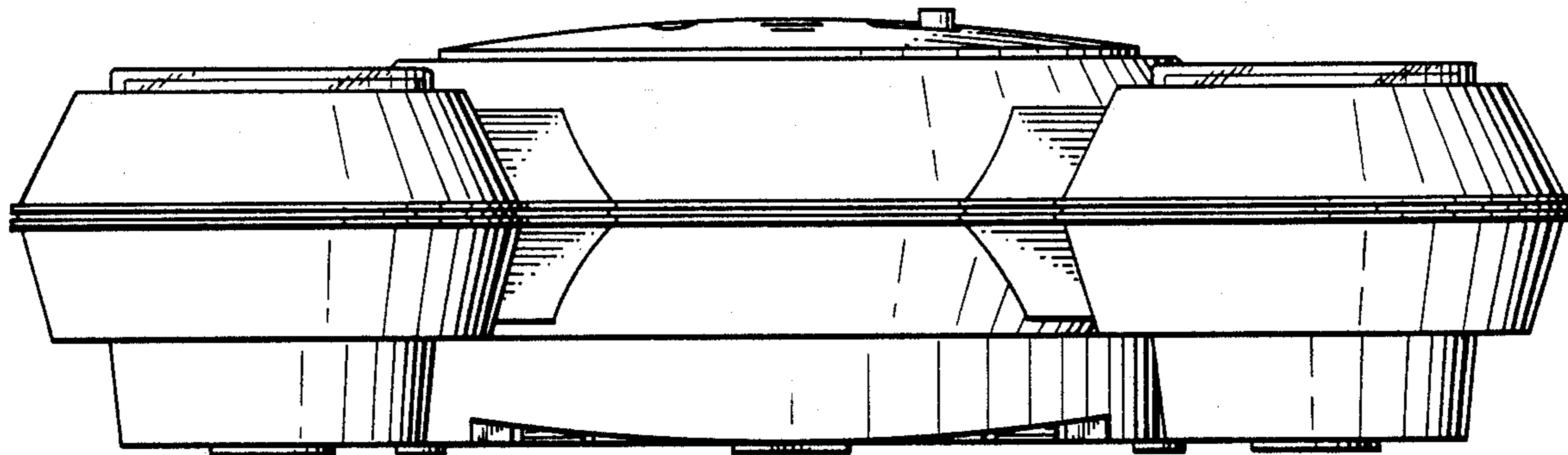

FIG. 2

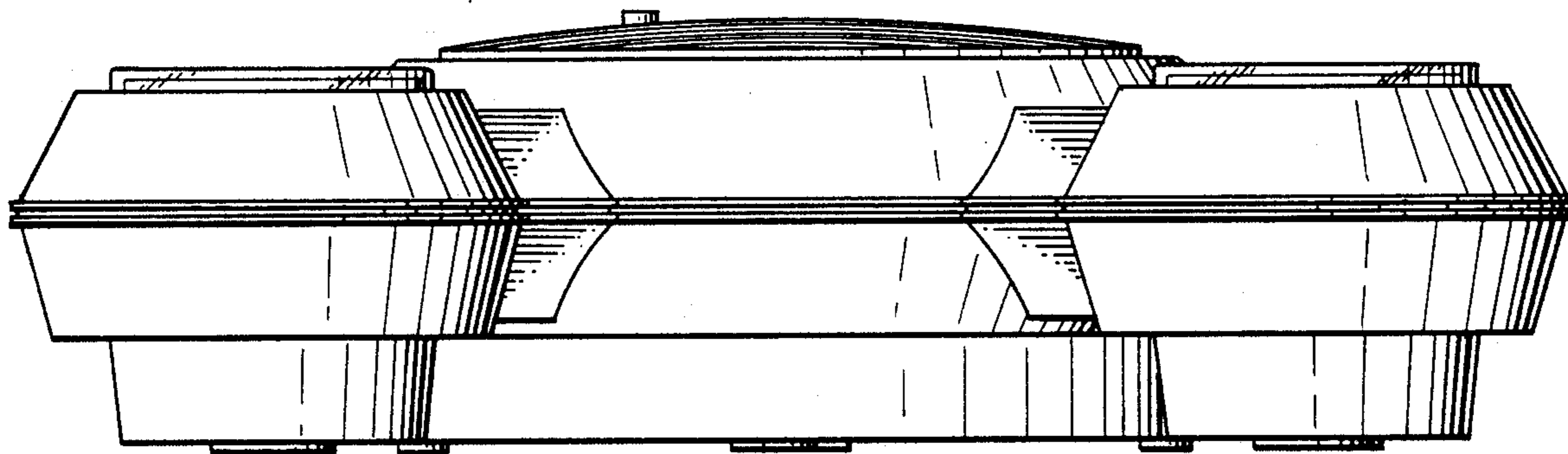

FIG. 3

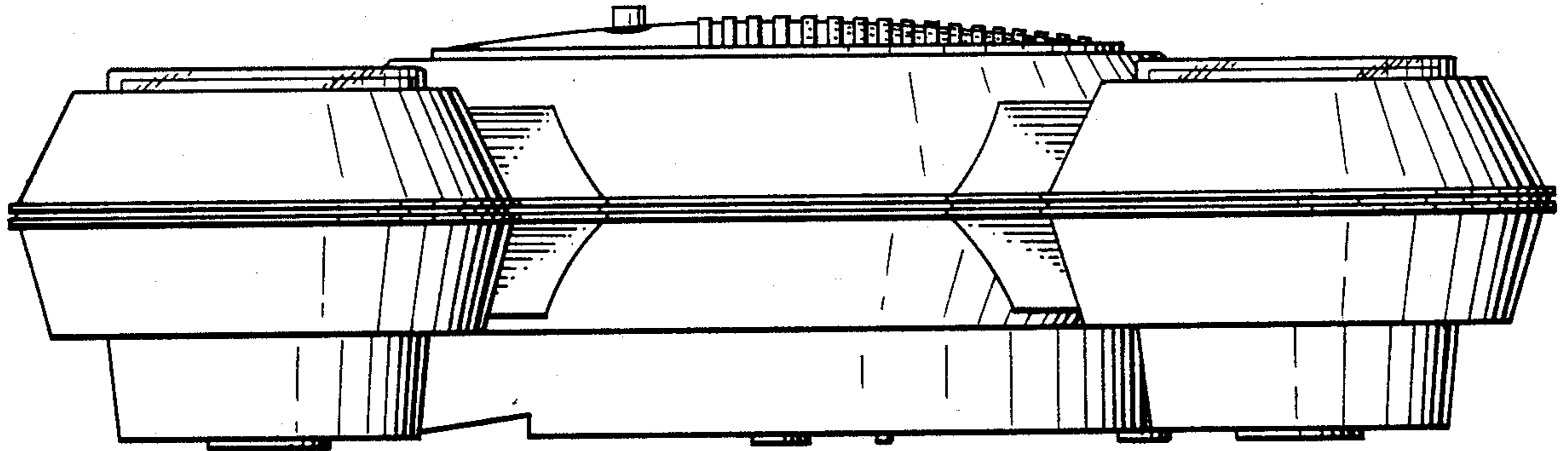

FIG. 4

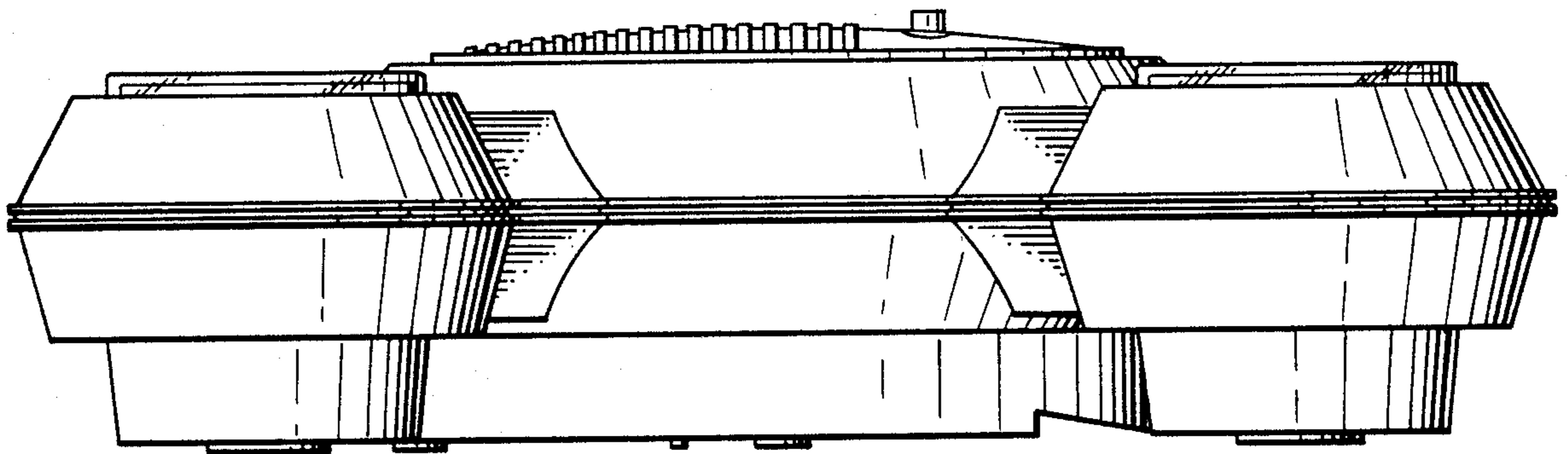

FIG. 5

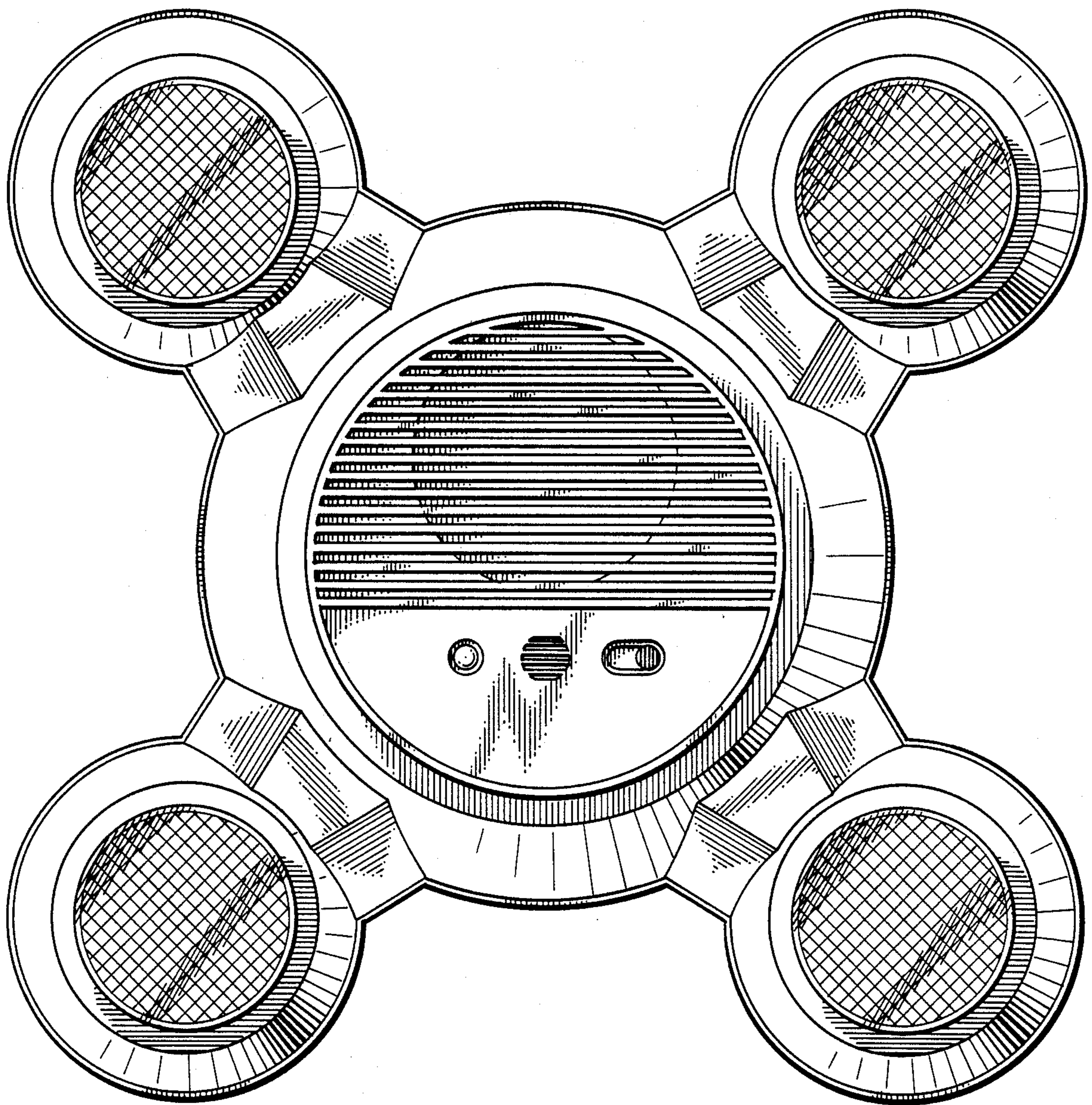

FIG. 6

