

- [54] ACCESSORY DRAWER FOR USE
PRIMARILY IN A MAILROOM
- [75] Inventors: Jane Ancona; Bruce Ancona, both of
New York, N.Y.
- [73] Assignee: M. Kamenstein, Inc., White Plains,
N.Y.
- [**] Term: 14 Years
- [21] Appl. No.: 461,765
- [22] Filed: Jan. 8, 1990
- [52] U.S. Cl. D19/75; D19/77;
D19/92; D19/95
- [58] Field of Search D19/22, 65, 75, 77,
D19/78, 92, 95, 100; 206/214, 224, 1.7-1.9, 371,
564; 190/32, 109

- D. 266,675 10/1982 Polhemus et al. D19/22
- D. 278,254 4/1985 Evenson D19/75
- D. 280,741 9/1985 Chatham D19/77
- D. 302,026 7/1989 Tu D19/75
- D. 305,246 12/1989 Kirchoff et al. D19/75
- 4,591,056 5/1986 Groch 206/564

Primary Examiner—Bruce W. Dunkins
 Assistant Examiner—Martha Thompson
 Attorney, Agent, or Firm—Henry R. Lerner

[57] CLAIM

The ornamental design for a accessory drawer for use primarily in a mailroom, as shown.

DESCRIPTION

FIG. 1 is a perspective view of a accessory drawer for use primarily in a mailroom, showing our new design; FIG. 2 is a top plan view thereof; FIG. 3 is a front elevational view thereof; FIG. 4 is a right side elevational view thereof; FIG. 5 is a left side elevational view thereof; FIG. 6 is a rear elevational view thereof; and FIG. 7 is a bottom plan view thereof.

- [56] References Cited
- U.S. PATENT DOCUMENTS
- D. 195,392 6/1963 Parkinson D19/75
- D. 242,654 12/1976 Rawls D9/347
- D. 256,809 9/1980 Evenson D19/75

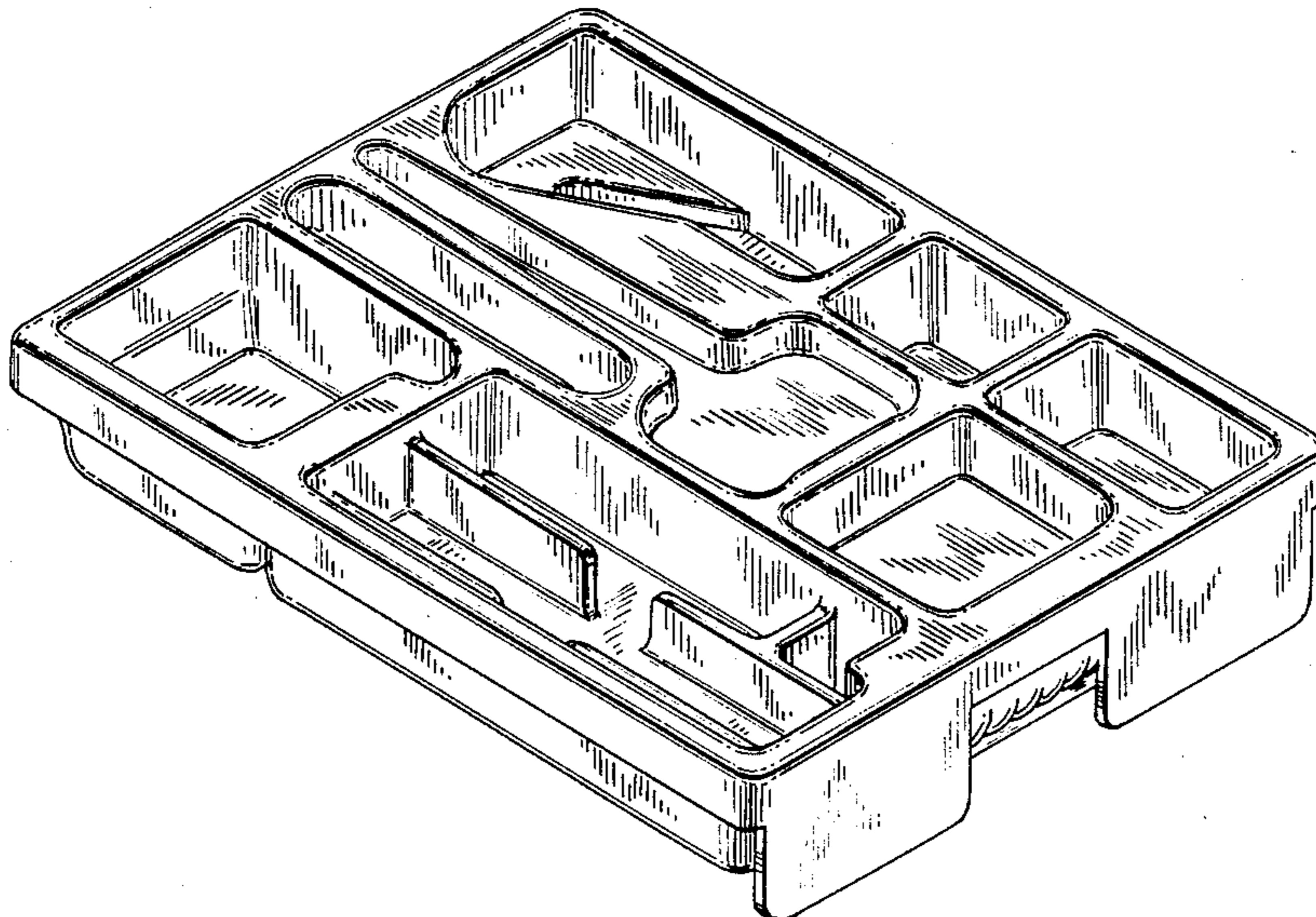

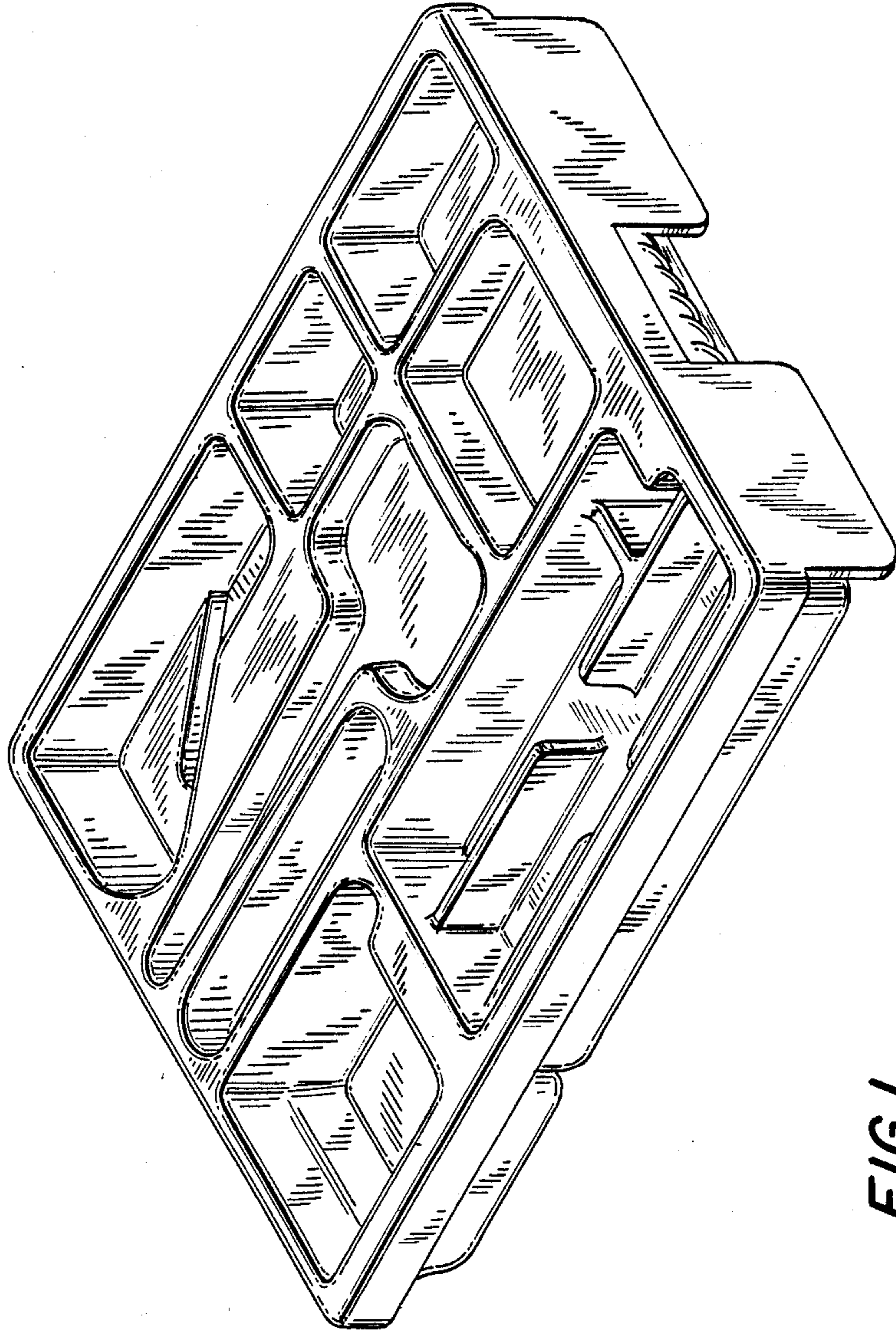

FIG. 1

FIG. 2

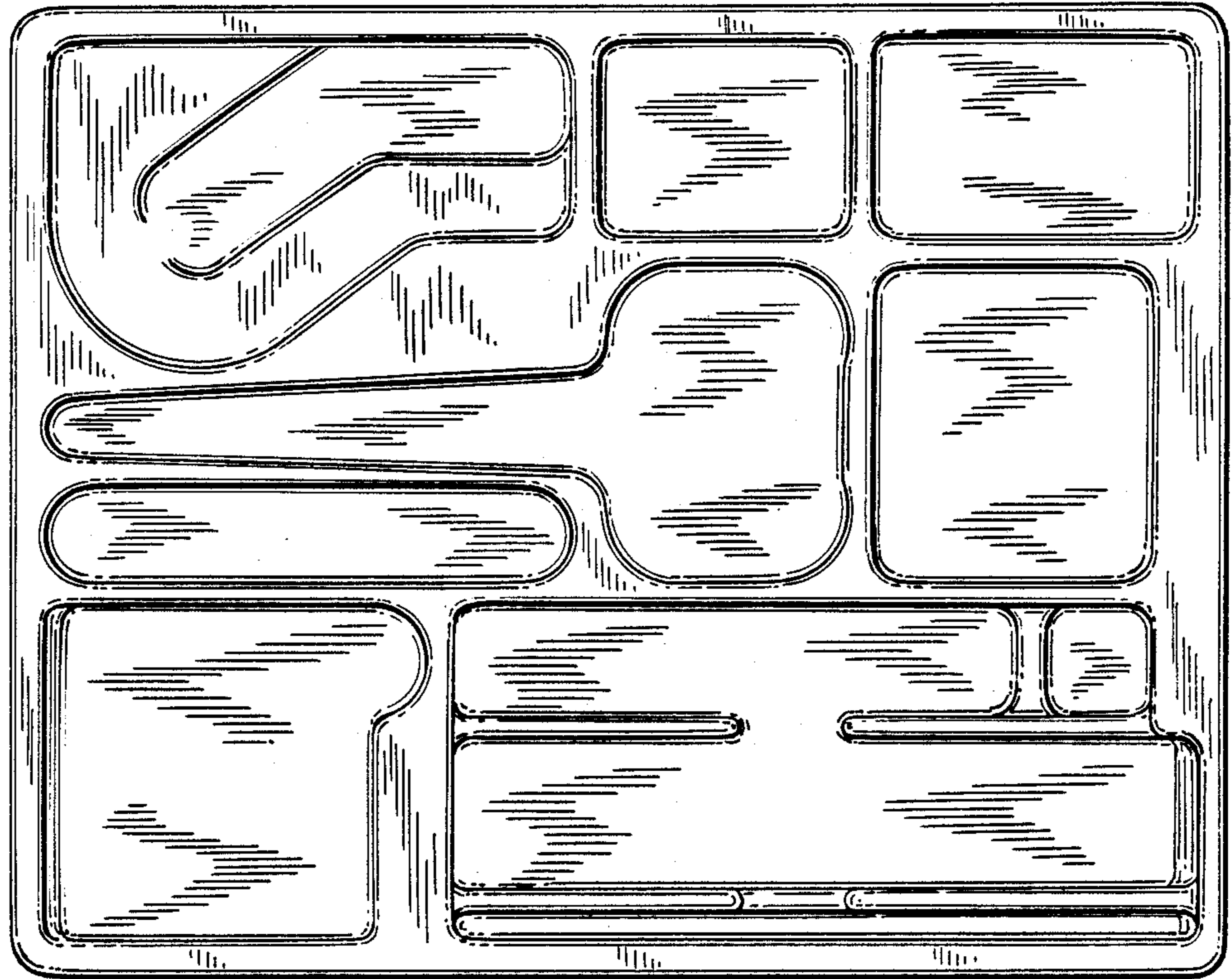

FIG. 3

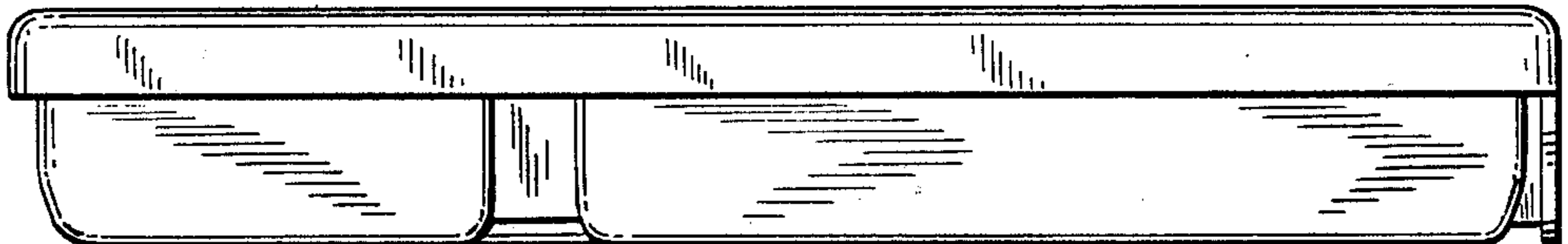

FIG. 4

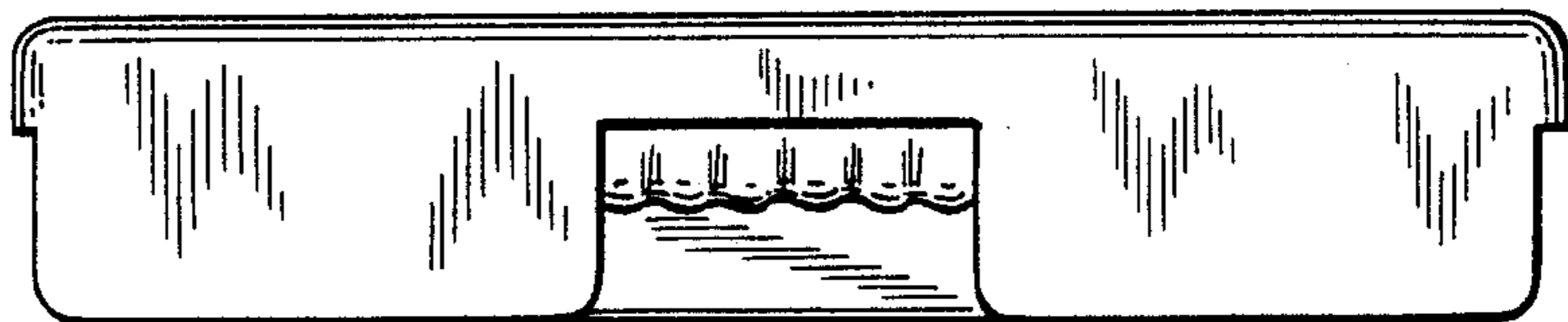

FIG. 5

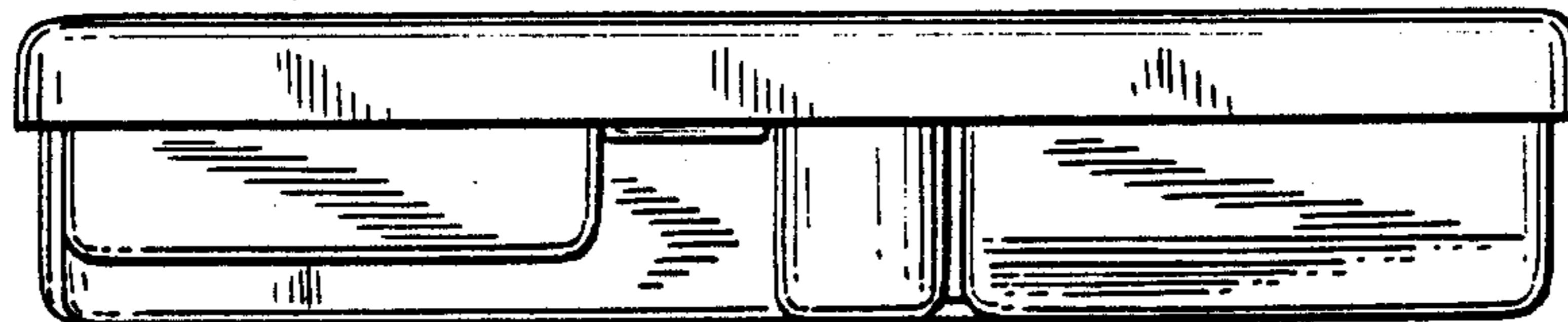

FIG. 6

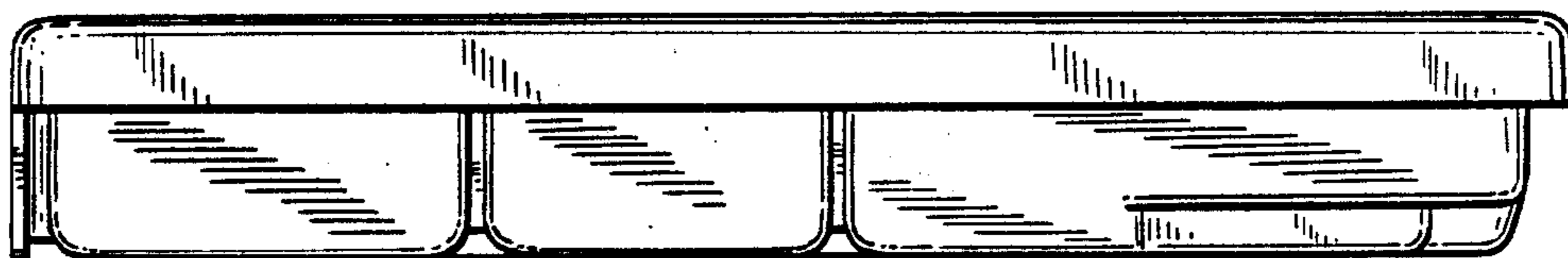

FIG. 7

