

[54] **TIE DOWN CLAMP FOR PICKUP TRUCKS**

[76] **Inventor: Robert D. Guffey, P.O. Box 4873,
 Helena, Mont. 59604**

[**] **Term: 14 Years**

[21] **Appl. No.: 249,165**

[22] **Filed: Sep. 26, 1988**

[52] **U.S. Cl. D8/356; D8/396**

[58] **Field of Search D8/396, 356, 354, 367;
 248/231.91, 316.8, 499; 410/107; 296/43;
 114/230**

[56] **References Cited**

U.S. PATENT DOCUMENTS

D. 226,856	5/1973	Leto et al.	D8/396 X
D. 239,364	3/1976	Mooney et al.	D8/396
D. 265,171	6/1982	Zukaitis	D8/356 X
887,889	5/1908	Worthington	296/43 X
2,608,167	8/1952	Harris	105/369
2,609,761	9/1952	Clark	105/369
2,638,063	5/1953	Clark	105/369
2,878,668	3/1959	Starling et al.	248/231.91 X
2,879,969	3/1959	Bamberger	248/361
3,595,125	7/1971	Jacobs	296/43 X

4,242,021	12/1980	Sloane	410/96
4,316,688	2/1982	Roskelley	410/107 X
4,403,378	9/1983	Engman	D8/396 X
4,531,774	7/1985	Whatley	296/43 X
4,657,299	4/1987	Mahan	296/43 X
4,685,646	8/1987	Harrison	248/225.31

FOREIGN PATENT DOCUMENTS

503746	6/1954	Canada	410/101 X
--------	--------	--------------	-----------

Primary Examiner—Horace B. Fay, Jr.
Attorney, Agent, or Firm—Fleit, Jacobson, Cohn, Price,
 Holman & Stern

[57] **CLAIM**

The ornamental design for tie down clamp for pickup trucks, as shown and described.

DESCRIPTION

FIG. 1 is a side elevational view of the tie down clamp for pickup trucks showing my new design.
 FIG. 2 is a front elevational view thereof.
 FIG. 3 is a rear elevational view thereof.
 FIG. 4 is a top plan view thereof.
 FIG. 5 is a bottom plan view thereof.
 FIG. 6 is a perspective view thereof from above.

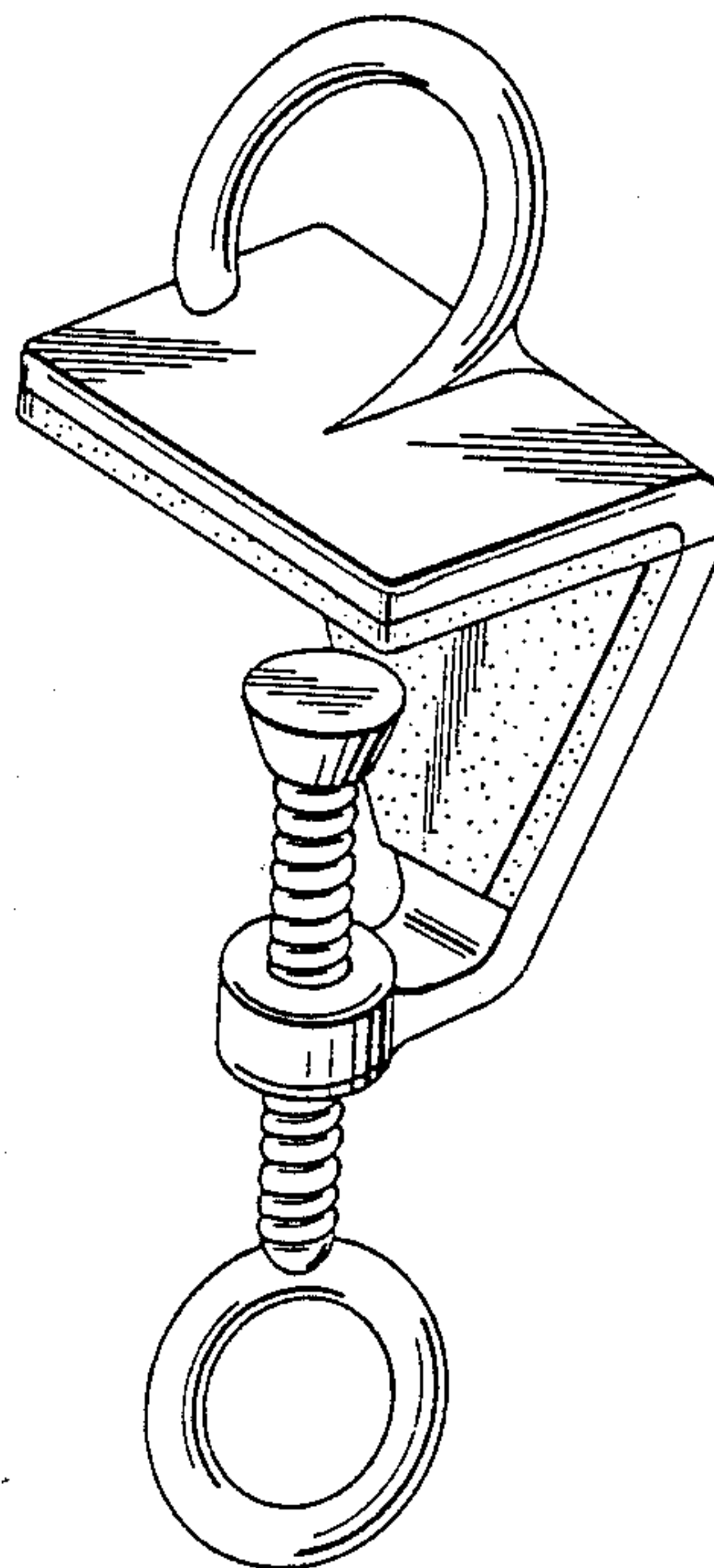
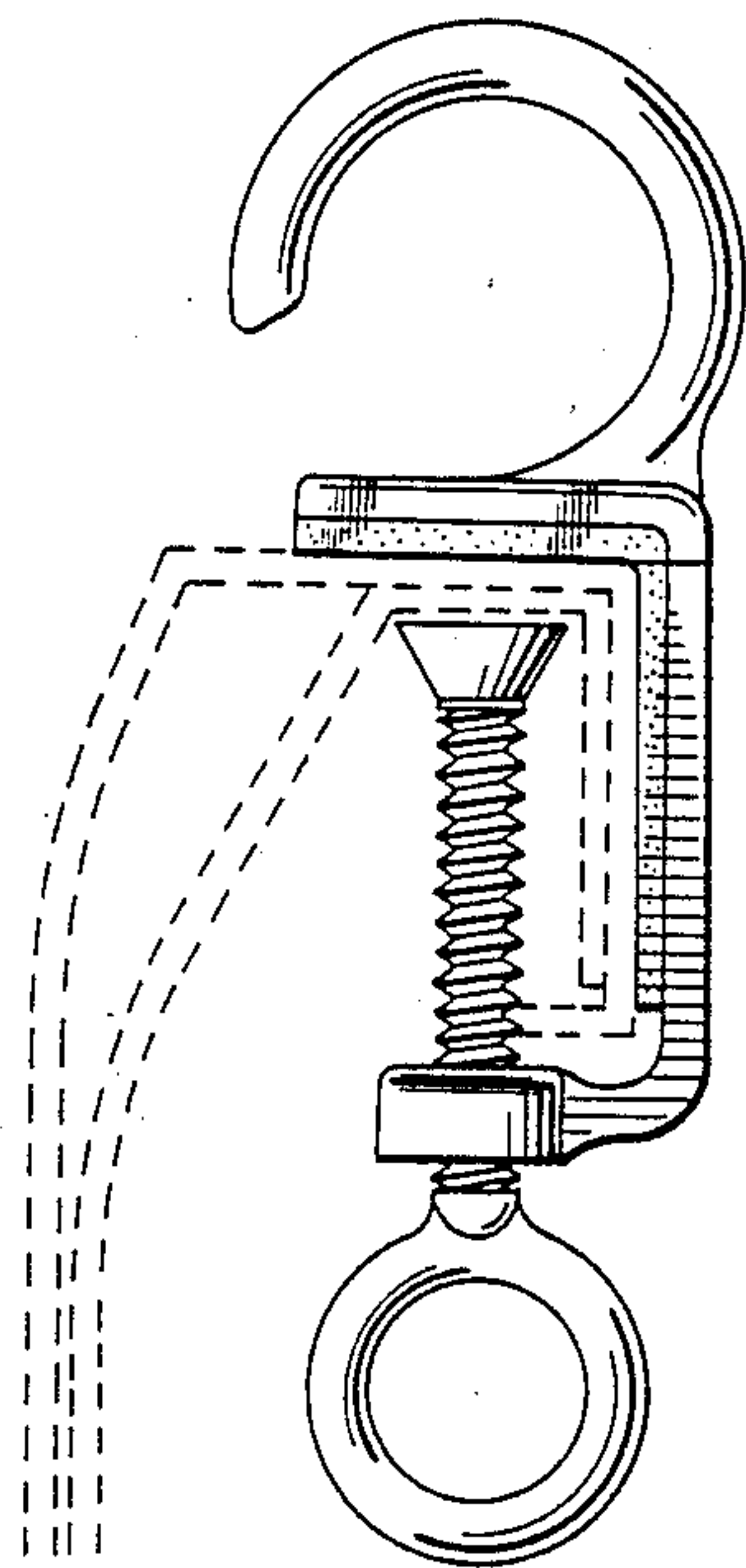

FIG. 1

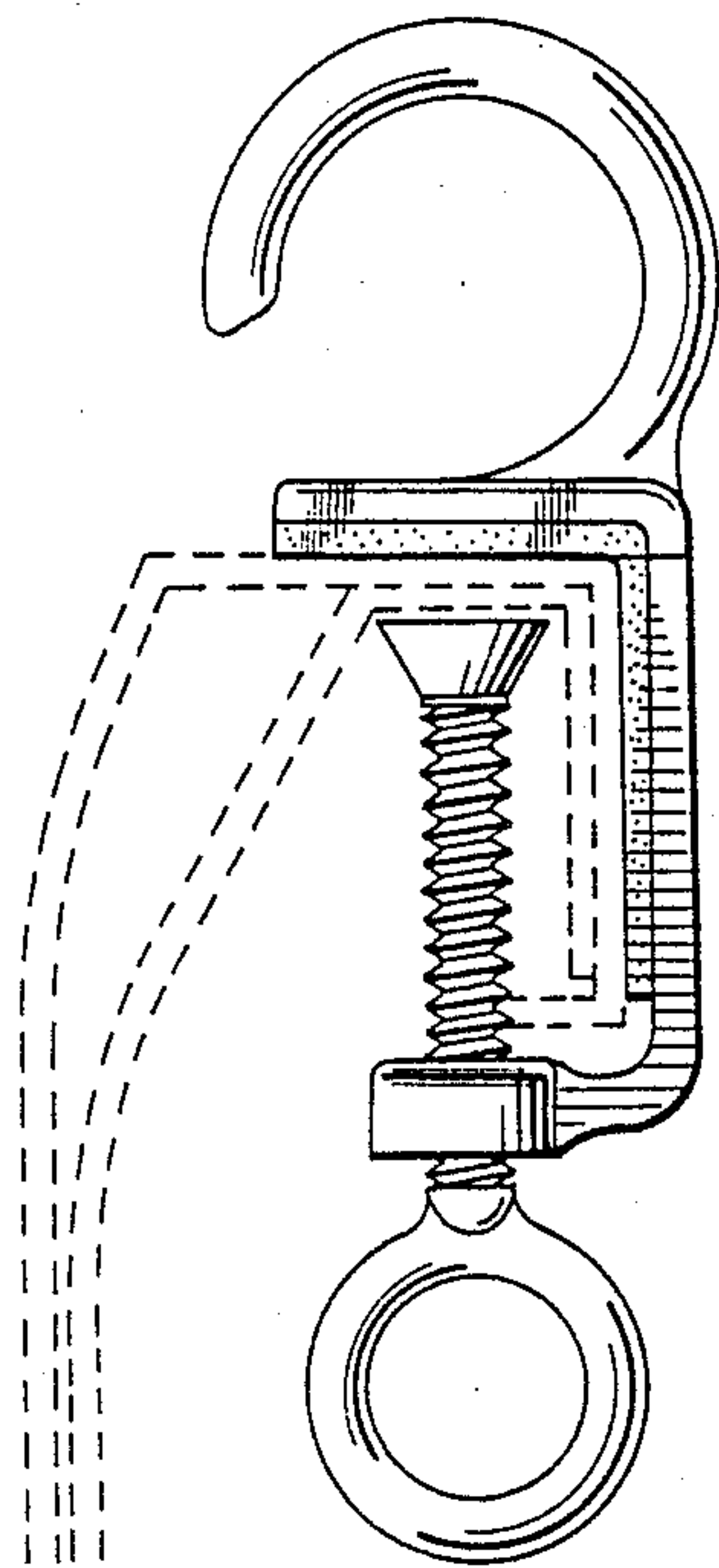

FIG. 2

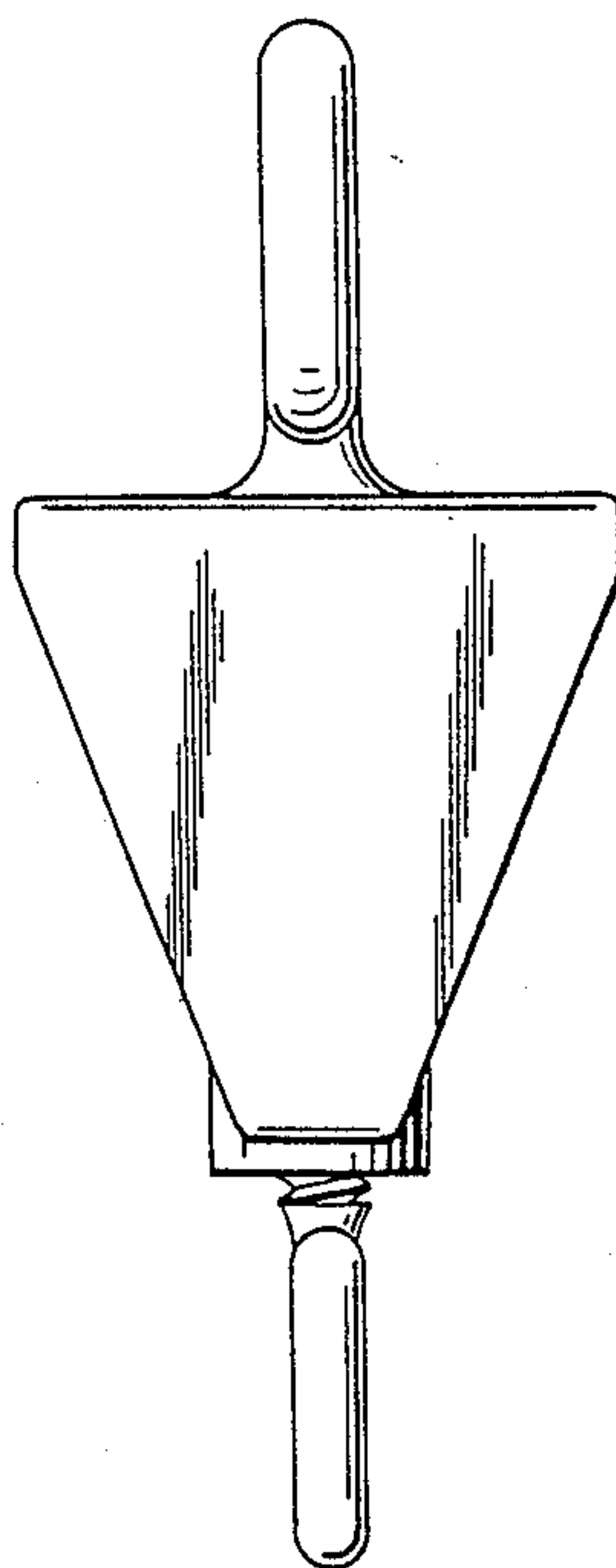

FIG. 3

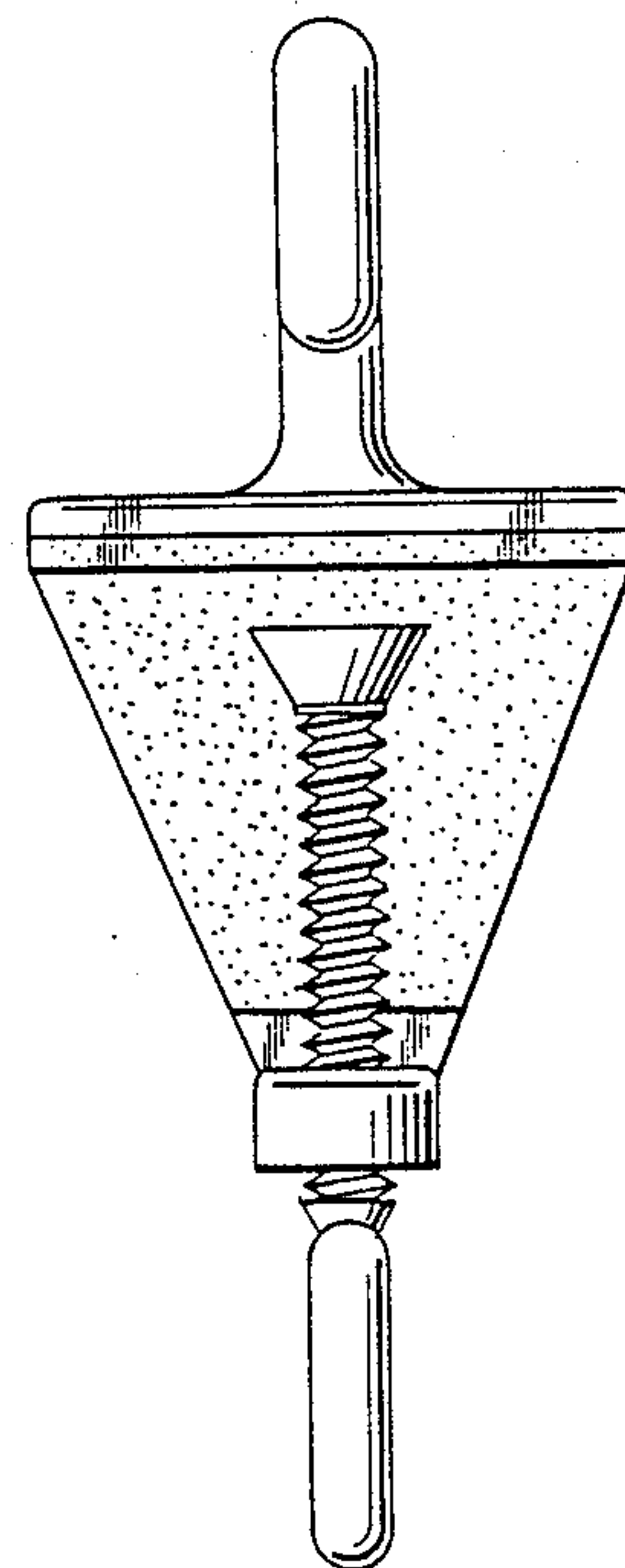

FIG. 4

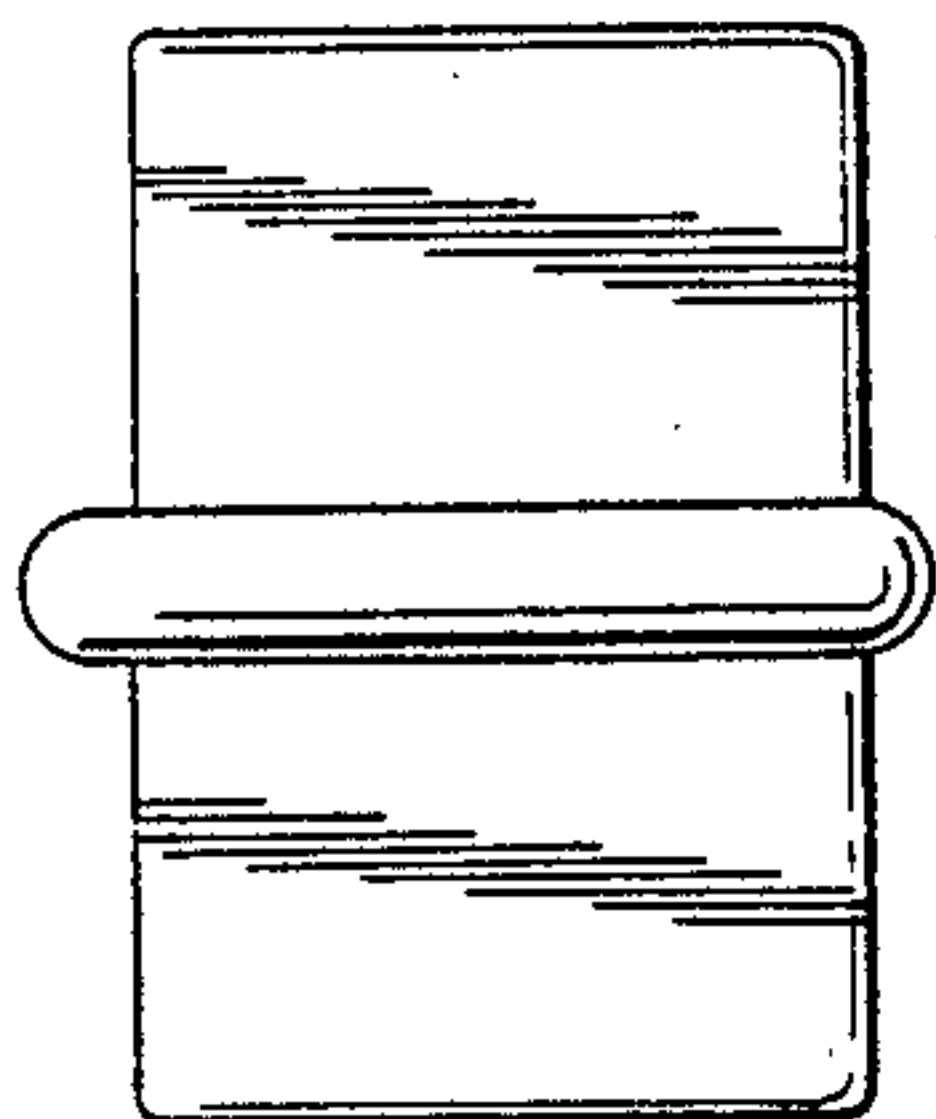

FIG. 5

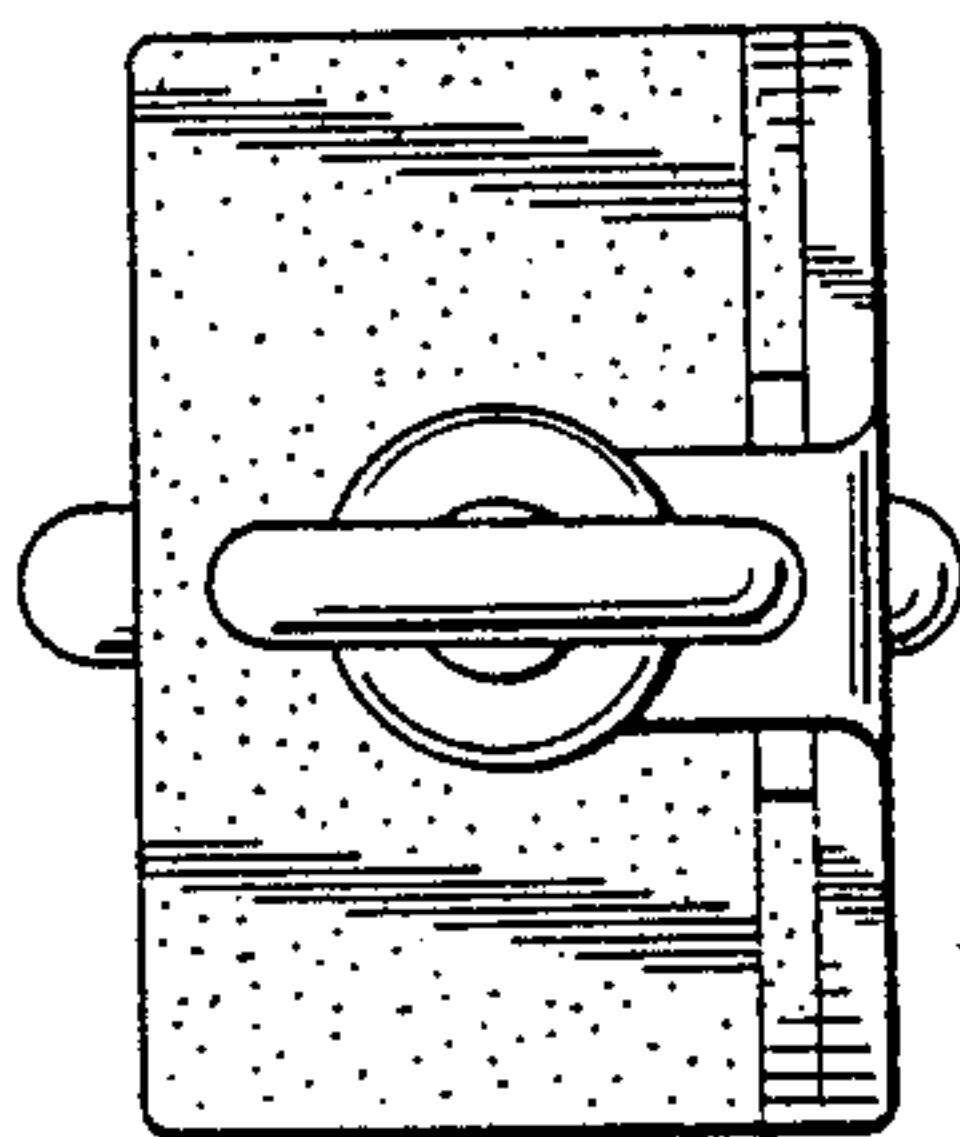

FIG. 6

