

[54] ADJUSTABLE TABLE

[75] Inventor: Manfred Hubert, La Tronche, France

[73] Assignee: Allibert S.A., Grenoble, France

[\*\*] Term: 14 Years

[21] Appl. No.: 12,068

[22] Filed: Feb. 6, 1987

[52] U.S. Cl. .... D6/429; D6/480

[58] Field of Search ..... D6/396, 449, 470, 474, D6/480; 108/111, 153, 157

[56] References Cited

U.S. PATENT DOCUMENTS

- D. 113,215 2/1939 Birkmeyer ..... D6/480
- D. 133,435 8/1942 Gunder ..... D6/470
- D. 169,388 4/1953 Placke ..... D6/474
- D. 225,951 1/1973 Kienel ..... D6/480

OTHER PUBLICATIONS

Interiors, Mar. 1981, p. 11, table in center of page.  
Ekornes, 1983, p. 41, table in center of page.

Primary Examiner—Bruce W. Dunkins  
Assistant Examiner—Schon C. Oppert  
Attorney, Agent, or Firm—Young & Thompson

[57] CLAIM

The ornamental design for an adjustable table, as shown and described.

DESCRIPTION

FIG. 1 is a top perspective view of an adjustable table showing my new design;  
 FIG. 2 is a side perspective view the opposite side view being identical thereto;  
 FIG. 3 is an end elevational view, the opposite end being identical thereto;  
 FIG. 4 is a top plan view thereof; and  
 FIG. 5 is a top perspective view showing the table in an alternate position of use;  
 FIG. 6 is a side perspective view, the opposite side view being identical thereto; and  
 FIG. 7 is an end elevational view, the opposite end being identical thereto.  
 The top plan view of the embodiment of FIGS. 5-7 is identical to FIG. 4.

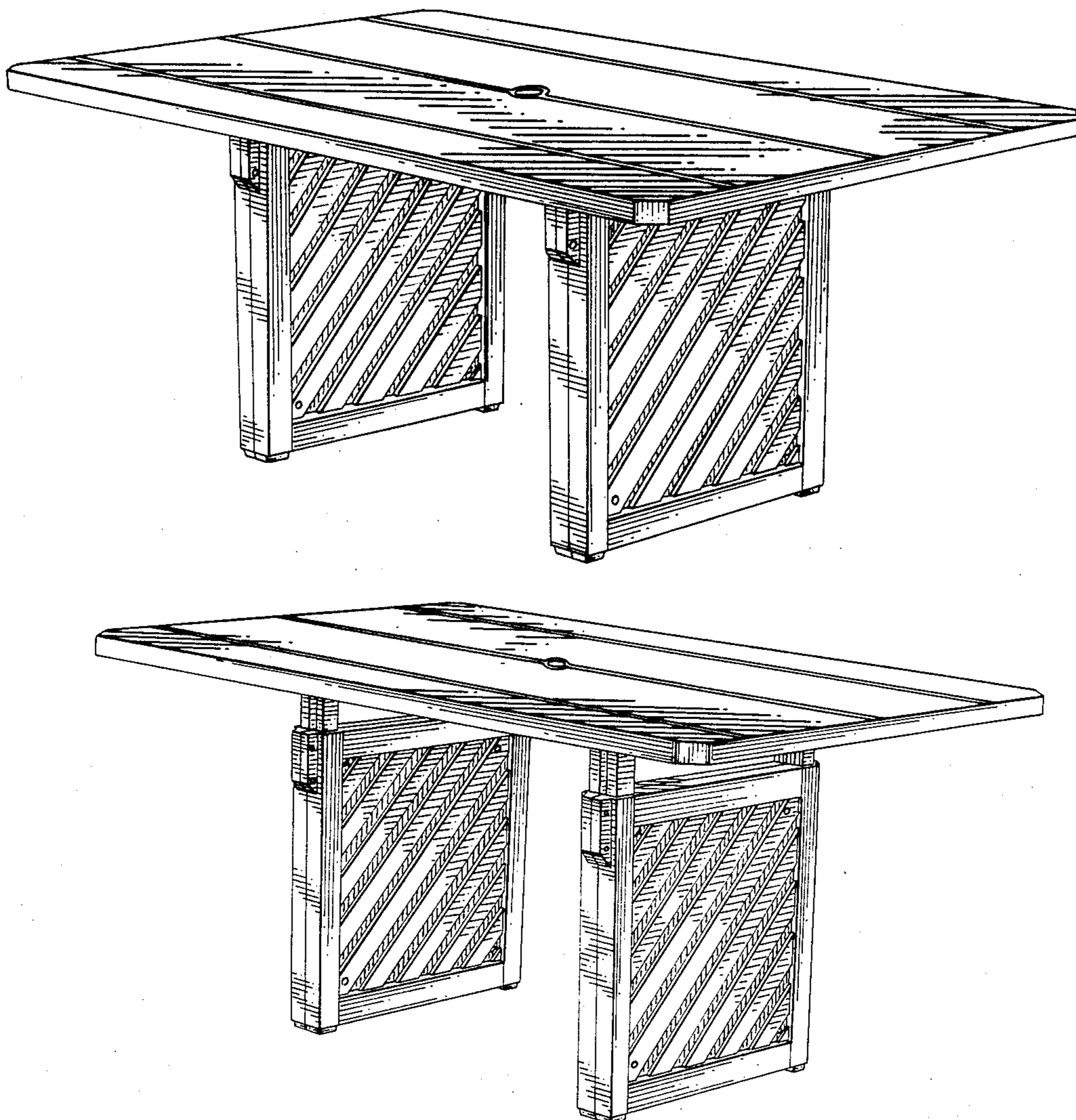

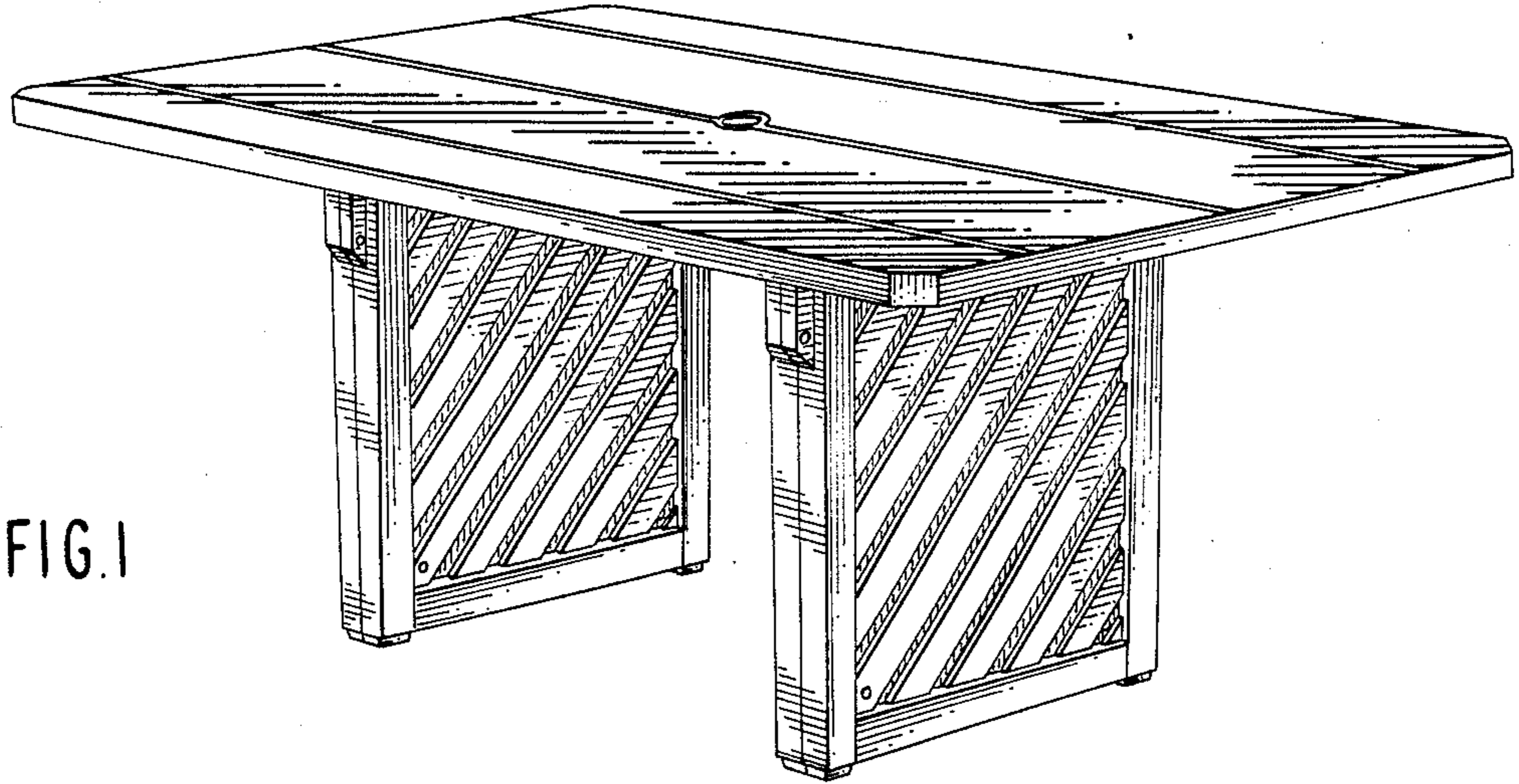

FIG. 1

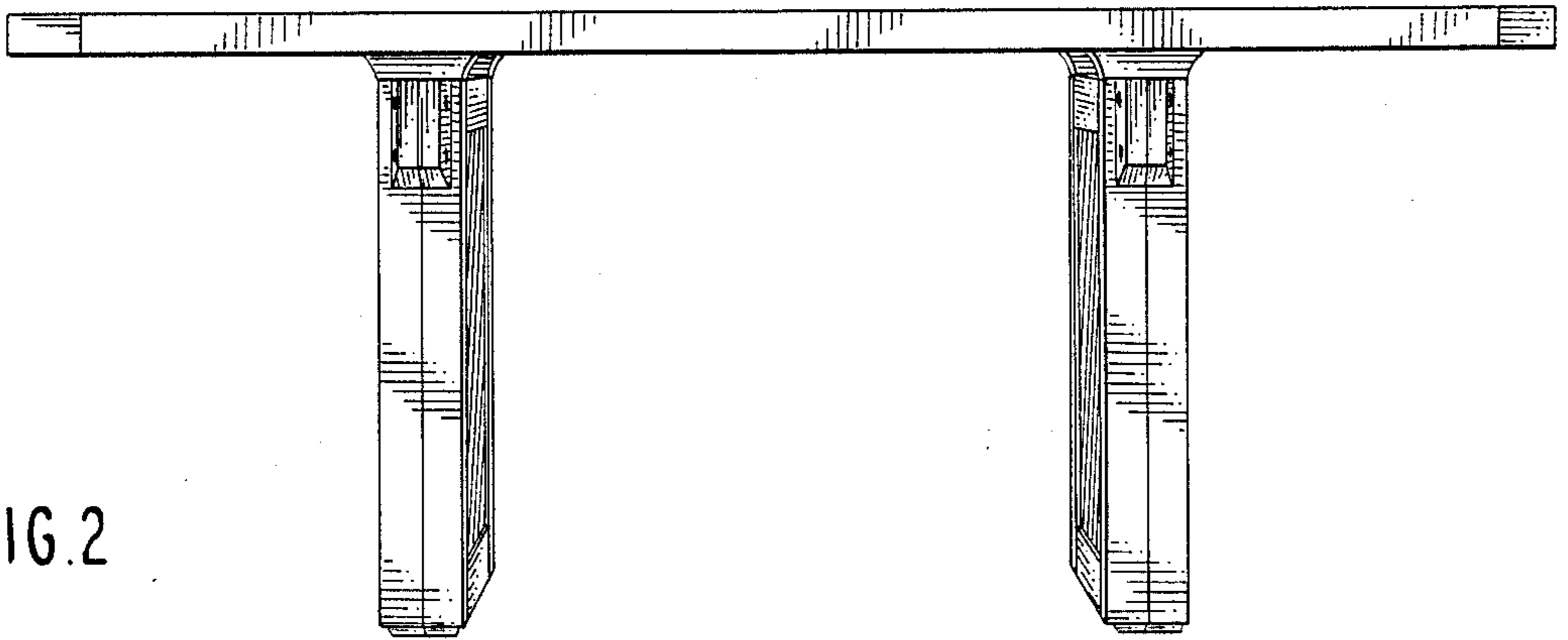

FIG. 2

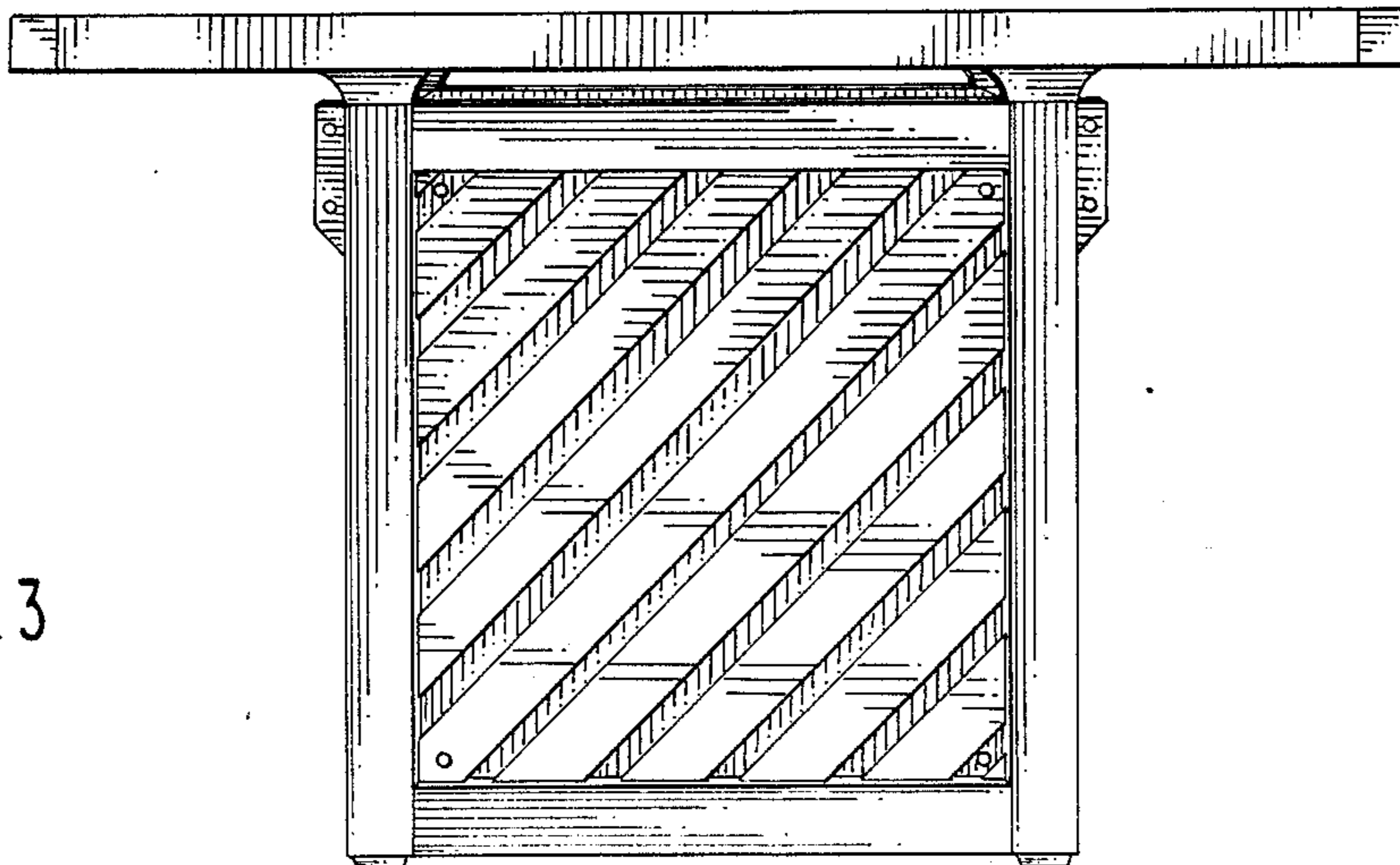

FIG. 3



FIG. 4

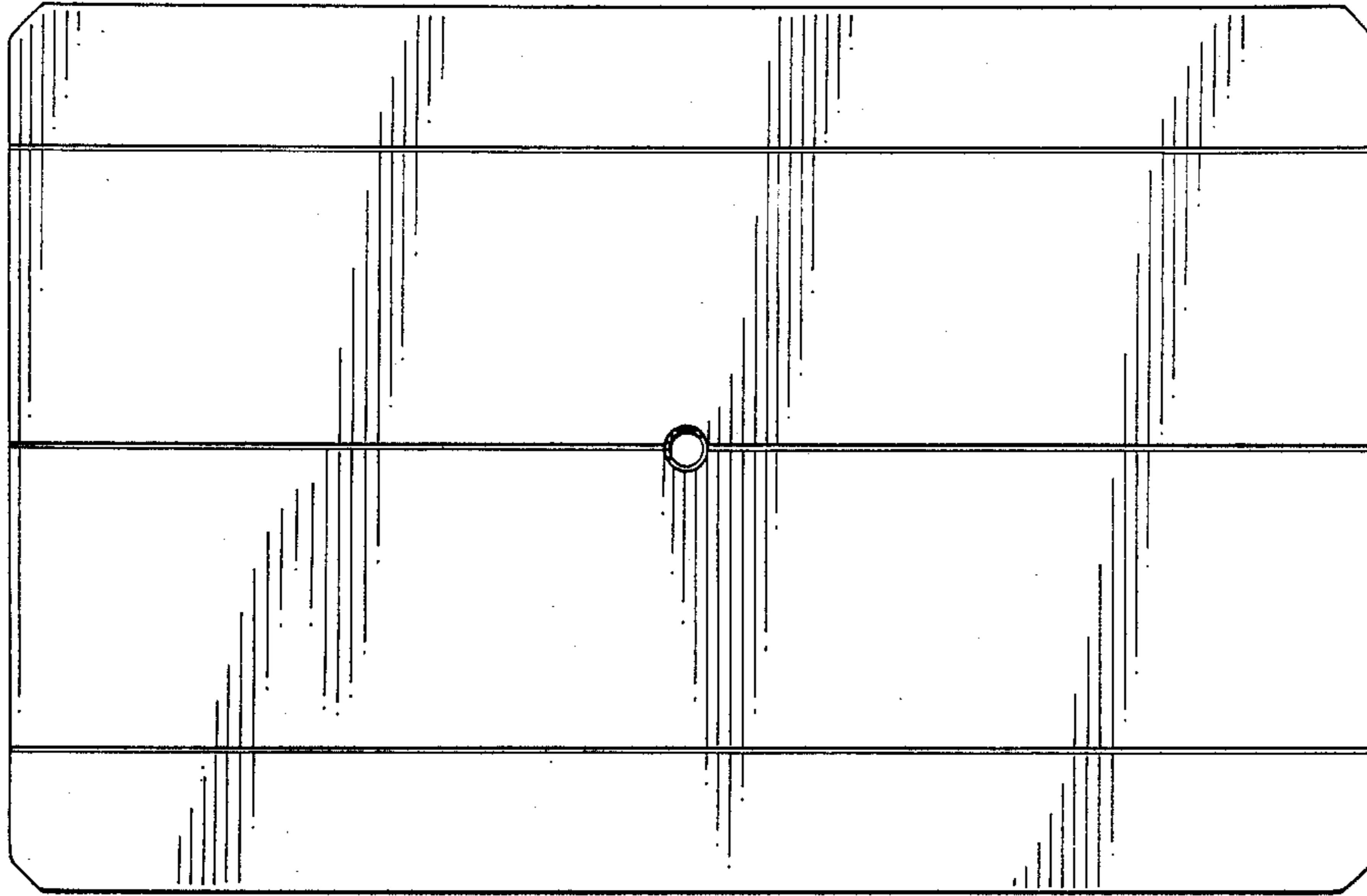

FIG. 5

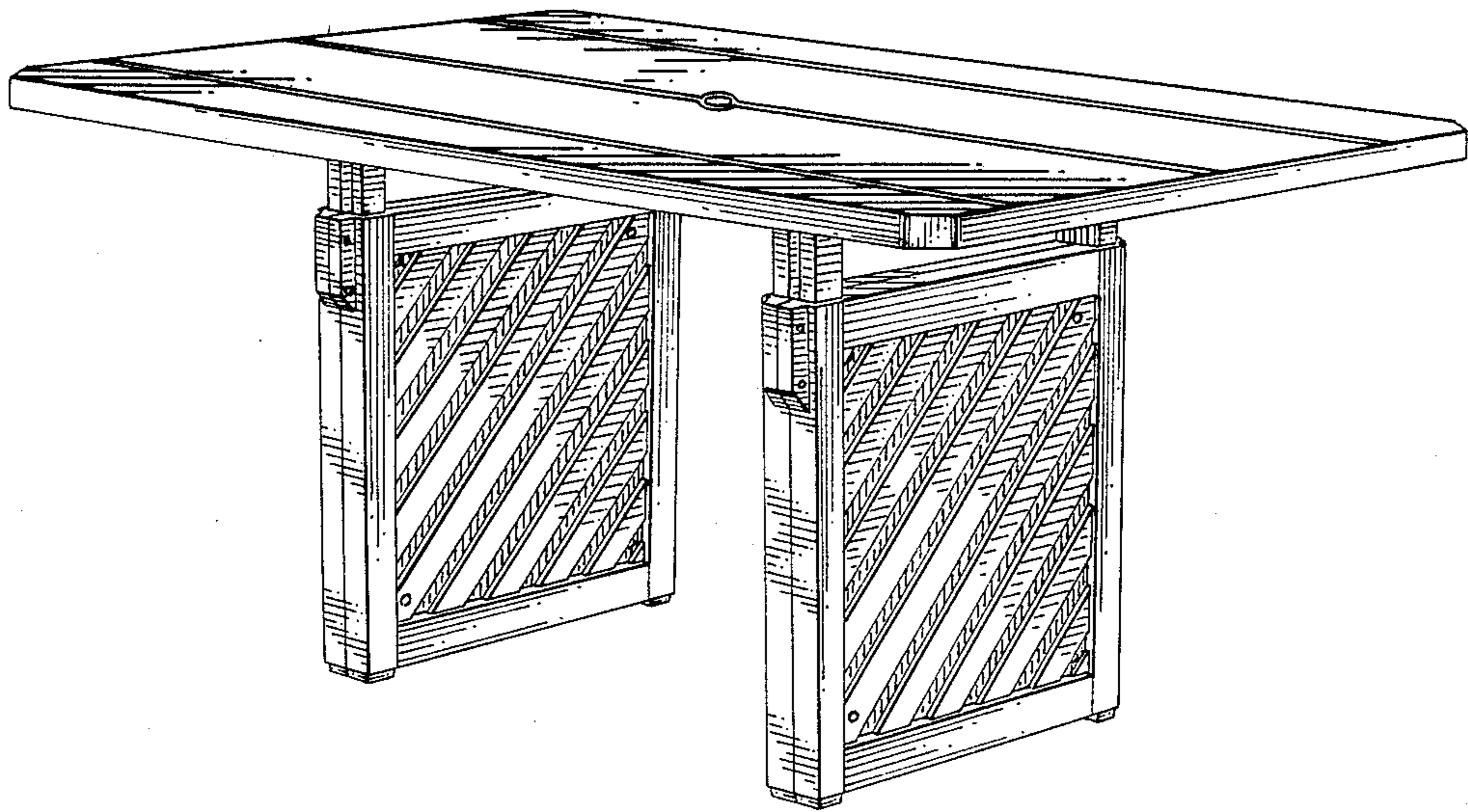

FIG. 6

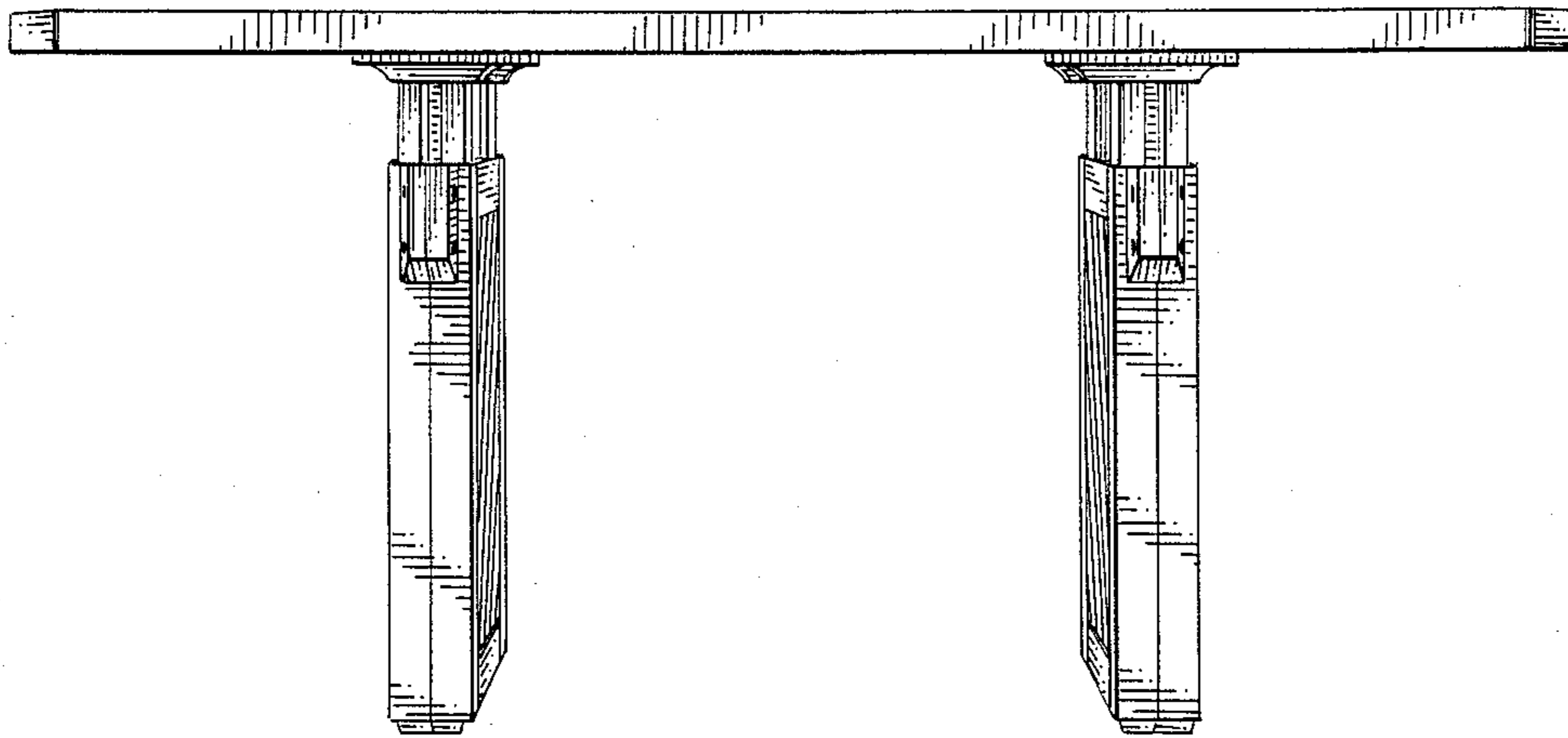

FIG. 7

