

[54] TELEVISION RECEIVER

[75] Inventors: Masaru Shinoda, Tokyo, Japan; Franco Mantegazza, Turin, Italy

[73] Assignee: Kabushiki Kaisha Toshiba, Kawasaki, Japan

[**] Term: 14 Years

[21] Appl. No.: 210,612

[22] Filed: Jun. 21, 1988

[30] Foreign Application Priority Data

Dec. 22, 1987 [JP] Japan 62-52009

[52] U.S. Cl. D14/133

[58] Field of Search D14/125-134, D14/113, 299; 358/254, 255; 312/7.2

[56] References Cited

U.S. PATENT DOCUMENTS

- D. 172,441 6/1954 Portanova D14/133
- D. 176,337 12/1955 Jordon D14/131
- D. 277,854 3/1985 Masuba D14/126
- D. 298,247 10/1988 Kogane et al. D14/126
- D. 298,323 11/1988 Ariyoshi et al. D14/126
- 4,755,881 7/1988 Barlett 358/254

FOREIGN PATENT DOCUMENTS

557742 8/1981 Japan .

OTHER PUBLICATIONS

HFD; 11/3/86; p. 167; Sony 36-inch XBR TV.

Video Review; Apr. 1986; p. 86; bottom left-NEC Digital TV.

Primary Examiner—Bernard Ansher
Assistant Examiner—T. M. Shooman
Attorney, Agent, or Firm—Oblon, Spivak, McClelland, Maier & Neustadt

[57] CLAIM

The ornamental design for a television receiver, as shown and described.

DESCRIPTION

FIG. 1 is a front and right side perspective view of a television receiver showing our new design; FIG. 2 is a front elevational view thereof; FIG. 3 is a top plan view thereof; FIG. 4 is a rear elevational view thereof; FIG. 5 is a left side elevational view thereof; FIG. 6 is a right side elevational view thereof; FIG. 7 is a bottom plan view thereof; FIG. 8 is a cross-sectional view thereof taken on line 8—8' of FIG. 2, with the interior mechanism omitted; FIG. 9 is a front and right side perspective view thereof with the covers shown open; FIG. 10 is a cross-sectional view thereof taken on line 10—10' of FIG. 2, with the interior mechanism omitted; FIG. 11 is a cross-sectional view thereof taken on line 11—11' of FIG. 2, with the interior mechanism omitted; and FIG. 12 is a cross-sectional view thereof taken on line 12—12' of FIG. 2, with the interior mechanism omitted.

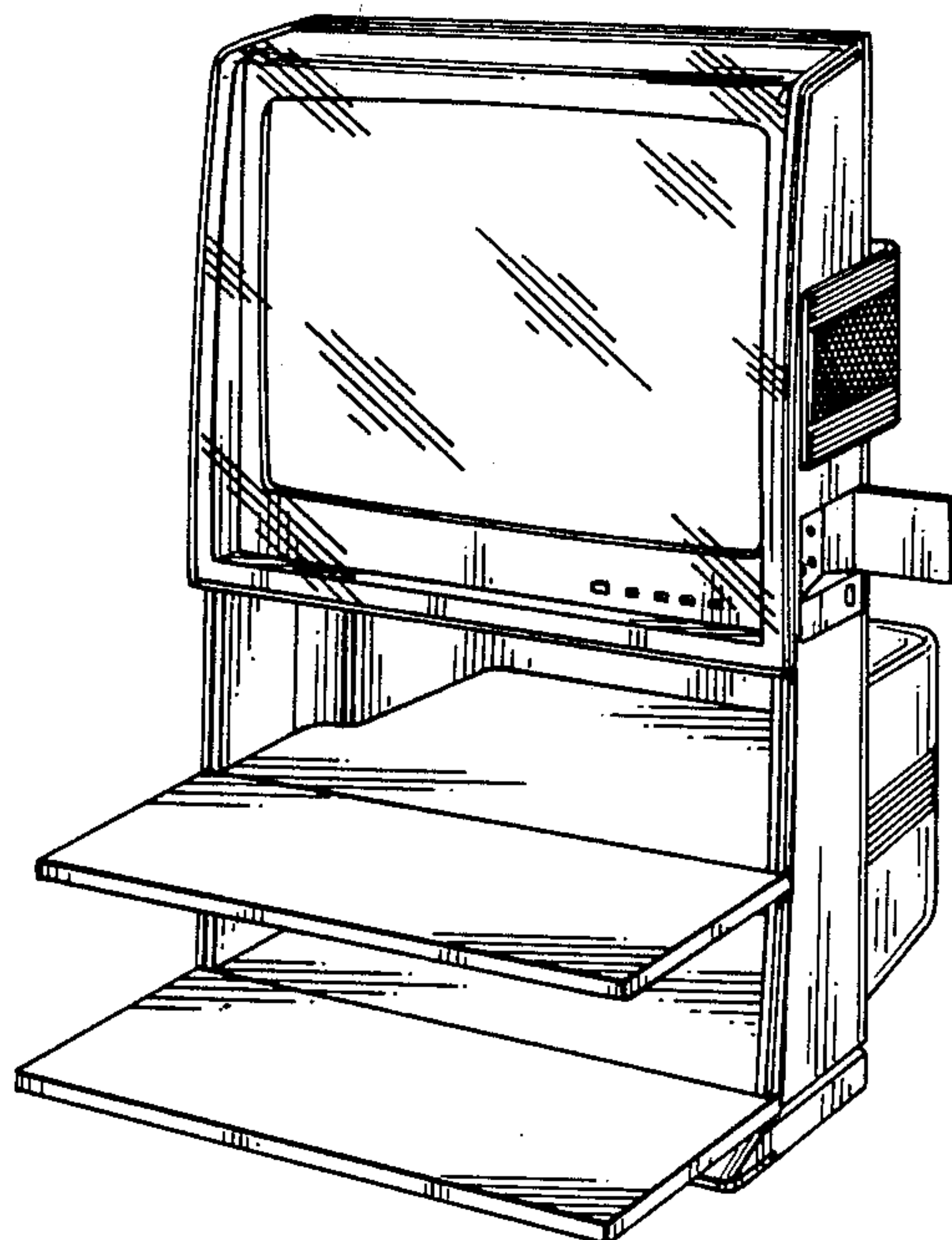
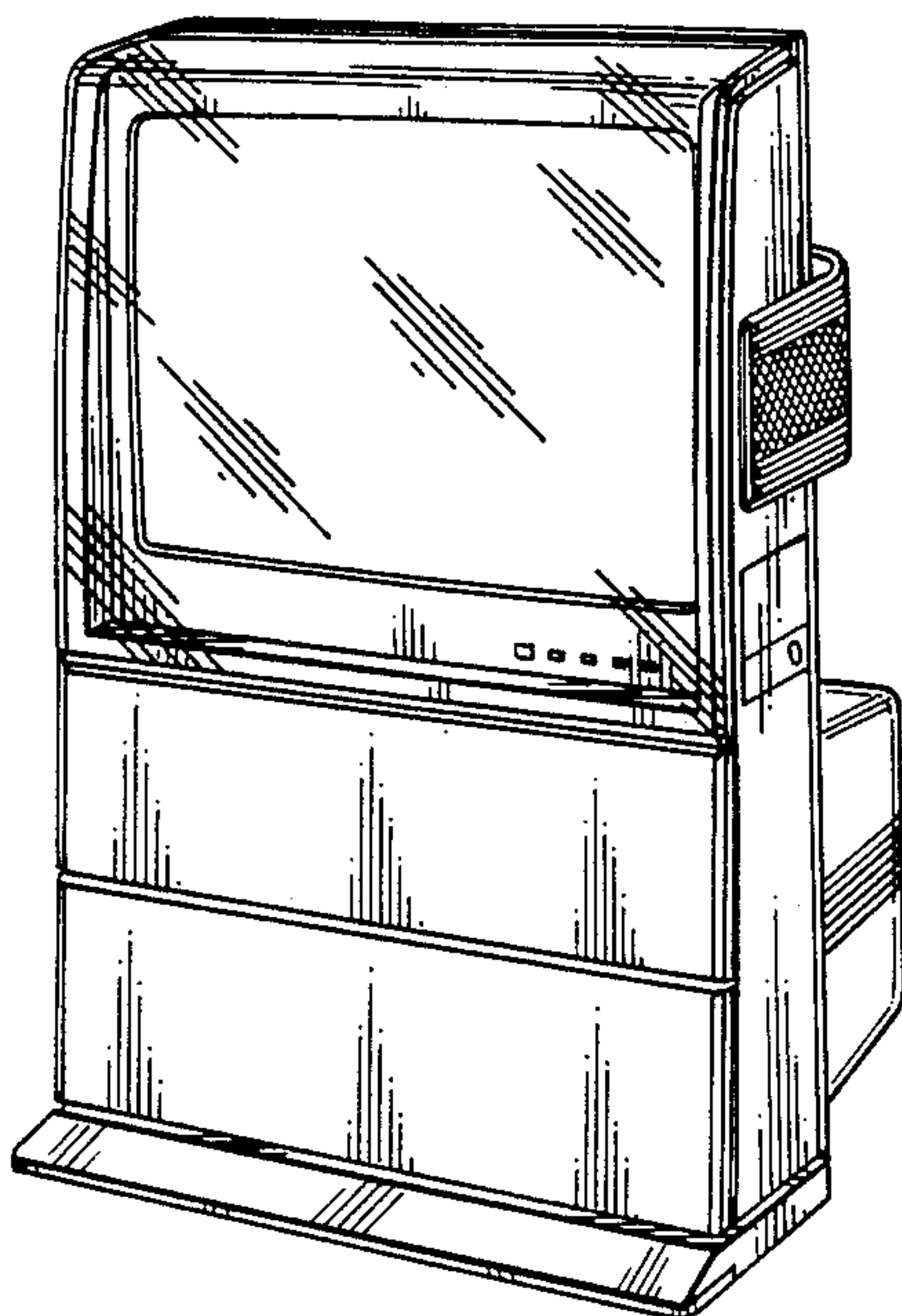

FIG. 1

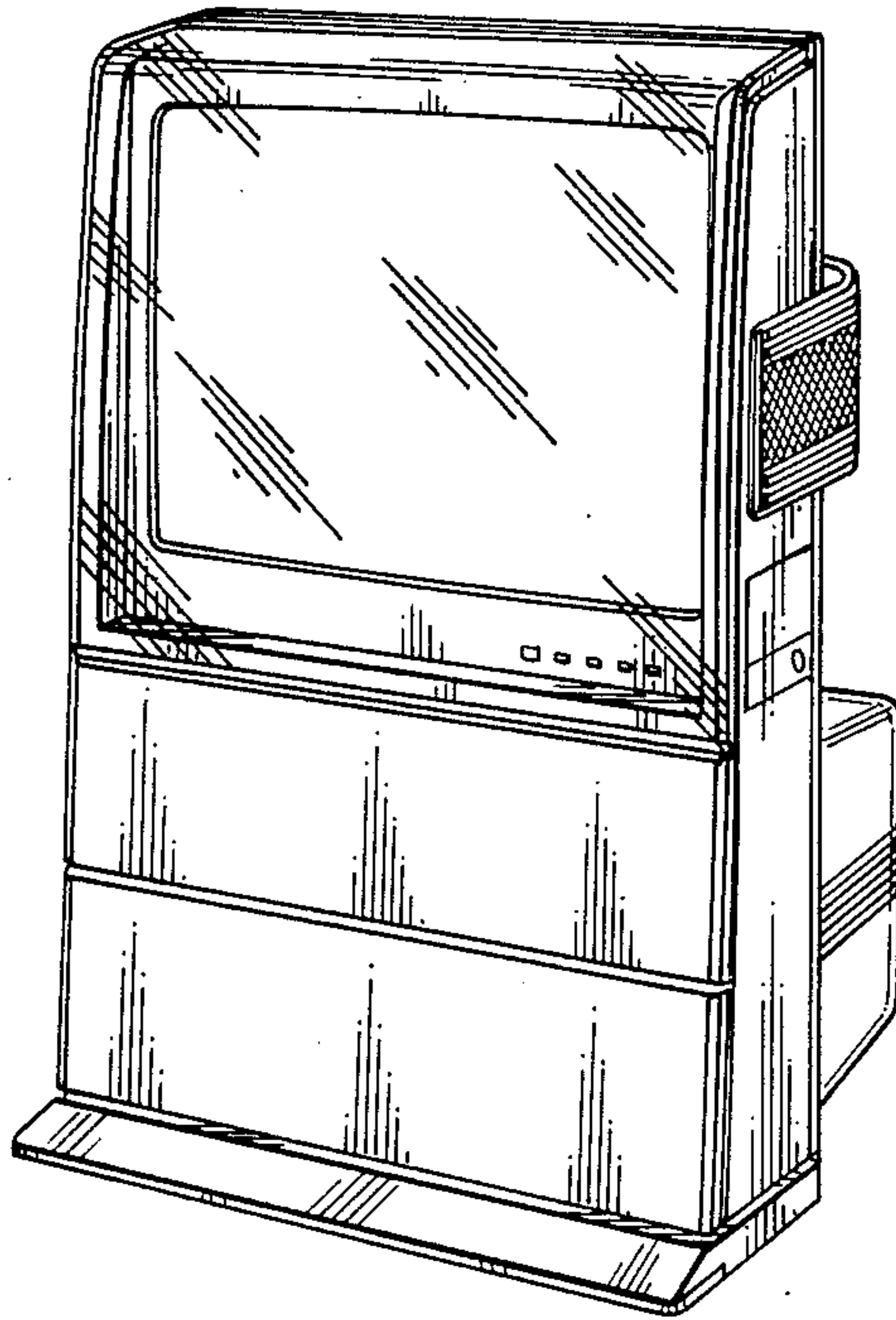

FIG. 2

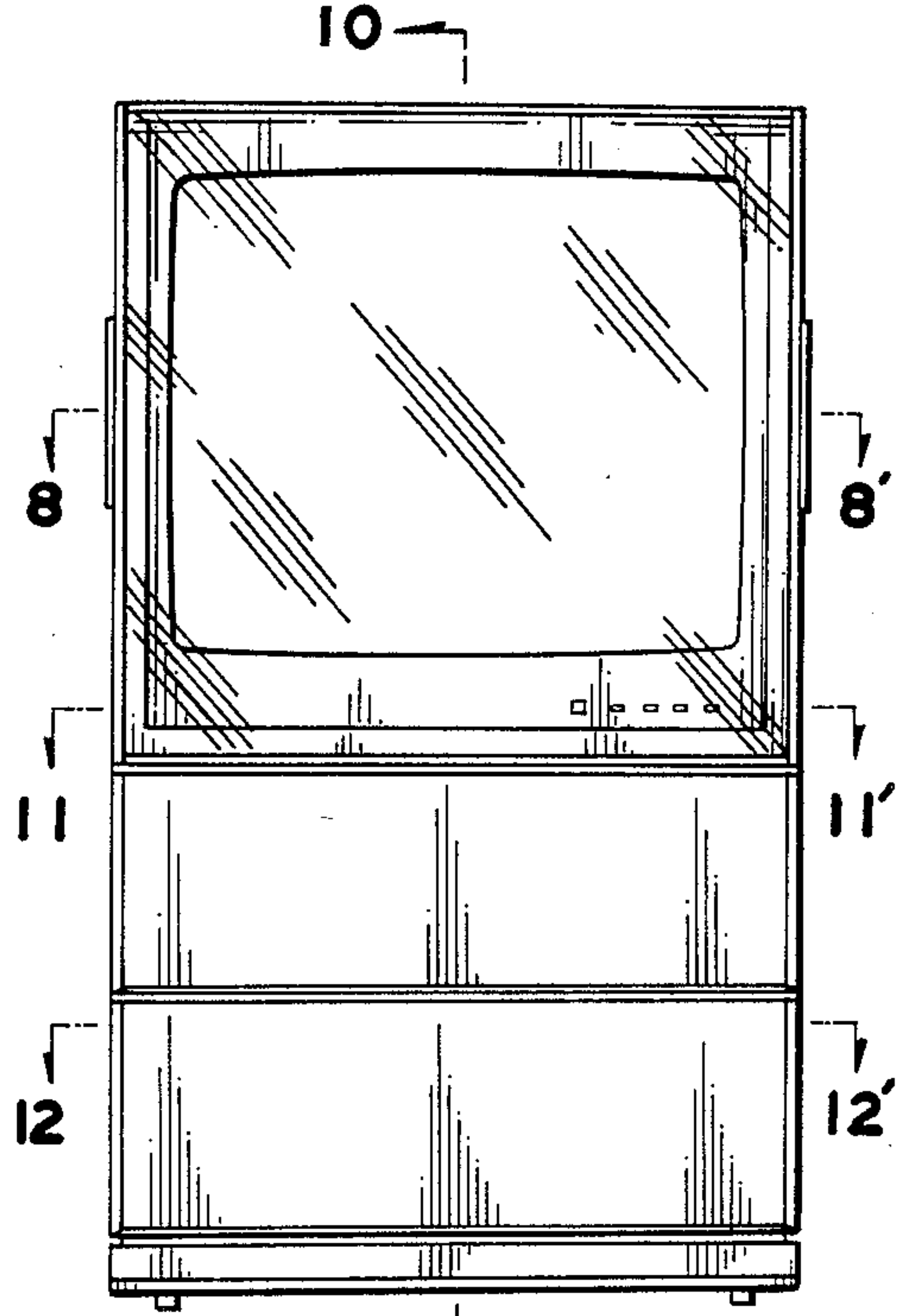

FIG. 4

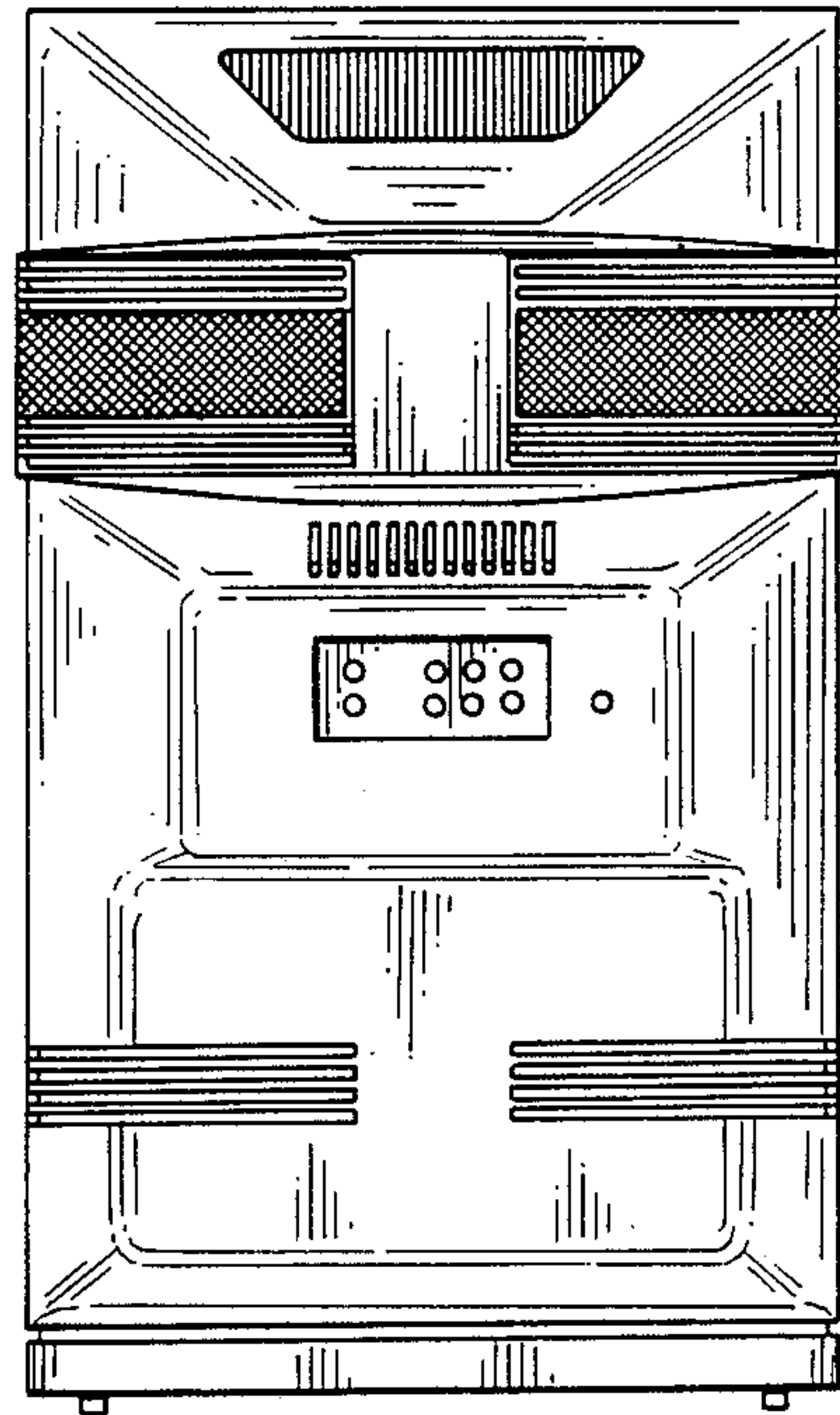

FIG. 3

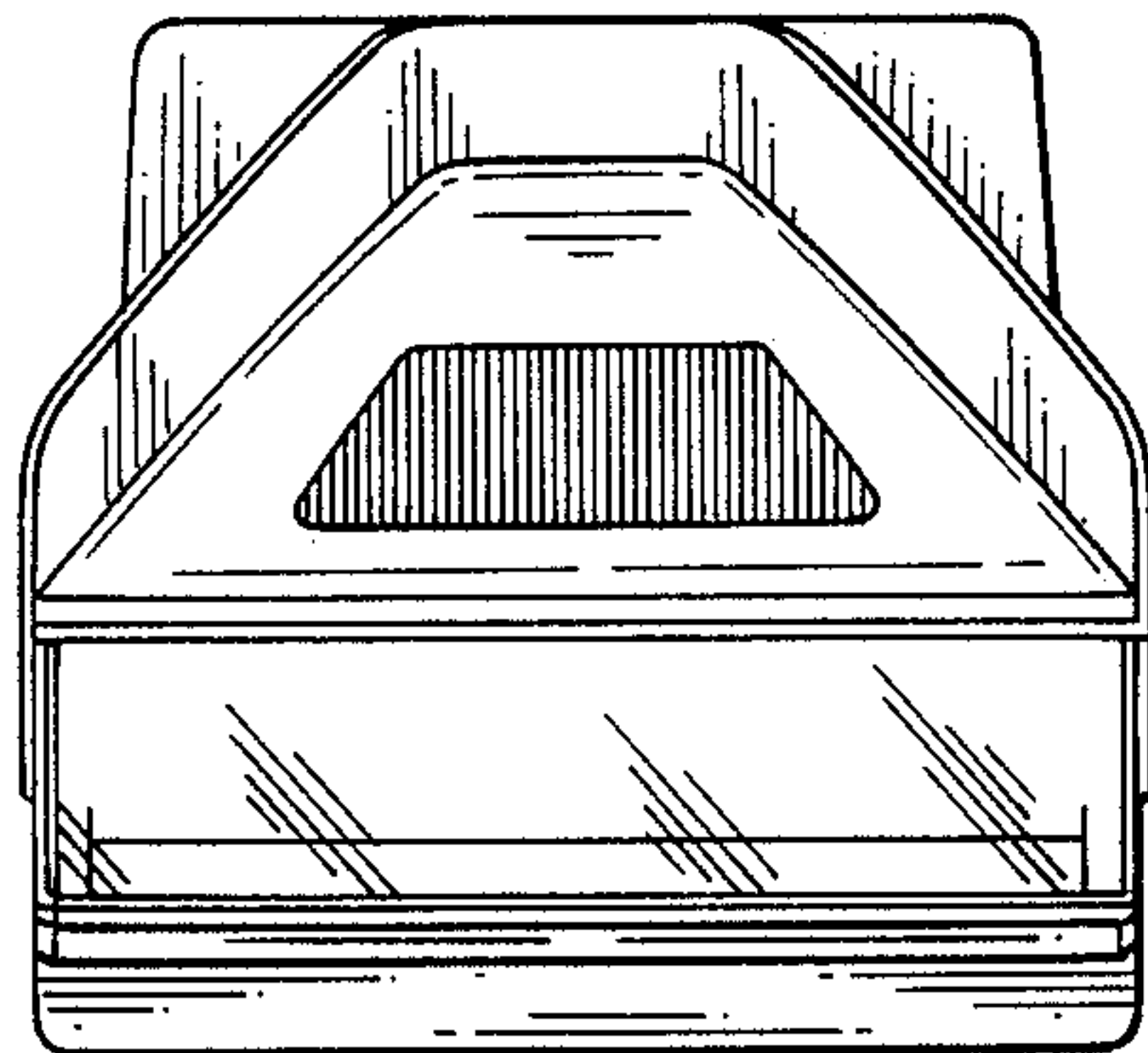

FIG. 5

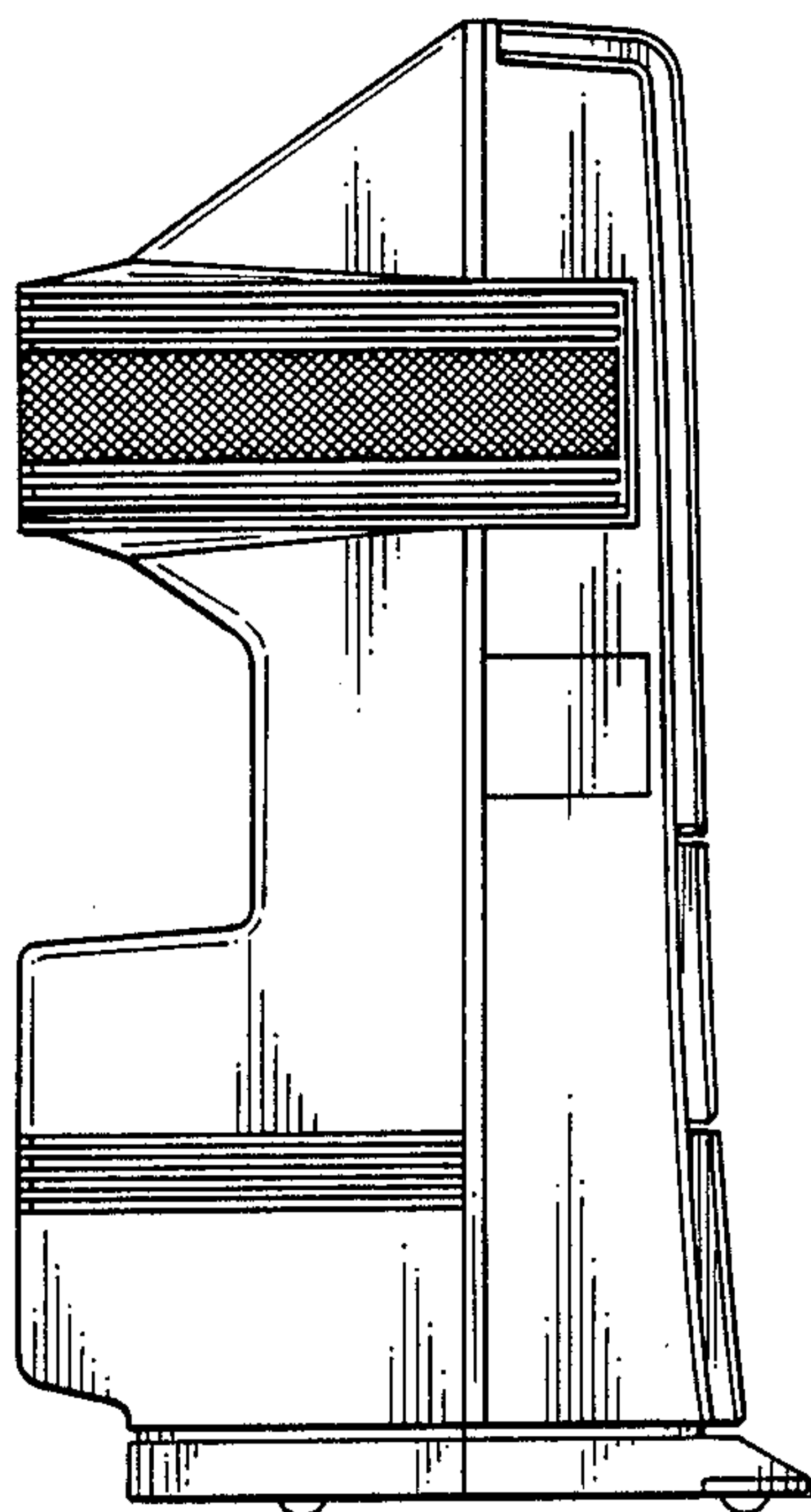

FIG. 6

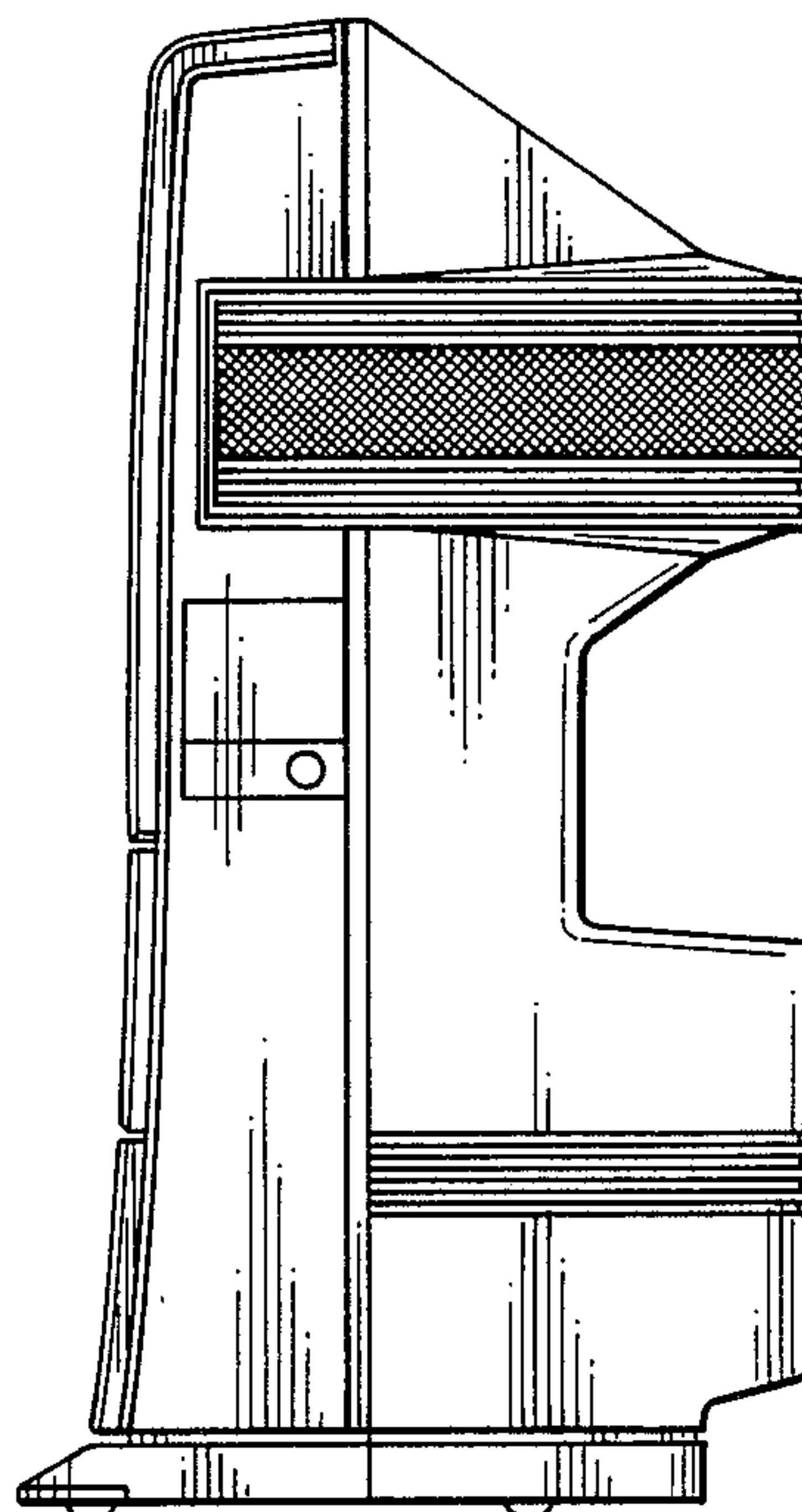

FIG. 7

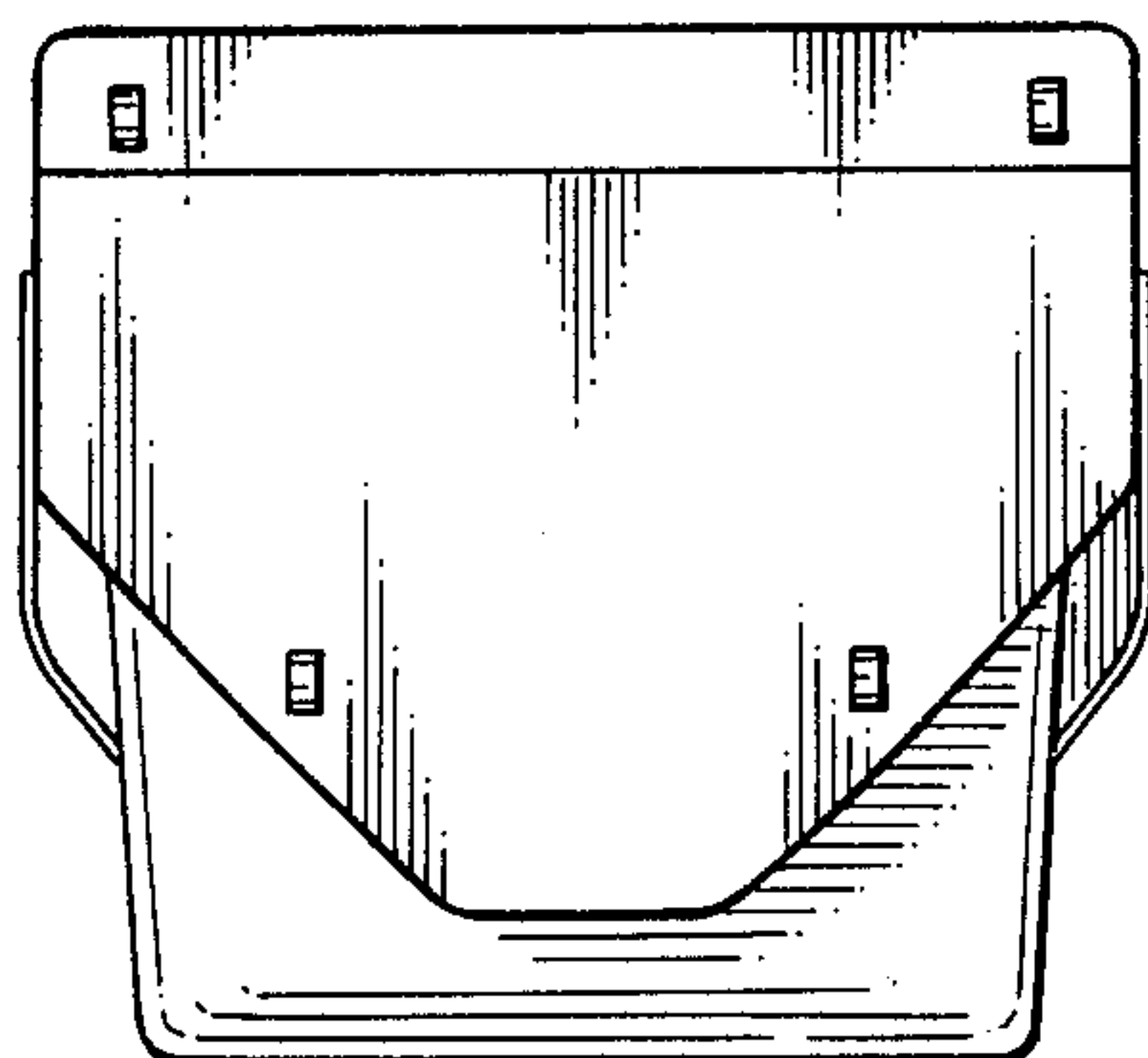

FIG. 8

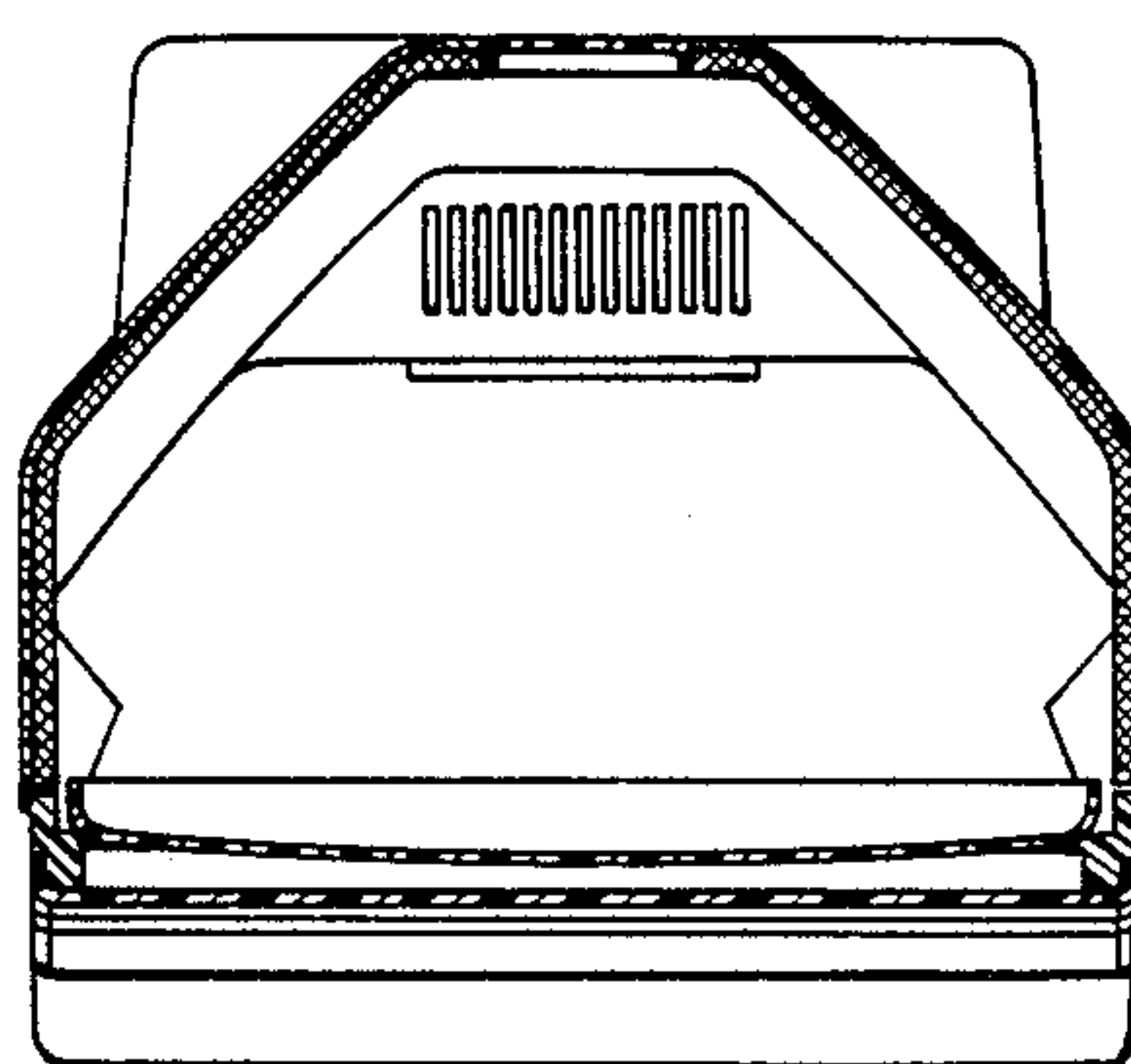

FIG. 9

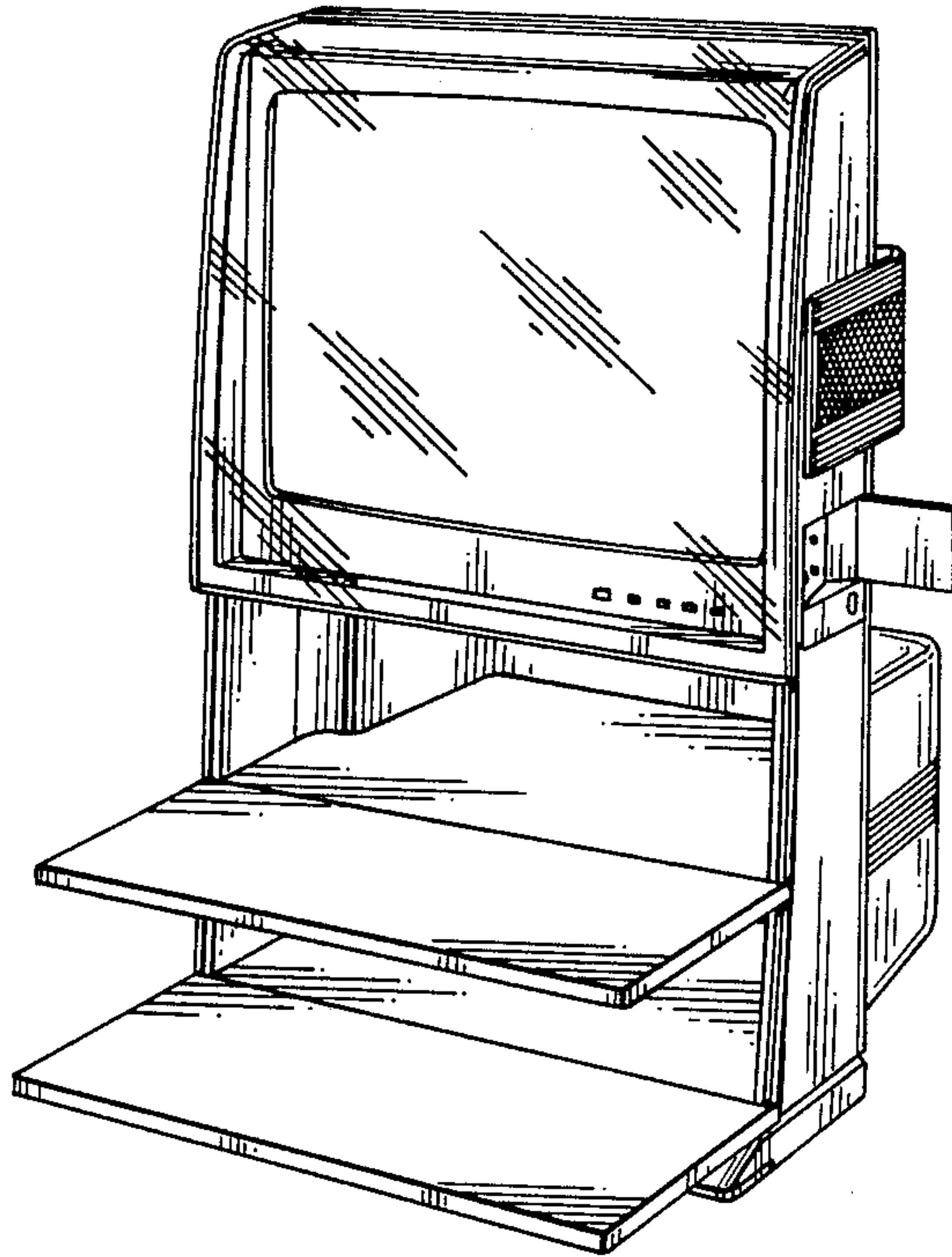

FIG. 10

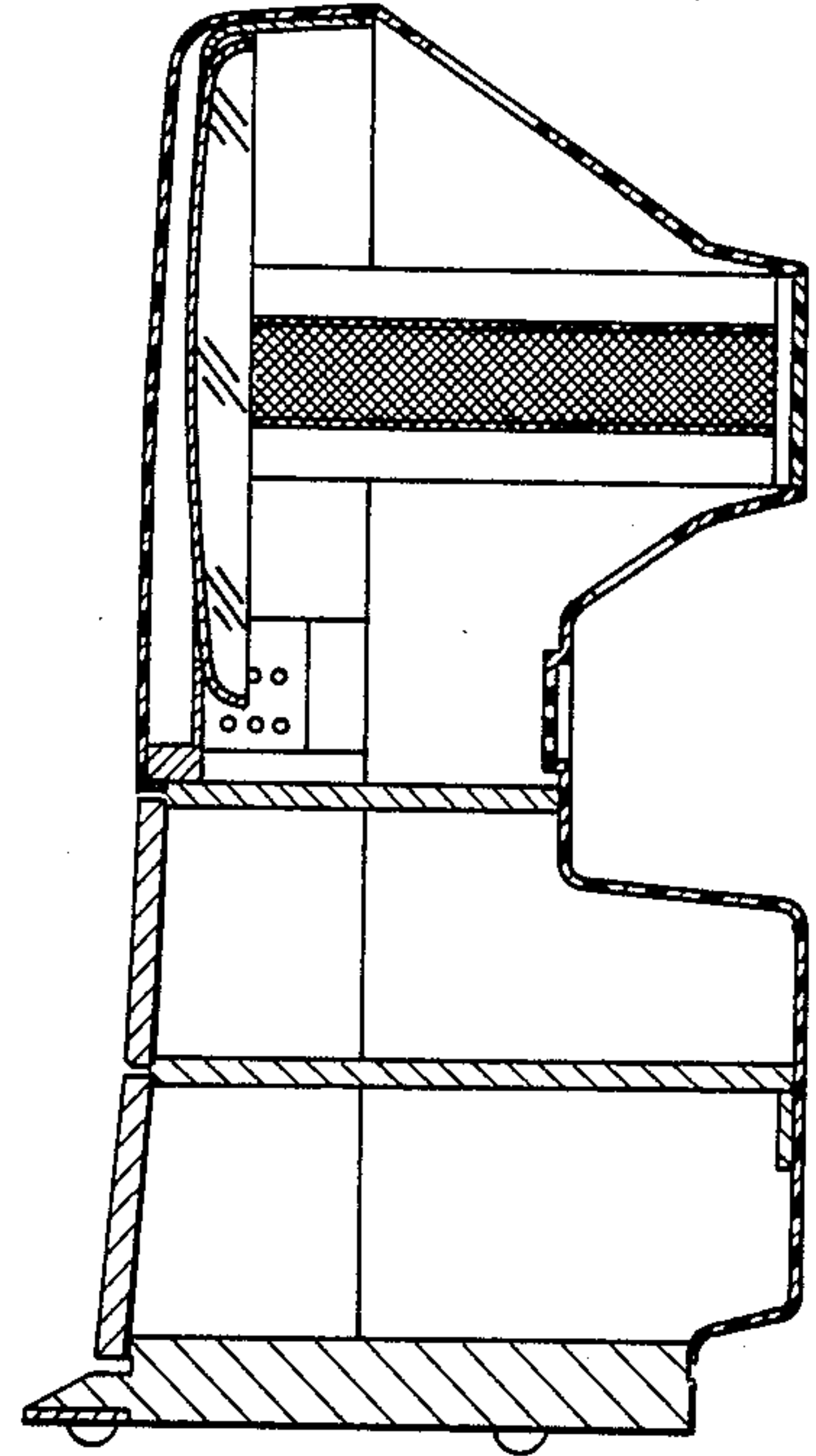

FIG. 11

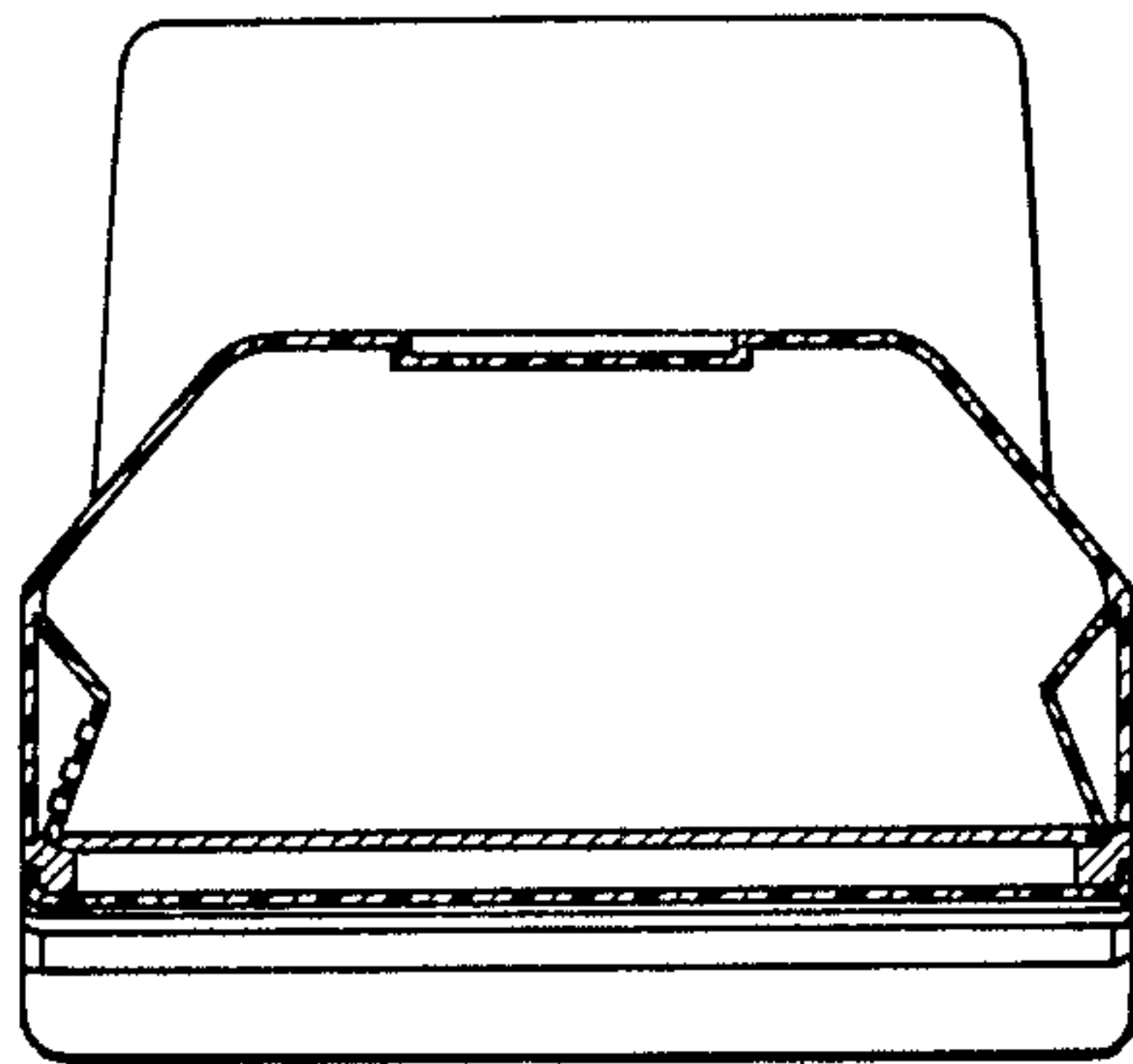

FIG. 12

