

[54] **TELEVISION RECEIVER**

[75] **Inventor: Tatsuyuki Mikami, Ichikawa, Japan**

[73] **Assignee: Kabushiki Kaisha Toshiba, Kawasaki, Japan**

[**] **Term: 14 Years**

[21] **Appl. No.: 284,486**

[22] **Filed: Dec. 15, 1988**

[30] **Foreign Application Priority Data**

Jun. 17, 1988 [JP] Japan 63-23856
[52] **U.S. Cl. D14/126**
[58] **Field of Search D14/125-134, D14/113, 299; 358/254, 255; 312/7.2**

[56] **References Cited**

U.S. PATENT DOCUMENTS

- D. 277,854 3/1985 Masuba D14/126
- D. 289,161 4/1987 Aoki et al. D14/133
- D. 297,010 8/1988 Takahashi et al. D14/126
- D. 298,247 10/1988 Kogane et al. D14/126

FOREIGN PATENT DOCUMENTS

685595 8/1986 Japan .

OTHER PUBLICATIONS

Video Review; Jul. 1987; p. 62; bottom left—Sharp TV.
Video Review; Nov. 1987; p. 66; Proton's Super Set.
Video Review; Dec. 1987; p. 55; bottom left—Mitsubishi model VS-683R.

Primary Examiner—Bernard Ansher
Assistant Examiner—Theodore M. Shooman
Attorney, Agent, or Firm—Oblon, Spivak, McClelland, Maier & Neustadt

[57] **CLAIM**

The ornamental design for a television receiver, as shown.

DESCRIPTION

FIG. 1 is a front perspective view of a television receiver showing my new design;
FIG. 2 is a front elevational view thereof;
FIG. 3 is a right side elevational view thereof;
FIG. 4 is a left side elevational view thereof;
FIG. 5 is a top plan view thereof;
FIG. 6 is a rear elevational view thereof; and
FIG. 7 is a bottom plan view thereof.

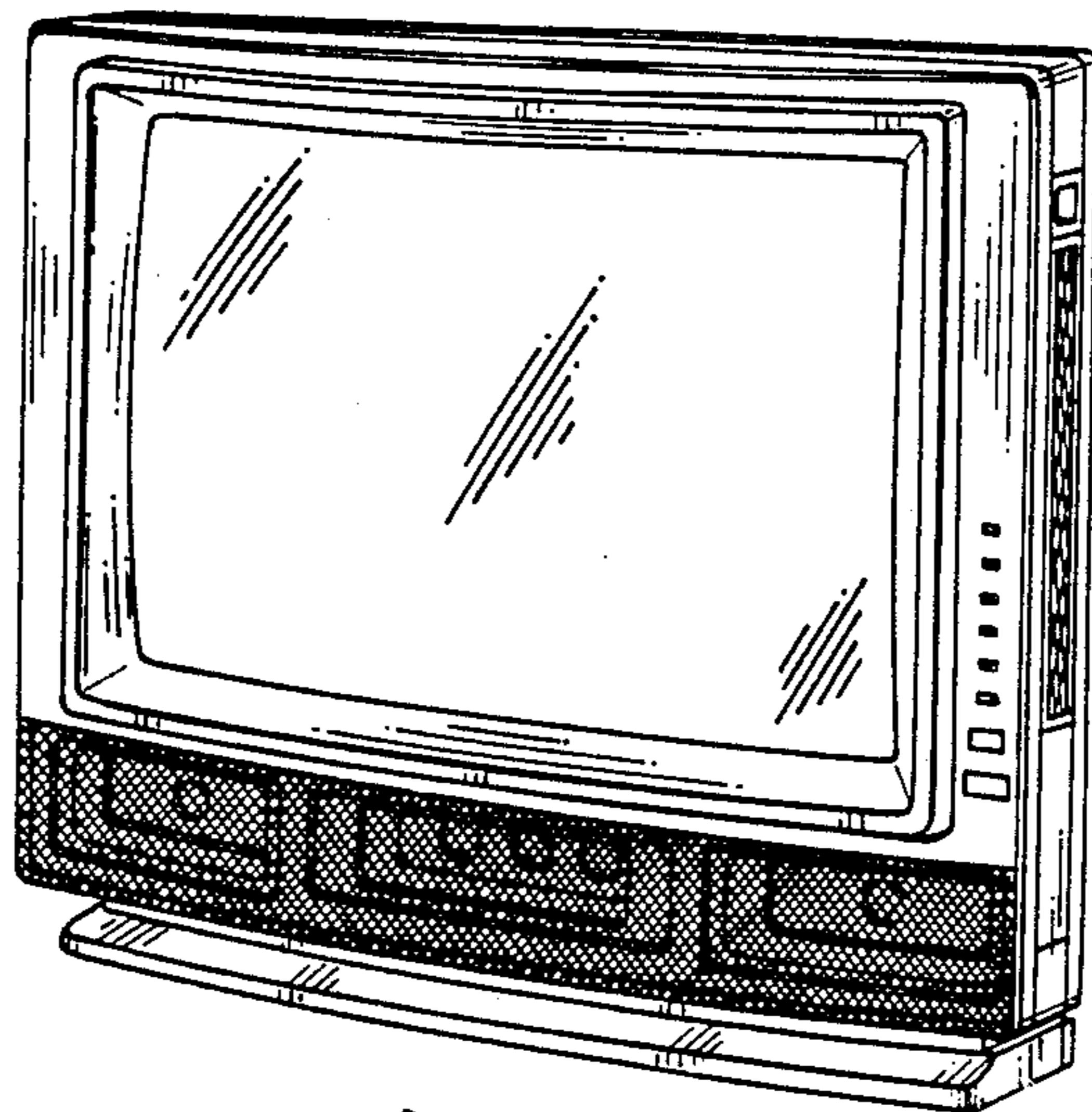

FIG. 1

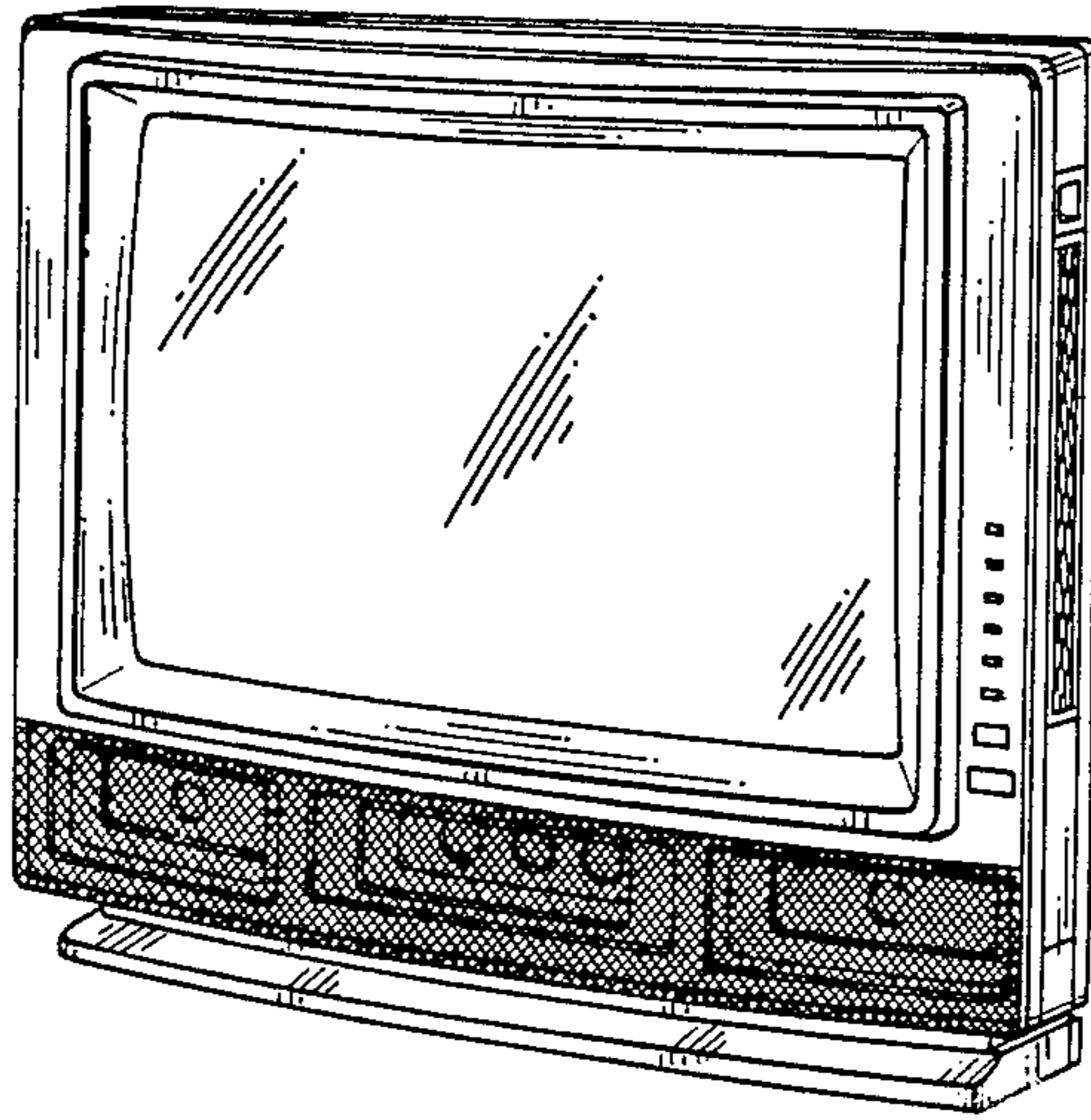

FIG. 2

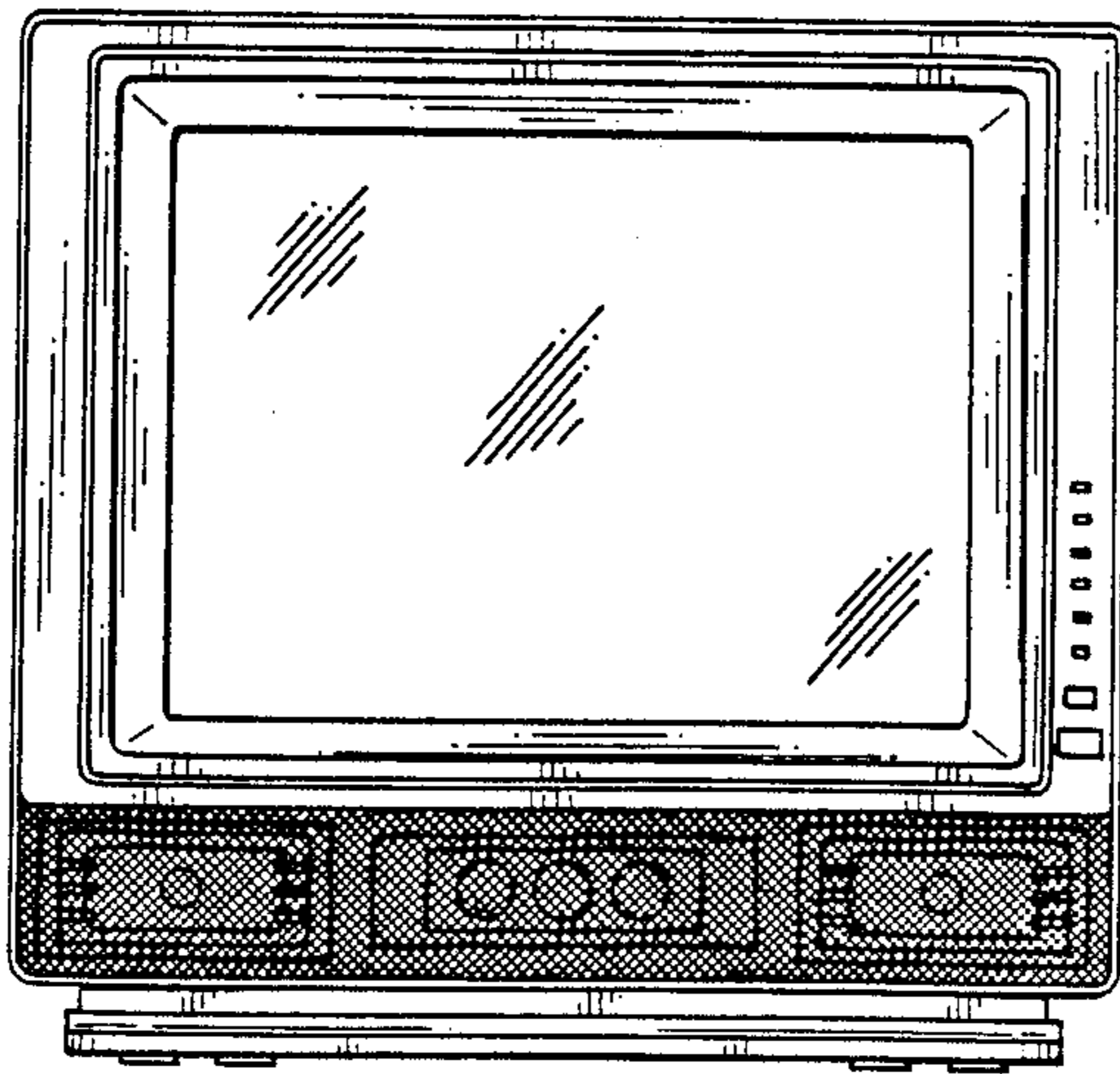

FIG. 3

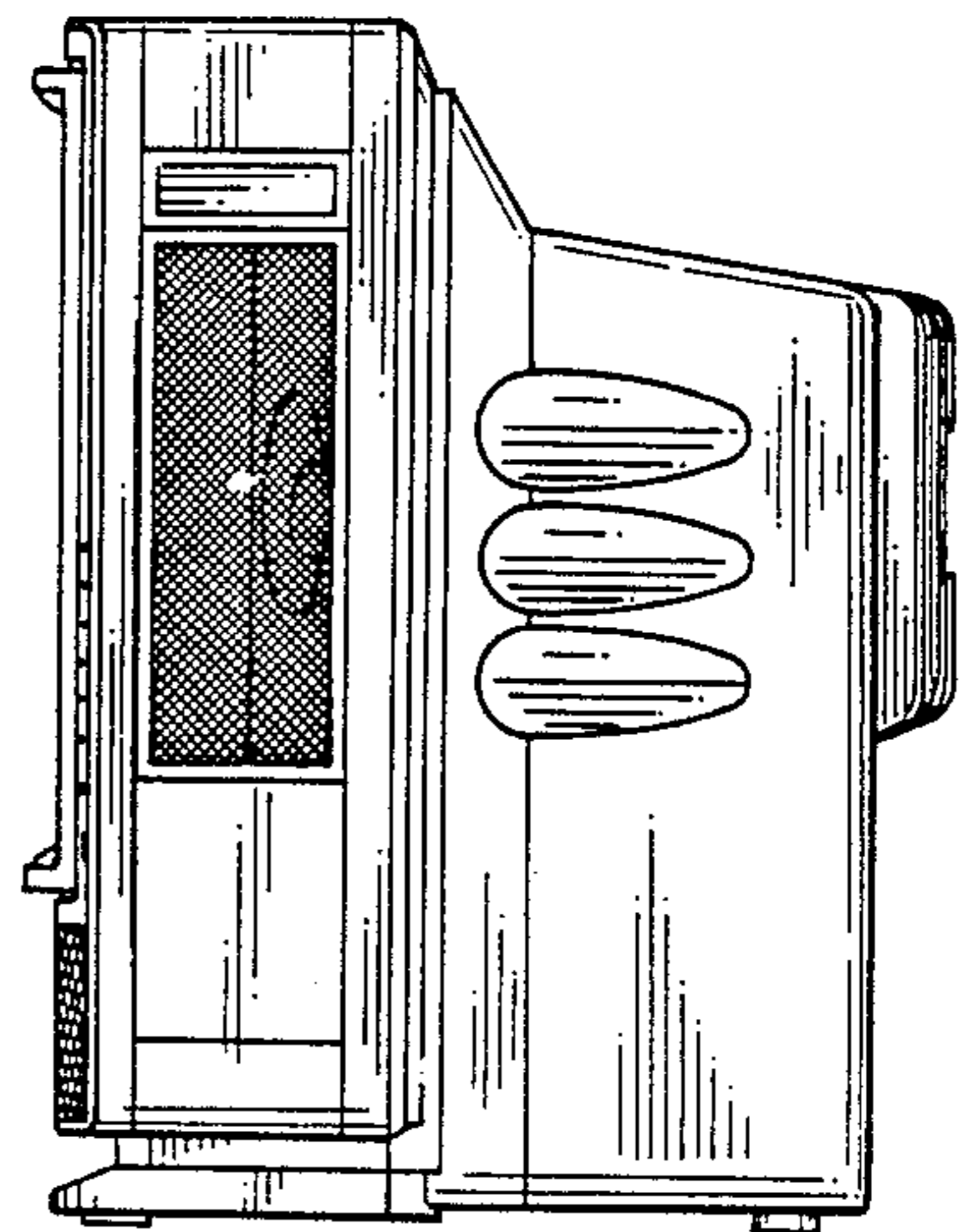

FIG. 4

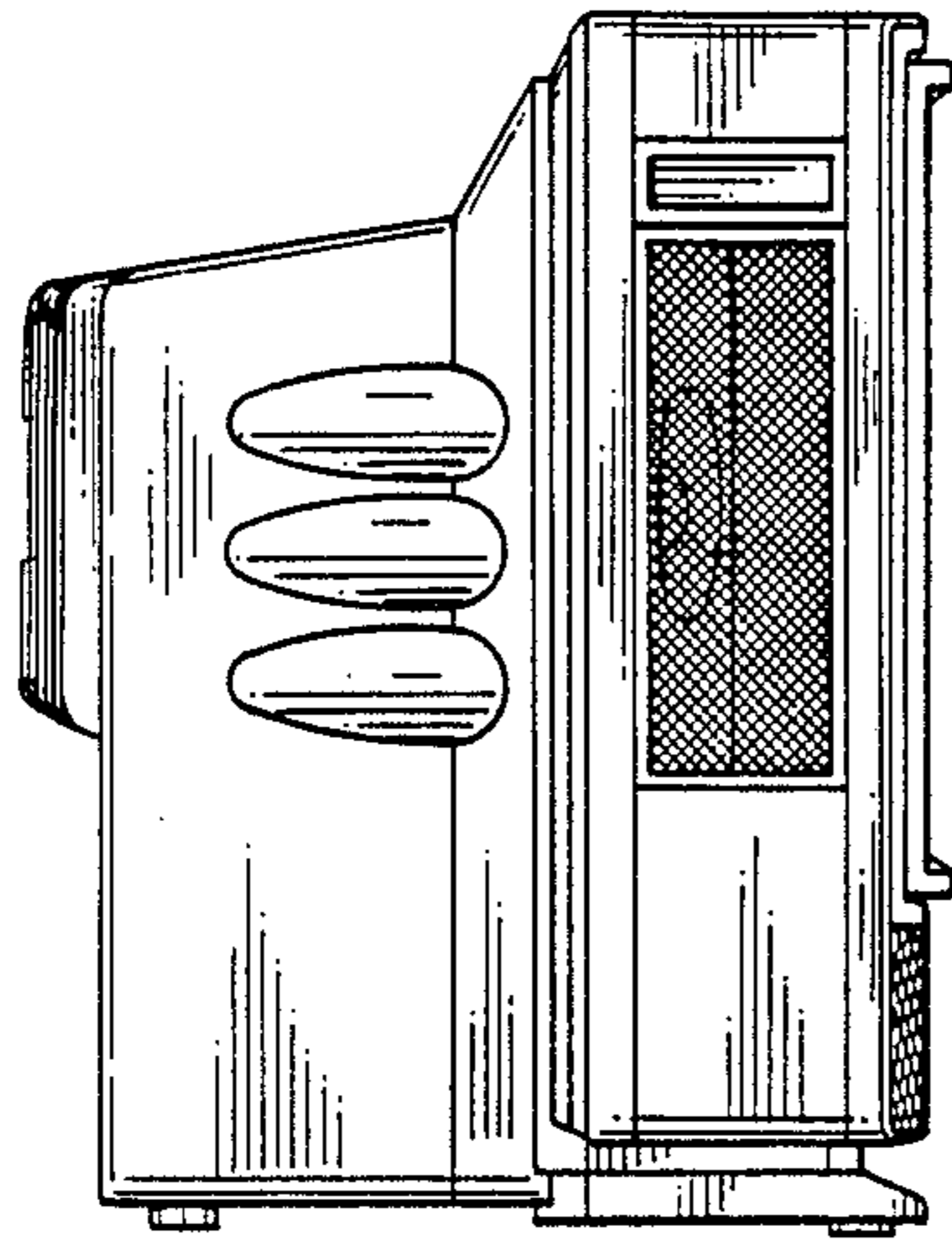

FIG. 5

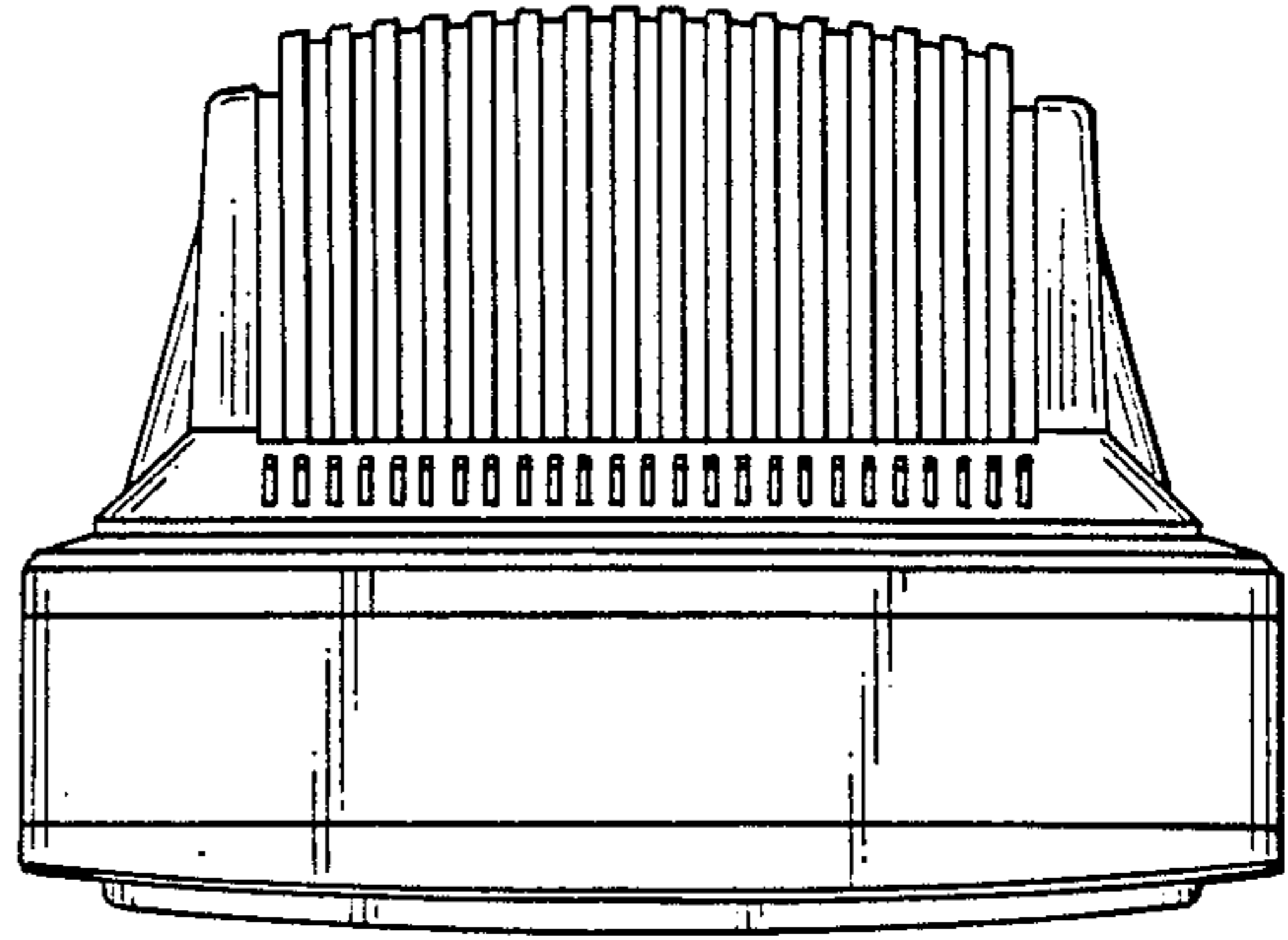

FIG. 6

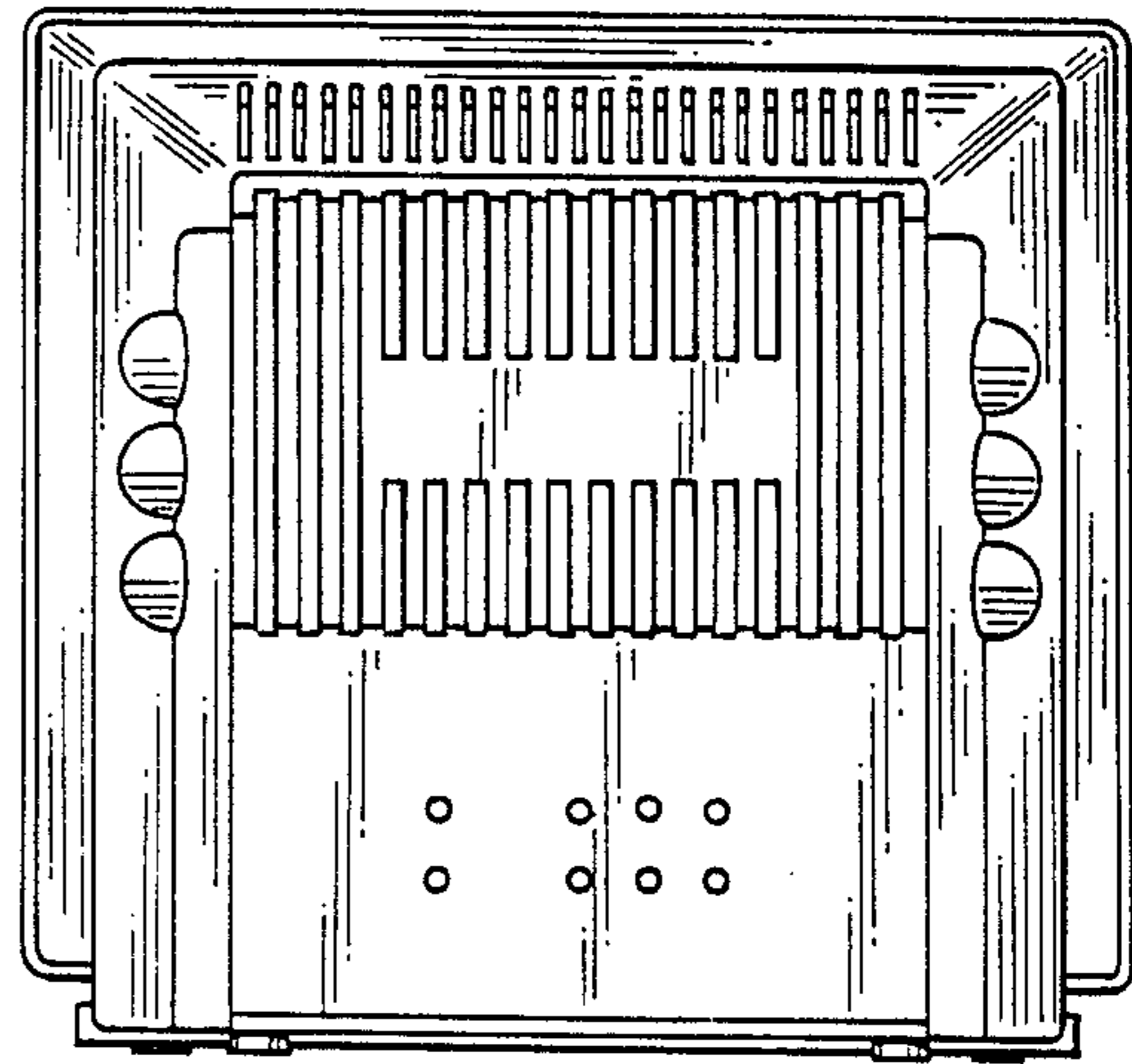

FIG. 7

