

United States Patent [19]

Hammerö

[11] Patent Number: Des. 308,357

[45] Date of Patent: ** Jun. 5, 1990

[54] HOUSE BOAT

[75] Inventor: Lars Hammerö, Viken, Sweden

[73] Assignee: Turinova Aktiebolag, Uppsala, Sweden

[**] Term: 14 Years

[21] Appl. No.: 277,222

[22] Filed: Nov. 29, 1988

[30] Foreign Application Priority Data

May 30, 1988 [SE] Sweden 881322

[52] U.S. Cl. D12/315; D12/318; D25/18; D25/11

[58] Field of Search D12/315, 318; 114/71, 114/60, 344; D215/18, 11

[56] References Cited

U.S. PATENT DOCUMENTS

D. 130,582 12/1941 Kaufmann D25/18

D. 192,197 2/1962 Luger D12/315

D. 217,512 5/1970 Schwartz D12/315

D. 220,945 6/1971 Hughes D25/18

D. 256,113 7/1980 Fortier D12/318

D. 265,646 8/1982 Fortier D12/315

4,064,584 12/1977 Funkhauser D12/318

Primary Examiner—Wallace R. Burke

Assistant Examiner—Kay H. Chin

Attorney, Agent, or Firm—Brooks & Kushman

[57] CLAIM

The ornamental design for a house boat, as shown and described.

DESCRIPTION

FIG. 1 is a right side elevational view of a house boat showing my new design;

FIG. 2 is a left side elevational view thereof;

FIG. 3 is an enlarged rear elevational view thereof;

FIG. 4 is an enlarged front elevational view thereof;

FIG. 5 is a top plan view thereof;

FIG. 6 is a bottom plan view thereof;

FIG. 7 is a front perspective view thereof; and

FIG. 8 is a rear perspective view thereof.

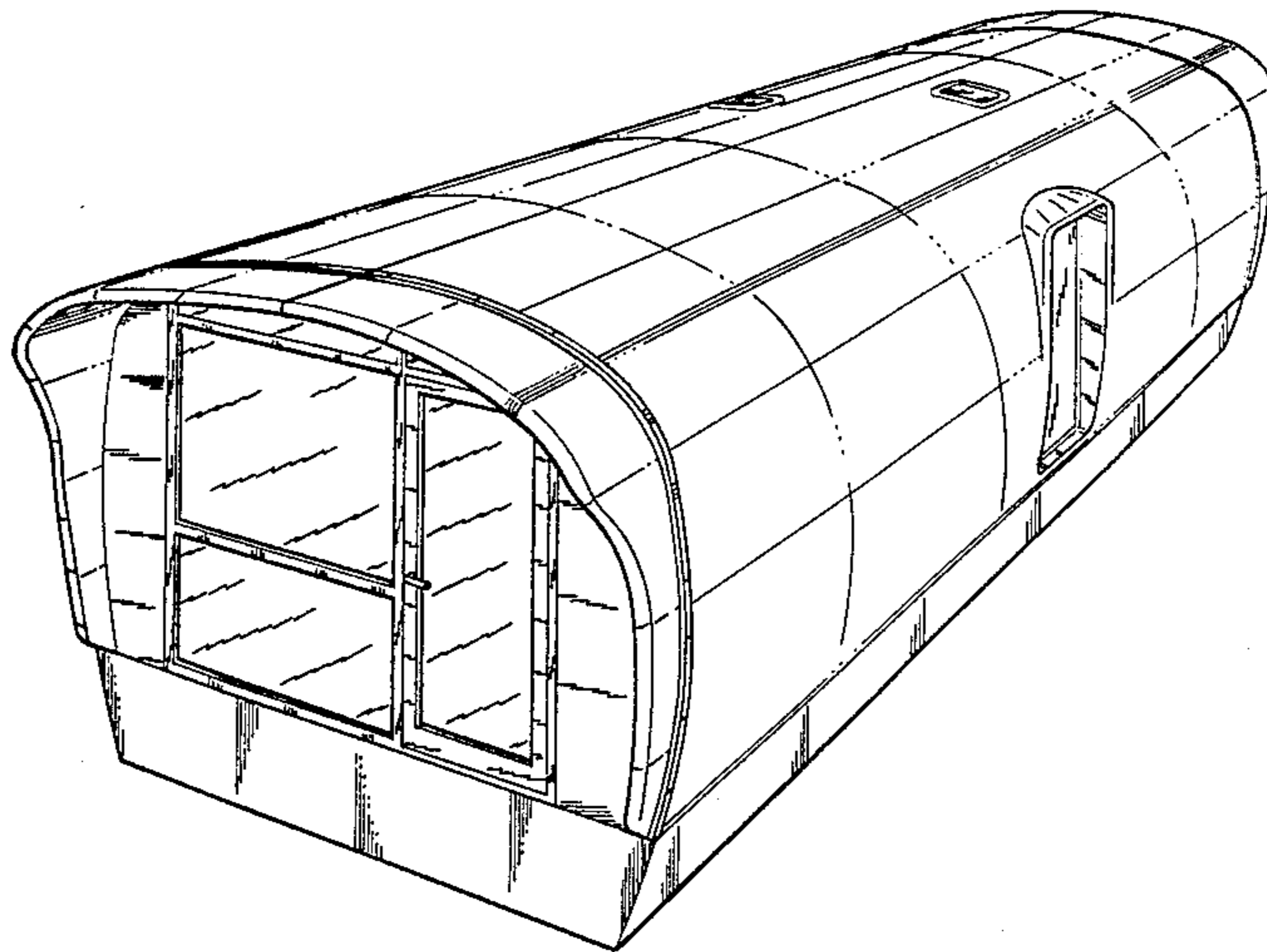

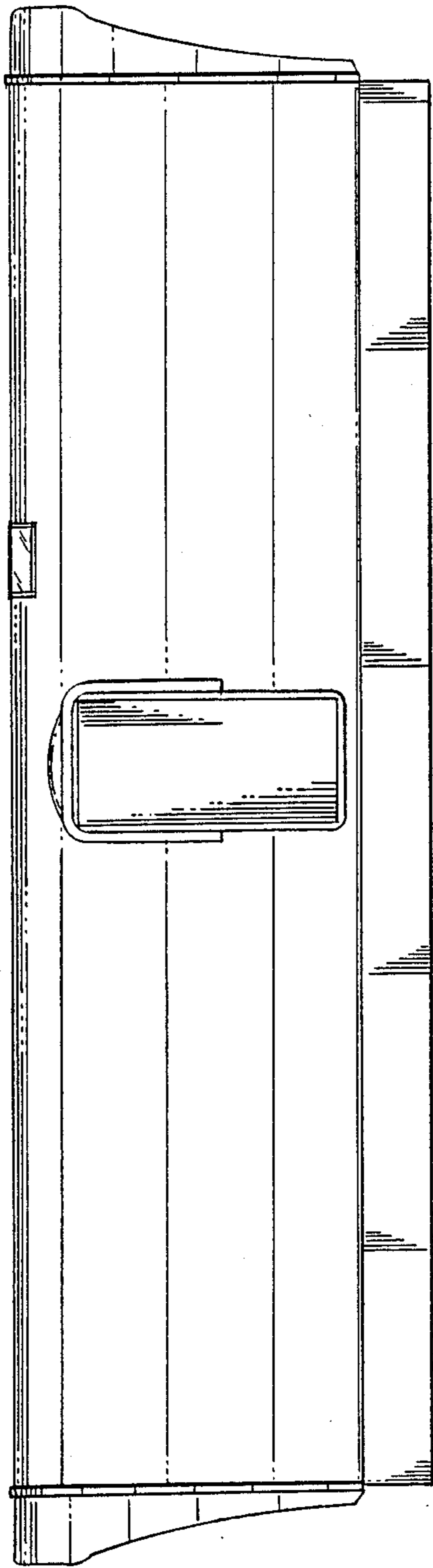

FIG. 1

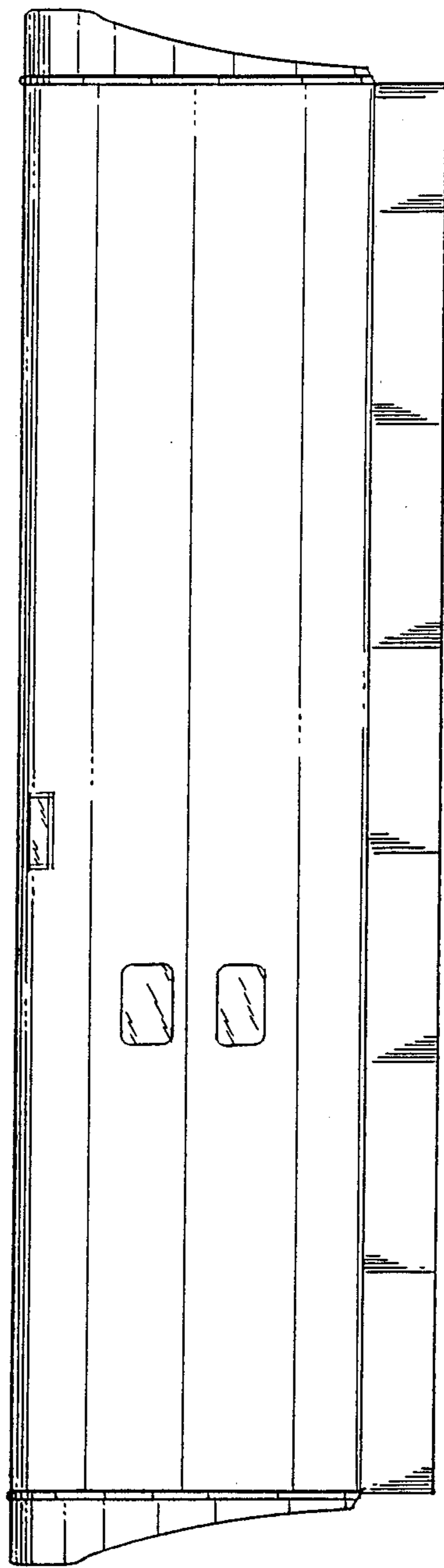

FIG. 2

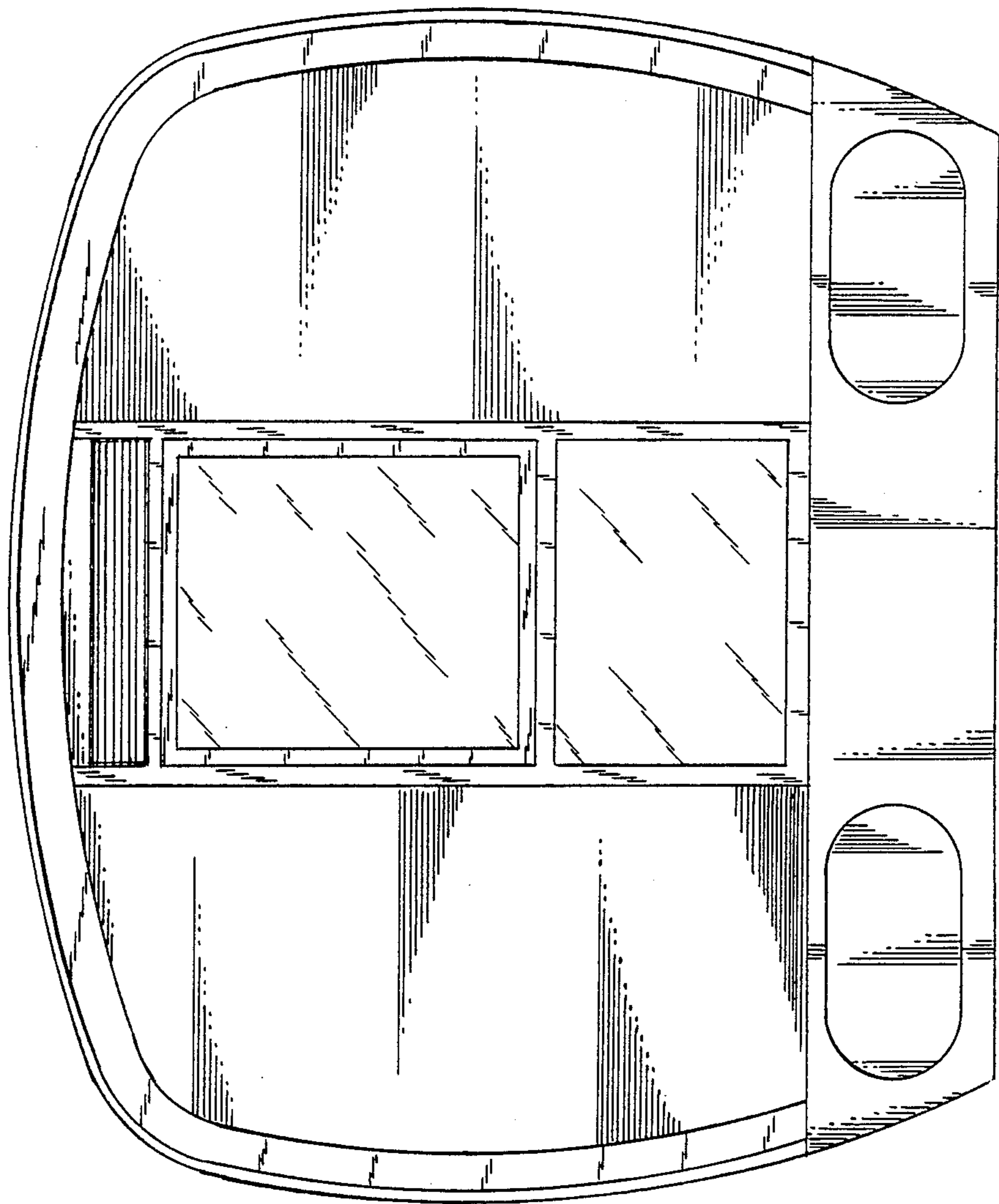

FIG. 3

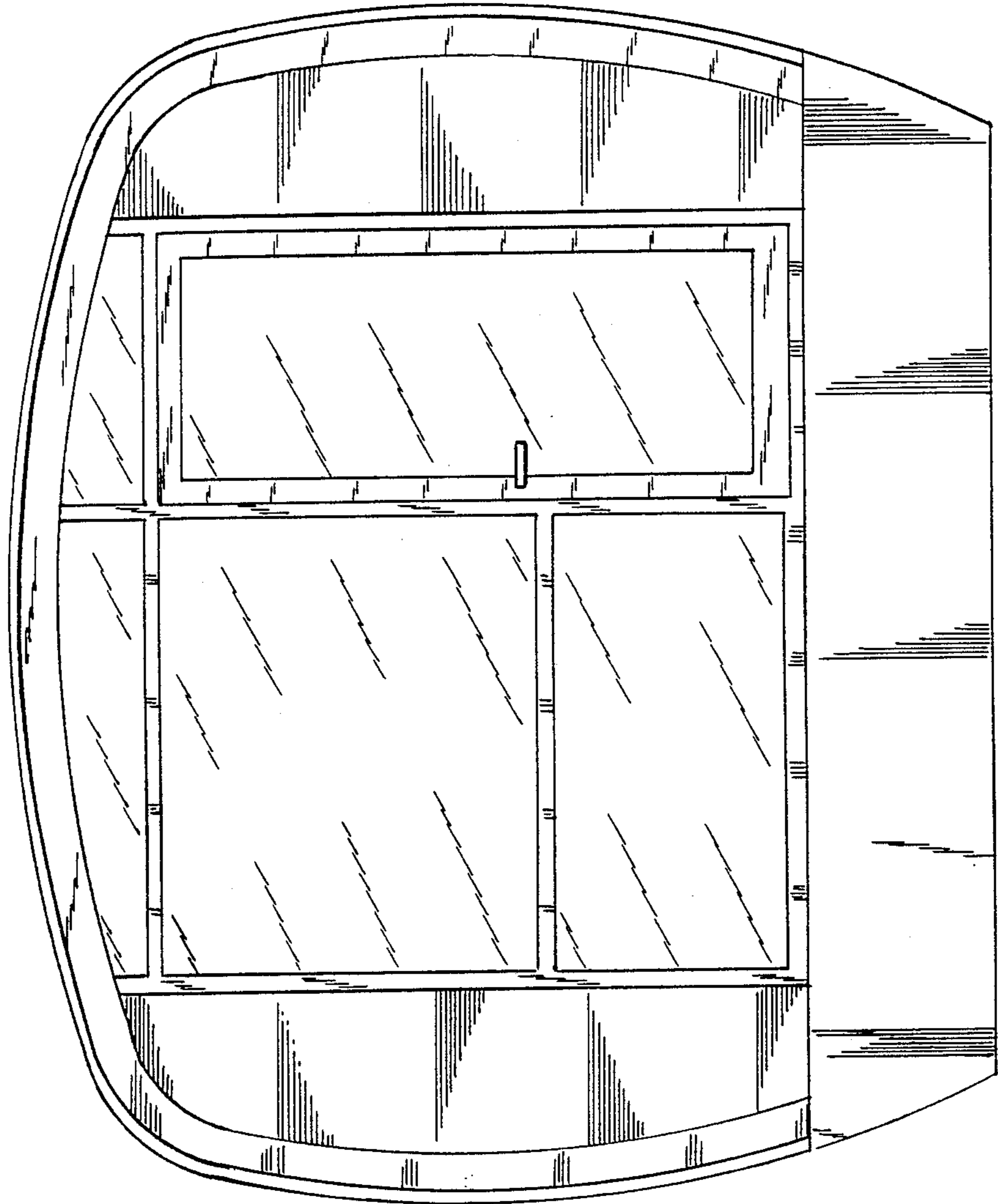

FIG. 4

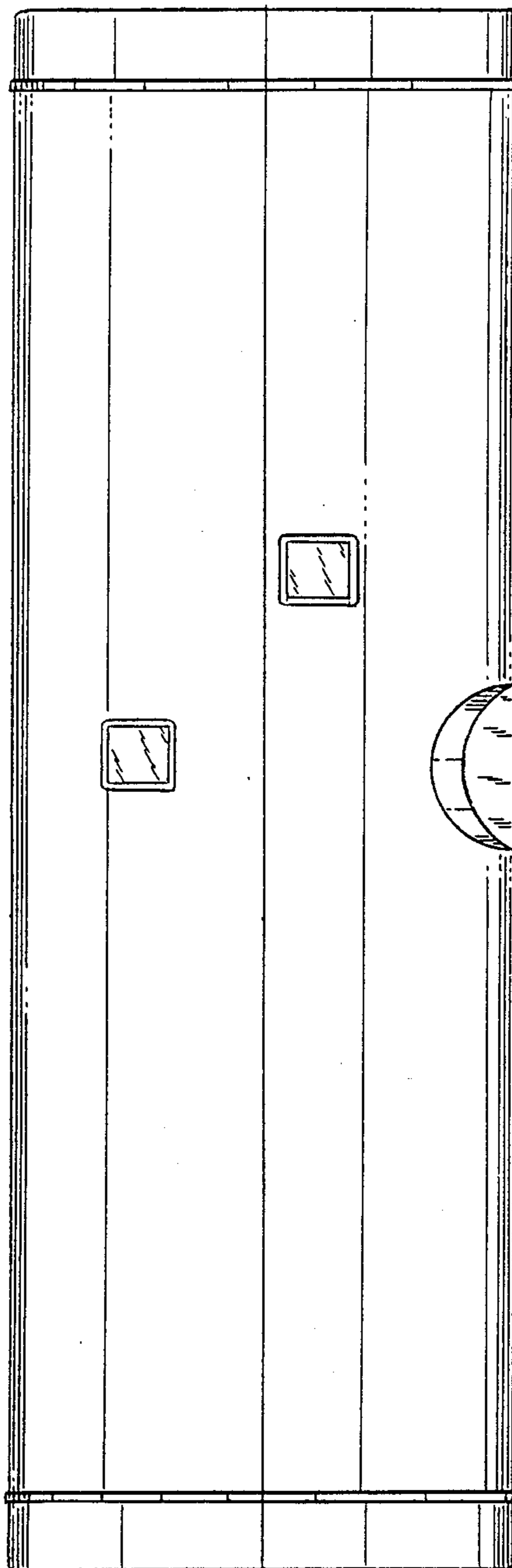

FIG. 5

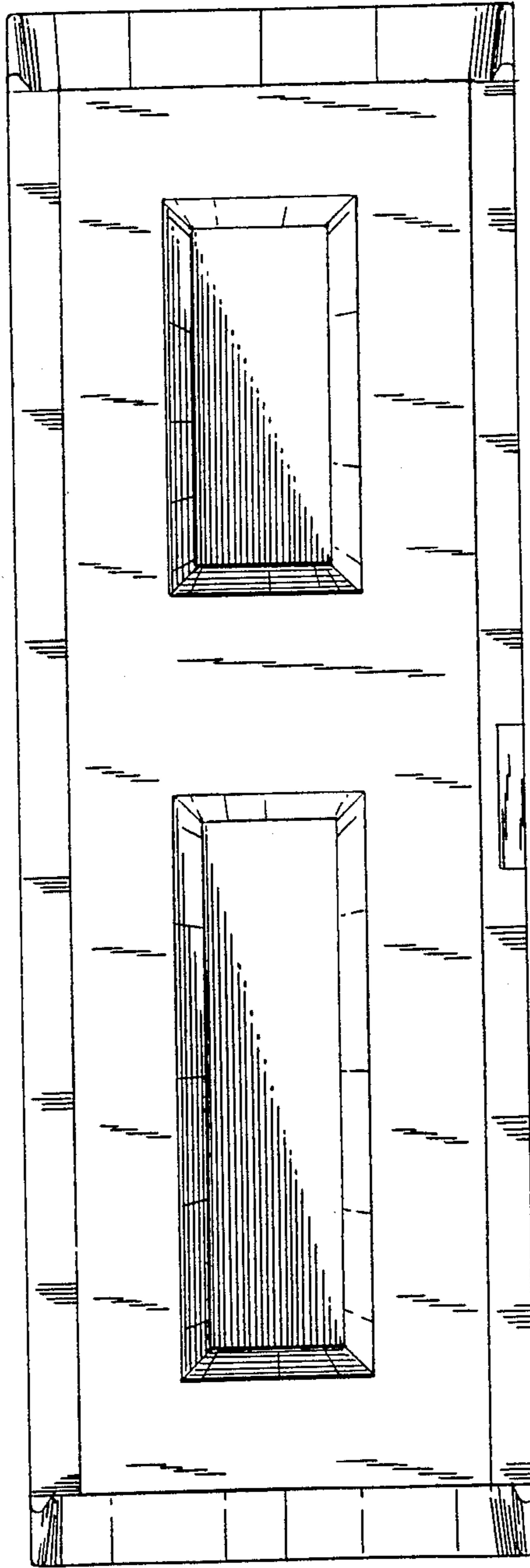

FIG. 6

