

[54] **EARRING OR SIMILAR ARTICLE**

[75] Inventor: **Paolo Bulgari, Rome, Italy**

[73] Assignee: **Partecipazioni Bulgari S.p.A., Rome, Italy**

[**] Term: **14 Years**

[21] Appl. No.: **280,265**

[22] Filed: **Dec. 5, 1988**

[30] **Foreign Application Priority Data**

Jun. 3, 1988 [IB] Int'l Pat. Institute DM/011089

[52] U.S. Cl. **D11/75; D11/42**

[58] Field of Search **D11/1-3, D11/40-49, 29, 75-76, 14, 56, 79-81, 226; 63/1.1, 2, 12, 13, 14.1**

[56] **References Cited**

U.S. PATENT DOCUMENTS

D. 292,686 11/1987 Bulgari D11/40

Primary Examiner—Louis S. Zarfes

Assistant Examiner—R. T. Seifert

Attorney, Agent, or Firm—Barnes, Kisselle, Raisch, Choate, Whittemore & Hulbert

[57] **CLAIM**

The ornamental design for an earring, as shown and described.

DESCRIPTION

FIG. 1 is a front elevational view of an earring showing my new design;

FIG. 2 is a right side elevational view of FIG. 1 in the open position;

FIG. 3 is a rear elevational view of FIG. 1 in the open position;

FIG. 4 is a left side elevational view of FIG. 1 in the open position;

FIG. 5 is a top plan view of FIG. 1 in the open position; and

FIG. 6 is a bottom plan view of FIG. 1 in the open position.

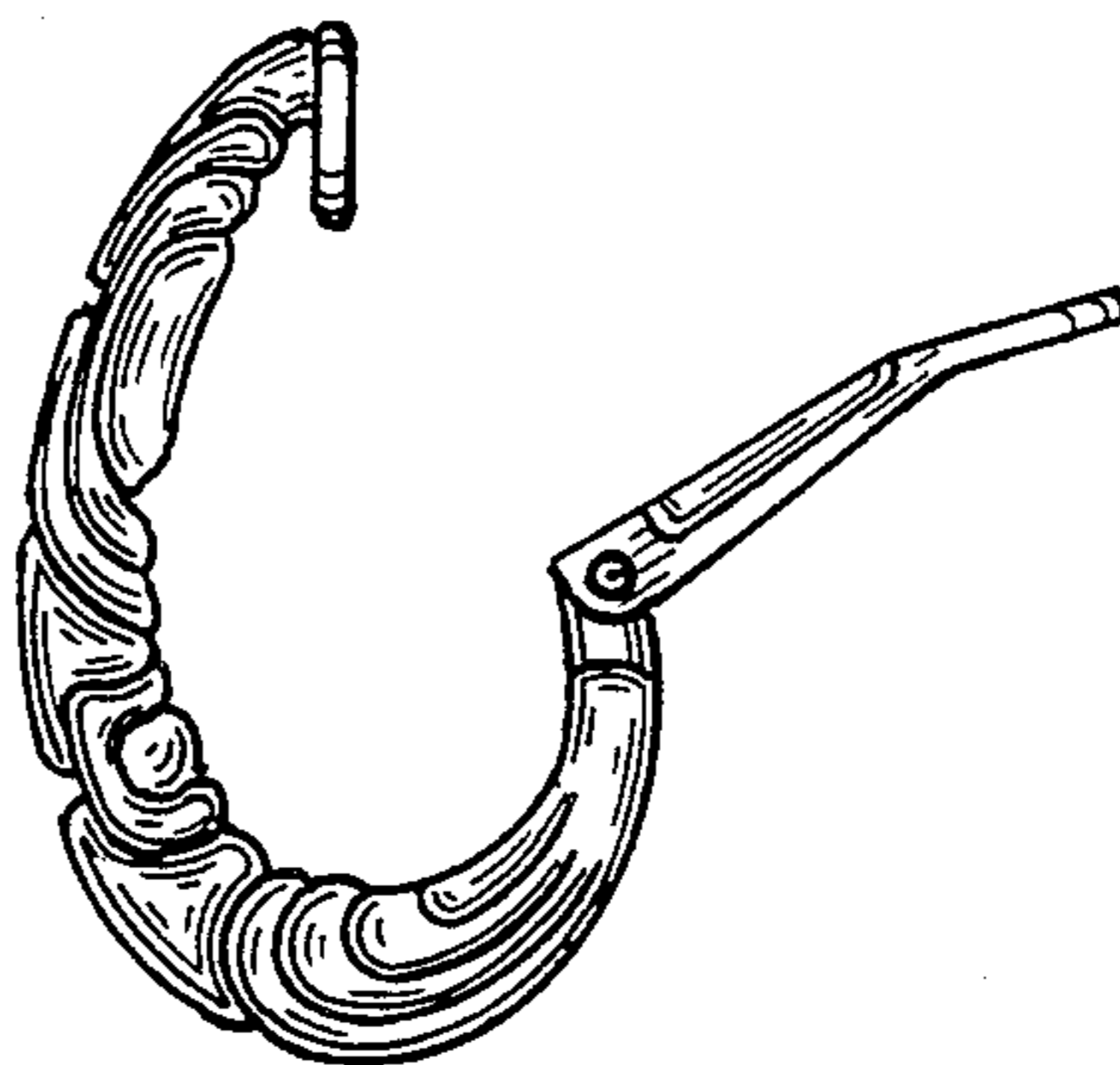
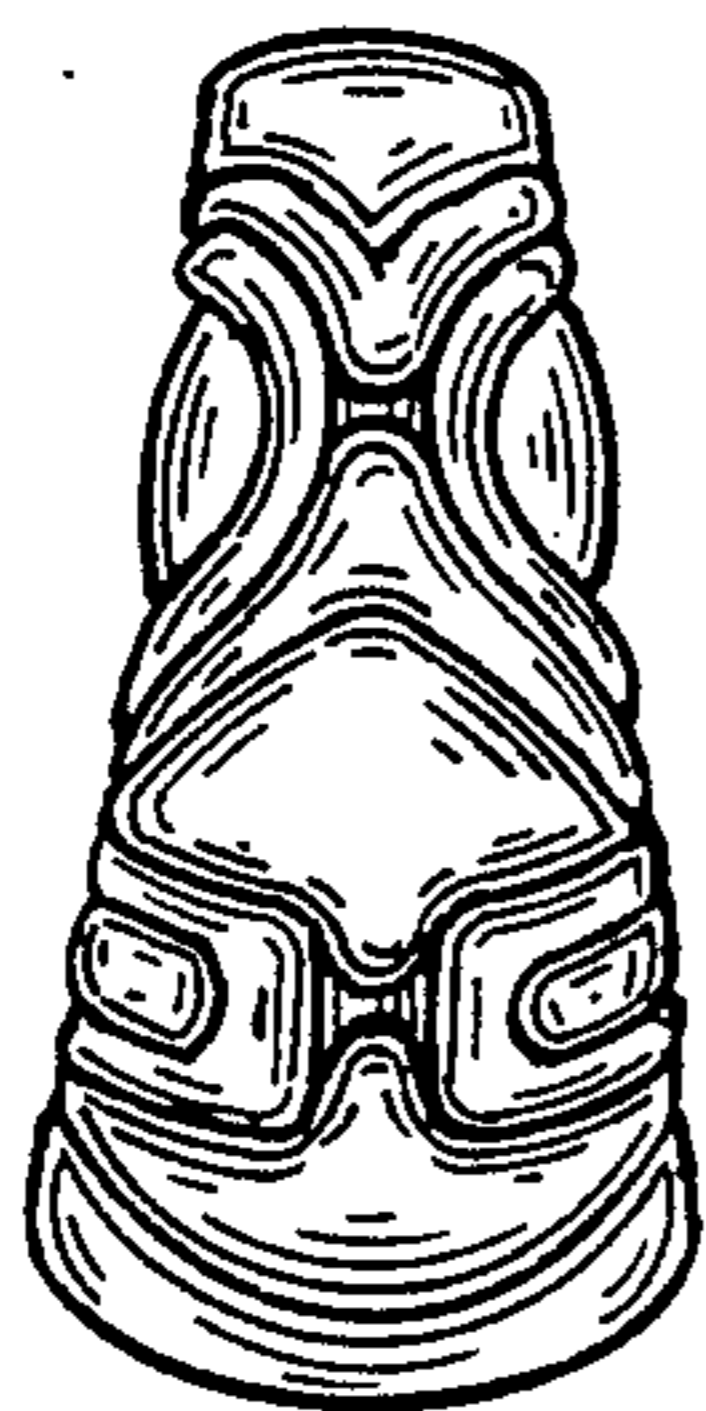

FIG.1

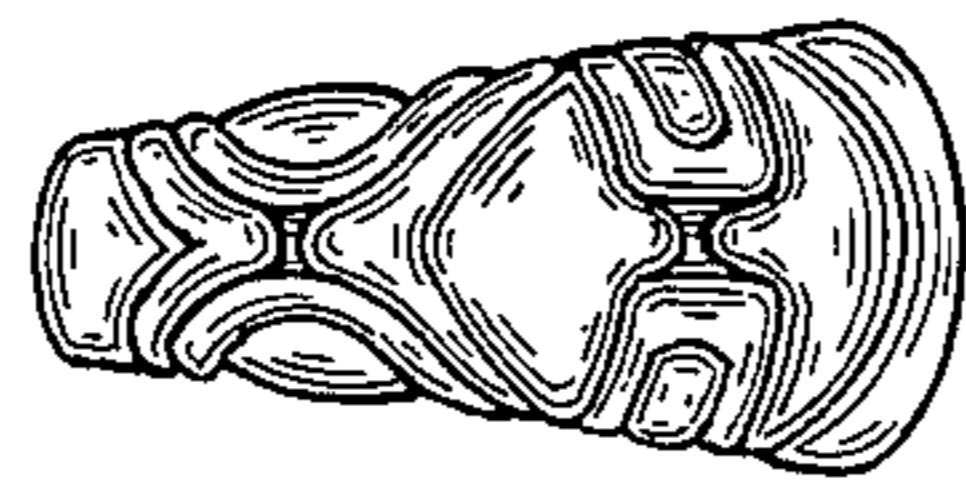

FIG.2

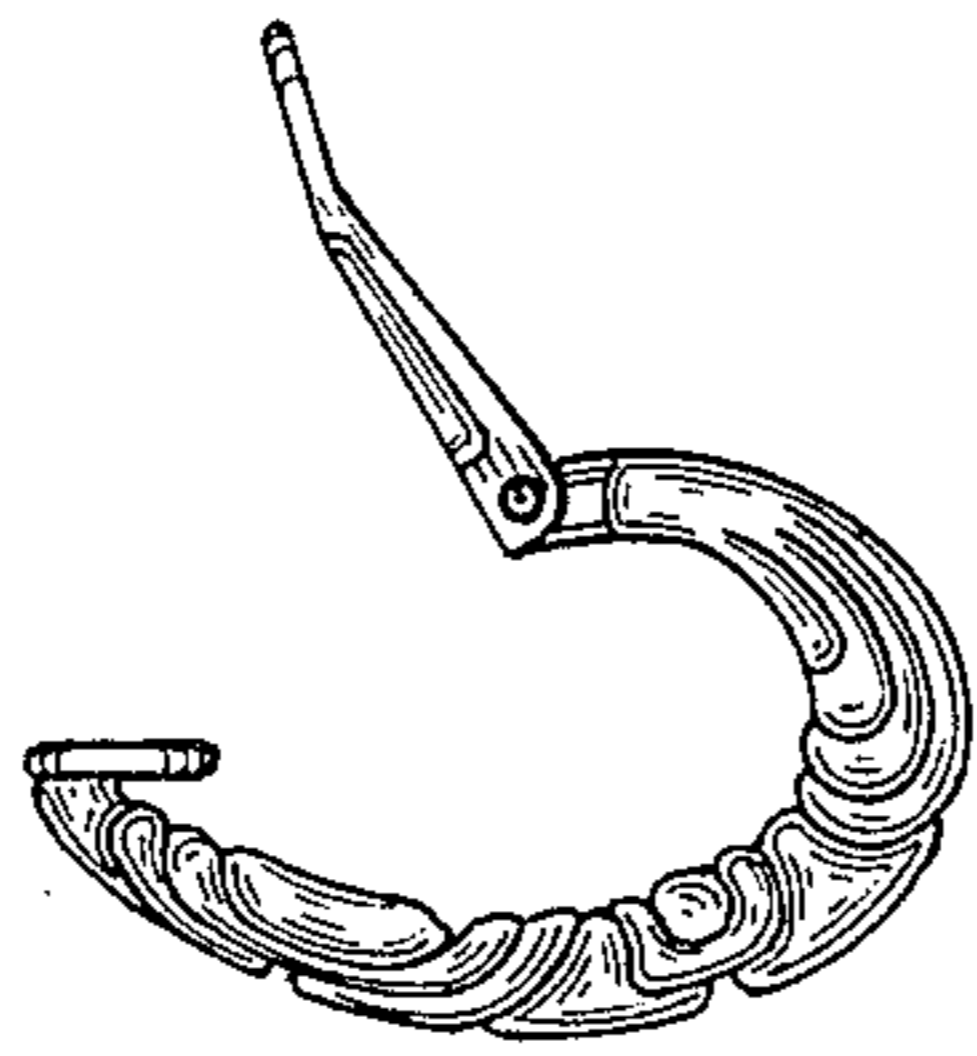

FIG.3

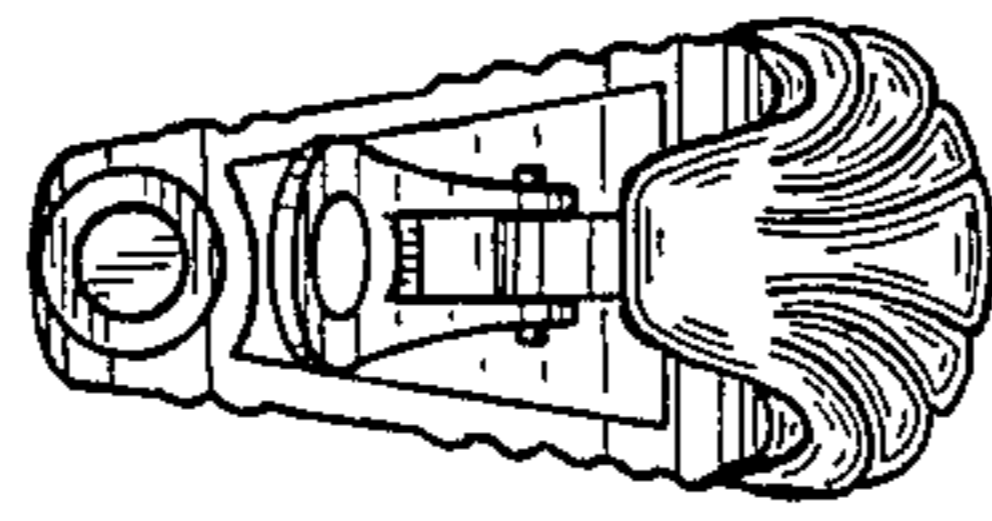

FIG.4

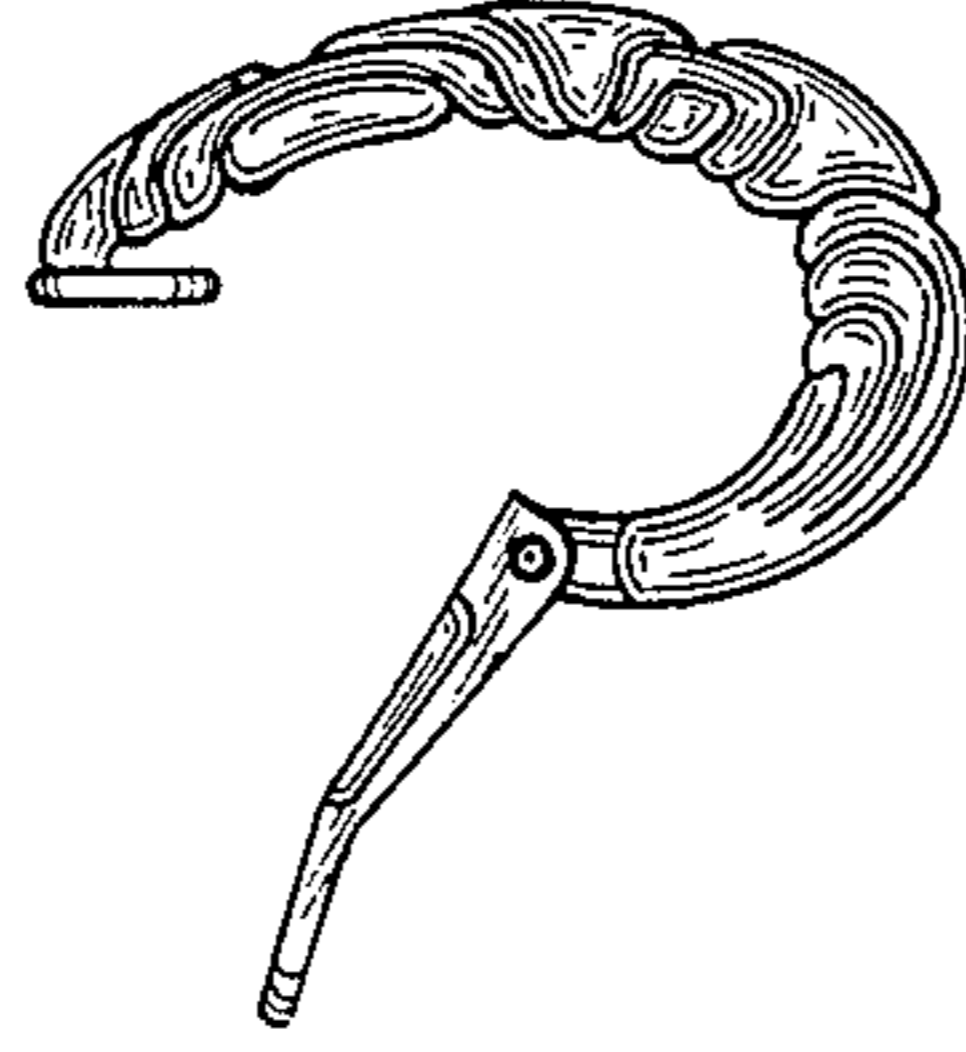

FIG.6

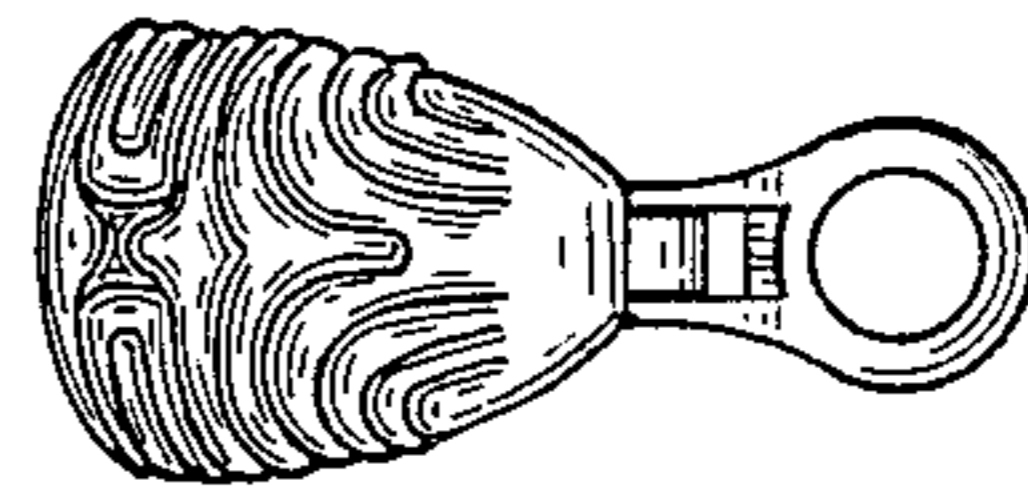

FIG.5

