

United States Patent [19]

Spaggiari

[11] Patent Number: **Des. 308,319**

[45] Date of Patent: **** Jun. 5, 1990**

[54] **PORTABLE COOLER**

[75] Inventor: **Alessandro Spaggiari, Correggio, Italy**

[73] Assignee: **Spal S.R.L., Italy**

[**] Term: **14 Years**

[21] Appl. No.: **35,135**

[22] Filed: **Apr. 6, 1987**

[30] **Foreign Application Priority Data**

Oct. 10, 1986 [IT] Italy 5024/86[U]

[52] U.S. Cl. **D7/605**

[58] Field of Search **D7/76, 77; D3/30.1; 220/412, DIG. 10, 371, 529, 457.2, 457.1, 457.7; 206/223, 541, 544, 549**

[56] **References Cited**

U.S. PATENT DOCUMENTS

D. 295,484 5/1988 Tarozzi et al. D7/77
3,938,688 2/1976 Ryan 206/541 X

Primary Examiner—Charles A. Rademaker
Assistant Examiner—Terry A. Pfeffer
Attorney, Agent, or Firm—Darby and Darby

[57] **CLAIM**

The ornamental design for portable cooler, as shown and described.

DESCRIPTION

FIG. 1 is a perspective view of a portable cooler showing my new design;
FIG. 2 is a left side elevational view thereof;
FIG. 3 is a rear elevational view thereof;
FIG. 4 is a top plan view thereof;
FIG. 5 is a bottom plan view thereof;
FIG. 6 is a front elevational view thereof.
The right side view thereof is the mirror image of the left side view.

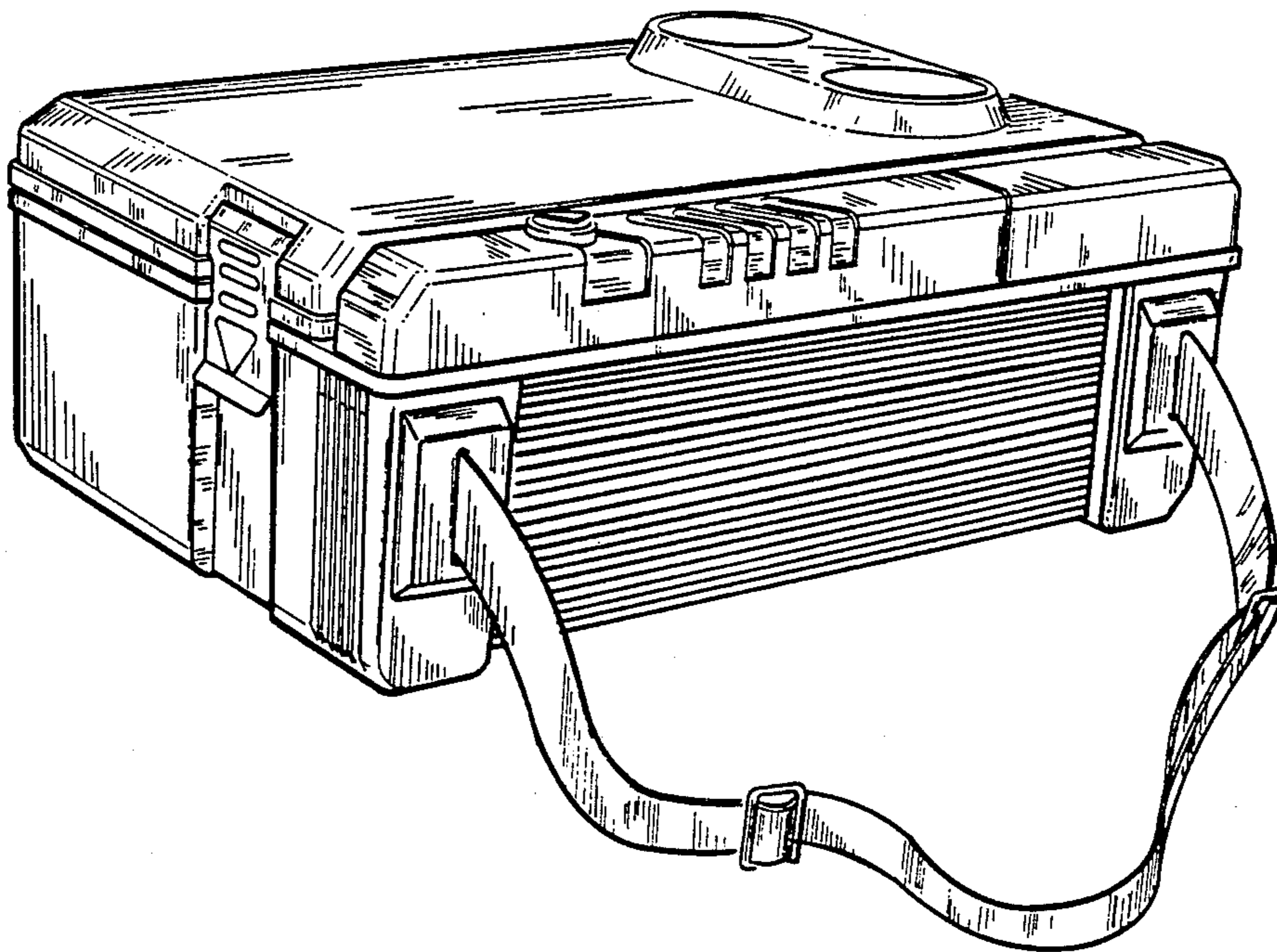

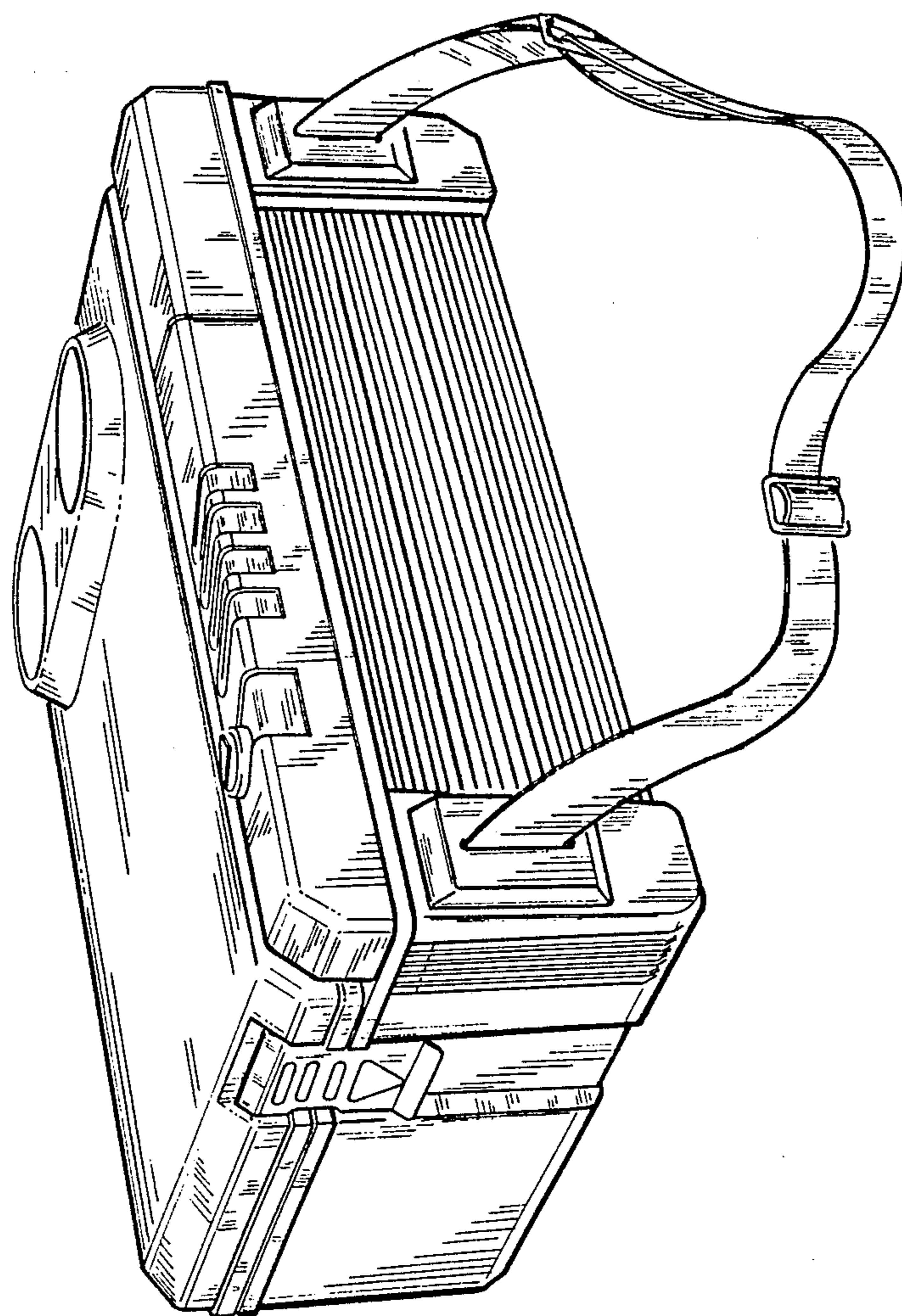

FIG 1

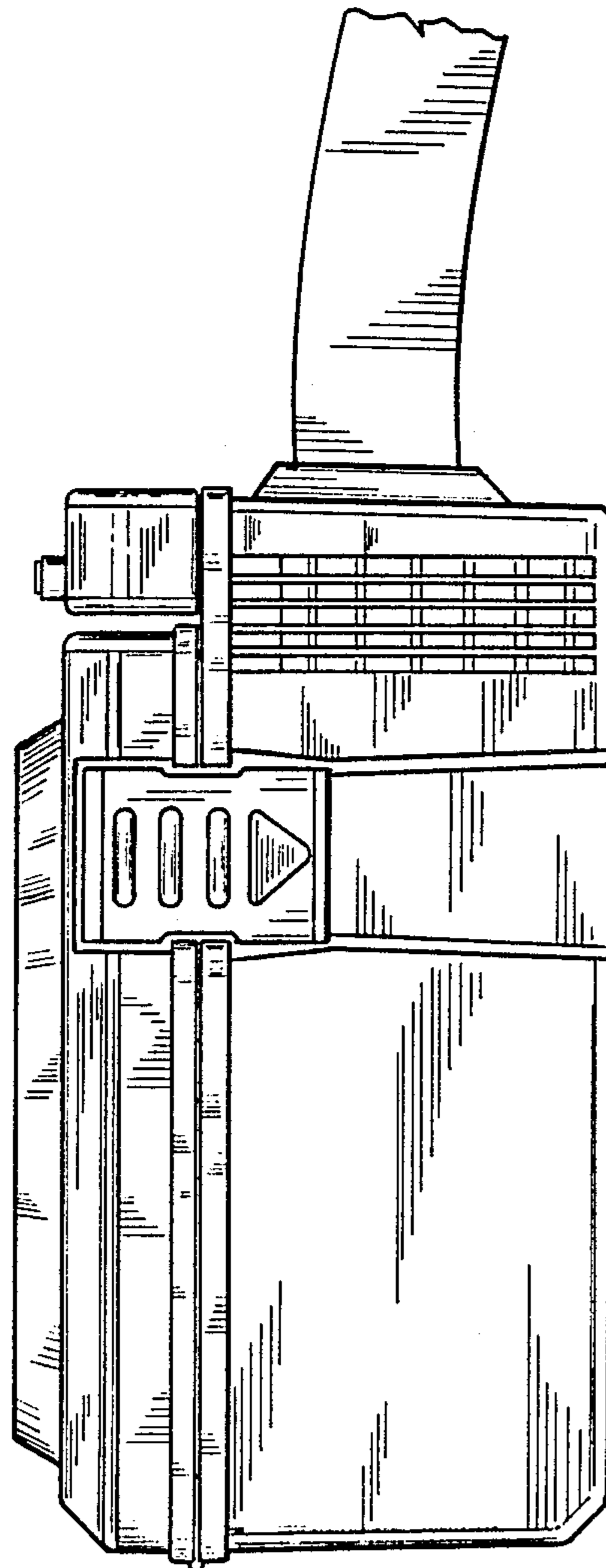

FIG 2

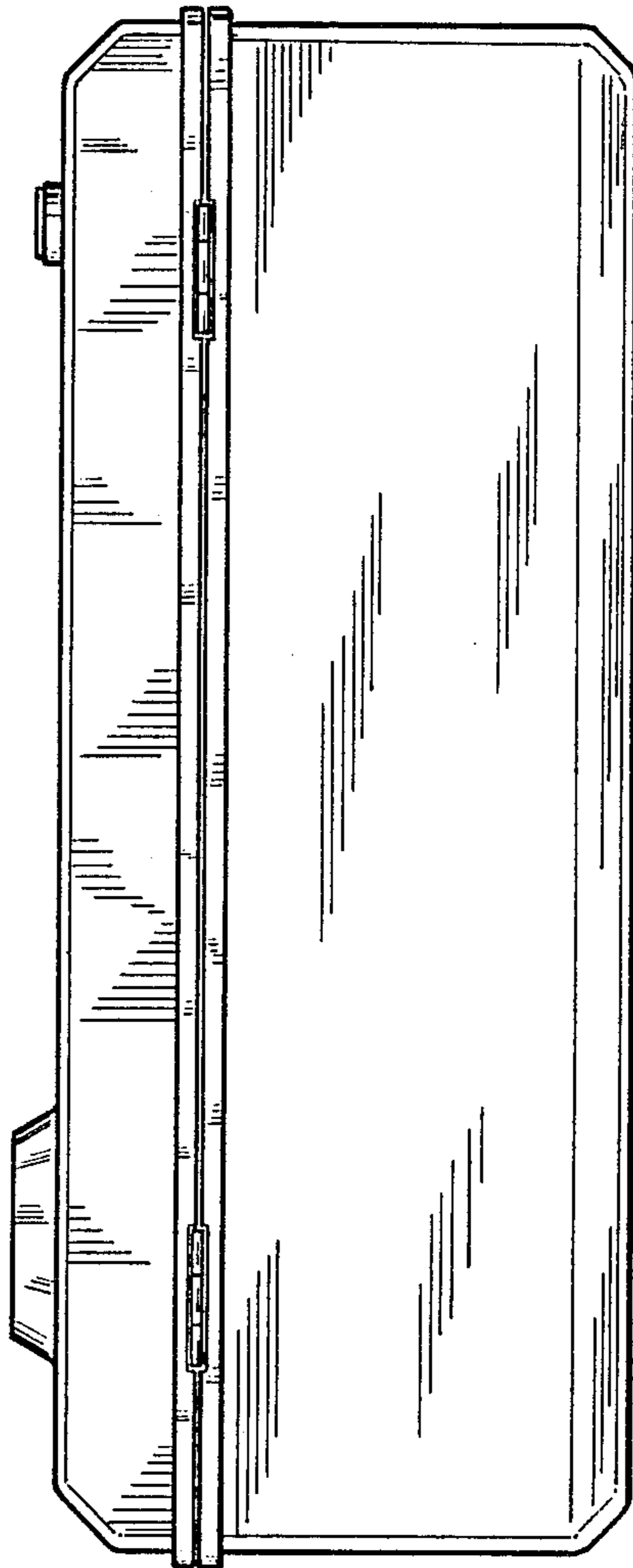

FIG 3

FIG 4

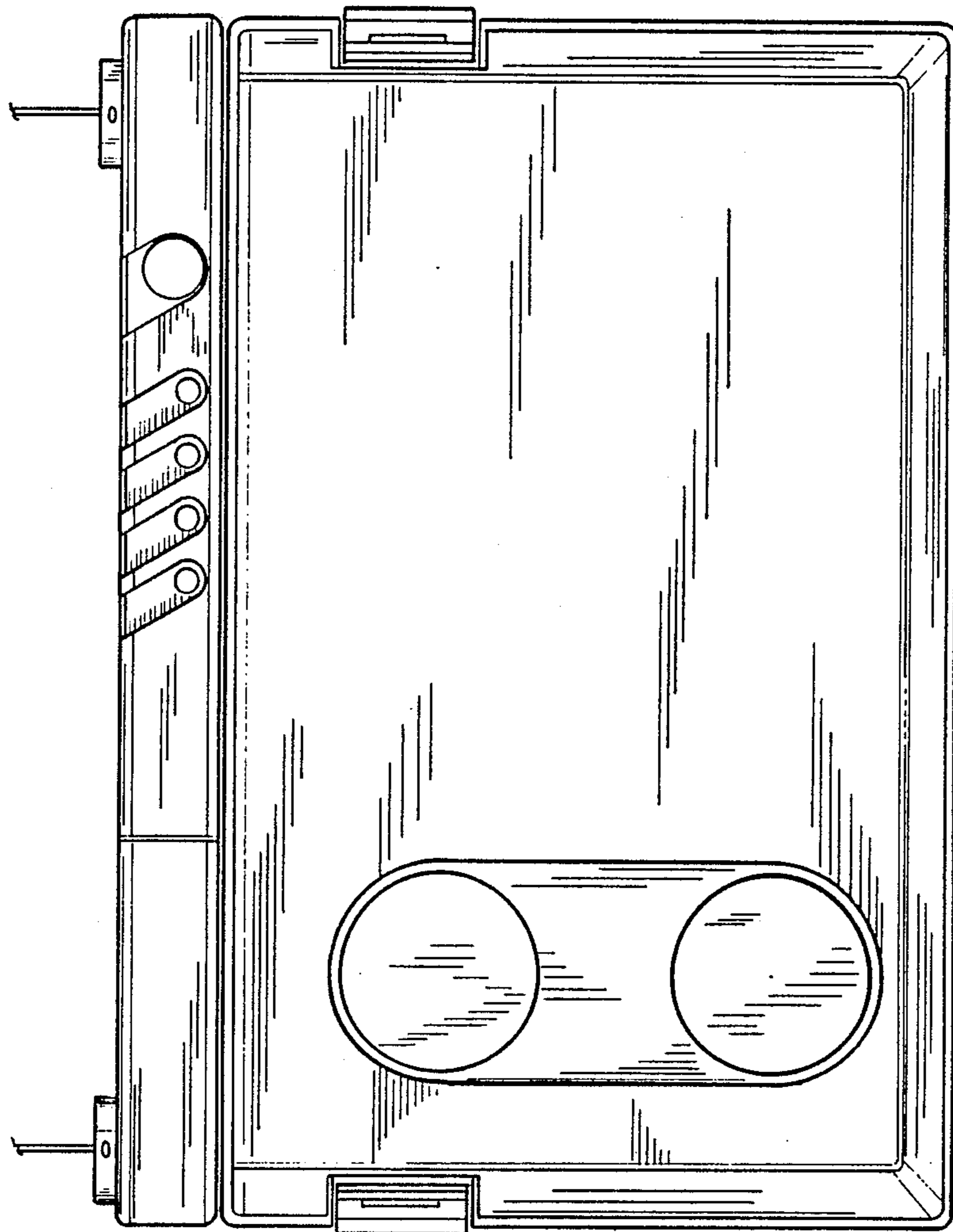
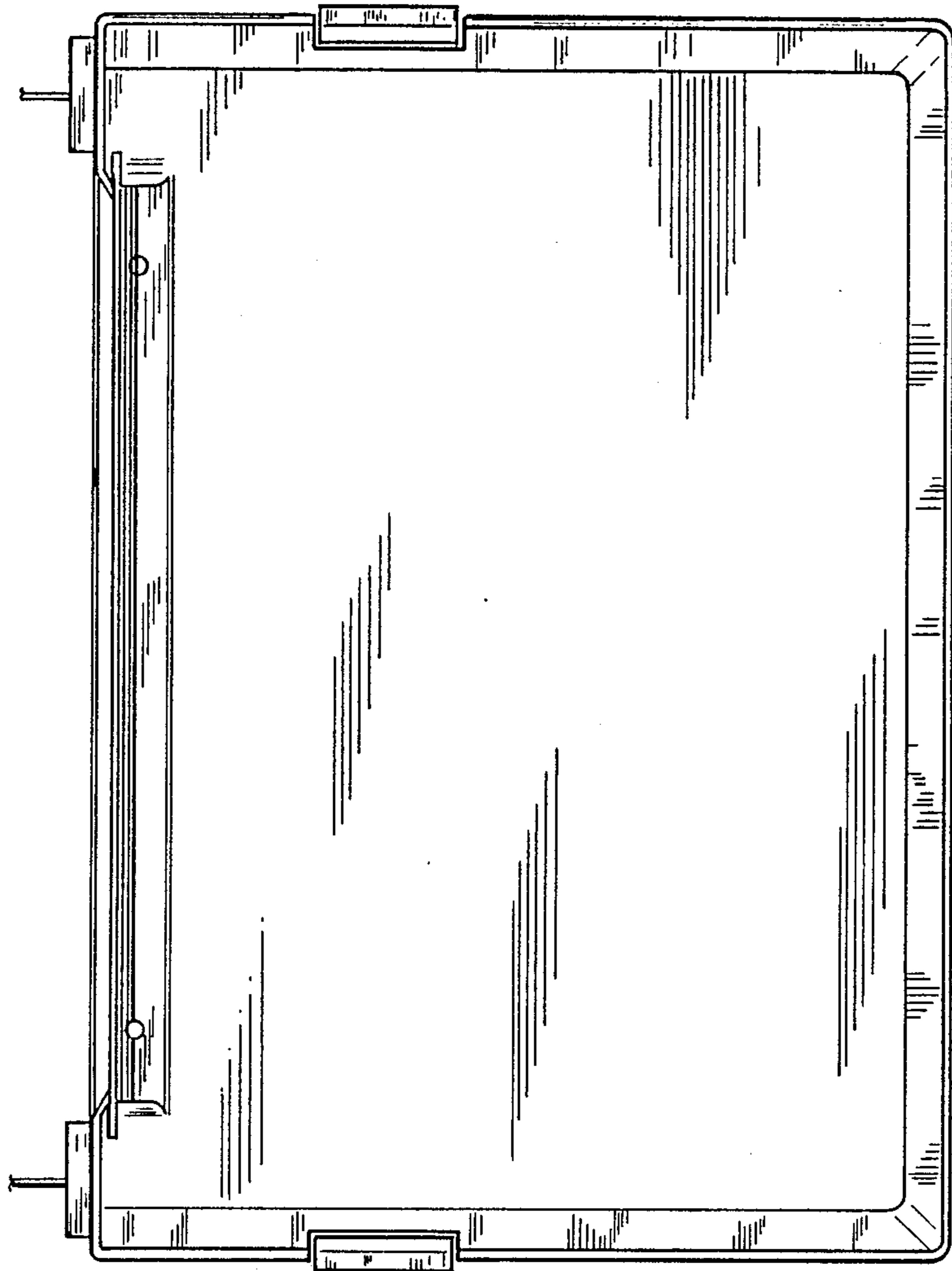

FIG 5



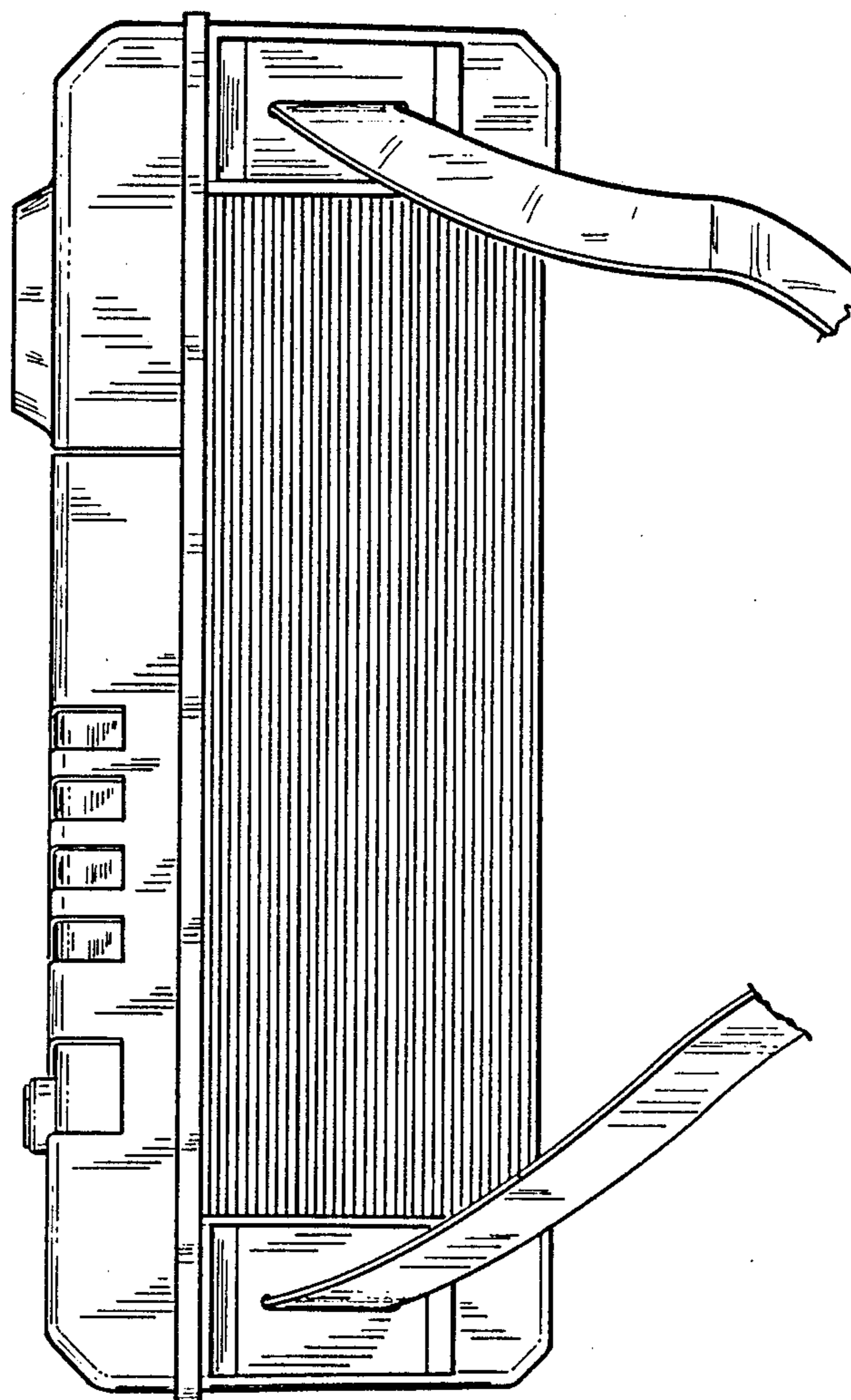

FIG 6