

[54] **LID FOR WASTE BASKET**

[75] **Inventor: Thomas E. Hanna, Wooster, Ohio**

[73] **Assignee: Rubbermaid Incorporated, Wooster, Ohio**

[**] **Term: 14 Years**

[21] **Appl. No.: 266,488**

[22] **Filed: Nov. 2, 1988**

[52] **U.S. Cl. D34/11**

[58] **Field of Search D34/1, 11, 7; 220/1 T, 220/337, 4 C, 1 R, 85 R, 334**

[56] **References Cited**

U.S. PATENT DOCUMENTS

- D. 217,498 5/1970 Dilyard D34/11
- D. 279,616 7/1985 Deacon D34/11
- D. 281,111 10/1985 McClelland .

OTHER PUBLICATIONS

Pp. 26 & 27, Rubbermaid Incorporated, Housewares Catalog, 1147 Akron Road, Wooster, Ohio 44691, Publication Date 1986.

P. 8, Dupol-Rubbermaid GmbH, An Der Trift, D-6072, Dreieich 4, West Germany, Publication Date 1986.

P. 14, Tucker Housewares, 25 Tucker Drive, Lsominster, Mass. 01453, Publication Date Unknown.

P. 14, Max Klein Co., Barabao, Wisc. 53913, Publication Date 1986.

P. 21, Loma/Rubberqueen, A Lancaster Colony Company, P.O. Box 40350, 9651 South I-35W, Fort Worth, Tex. 76140, Publication Date Unknown.

P. 17, Fesco, P.O. Box 891, Kankakee, Ill. 60901, Publication Date Unknown.

Pp. 14 & 15, Ingrid, 1419 Lake Cook Road, Suite 200, Deerfield, Ill. 60015, Publication Date Unknown.

Primary Examiner—Wallace R. Burke

Assistant Examiner—Kay H. Chin

Attorney, Agent, or Firm—Richard B. O'Planick

[57] **CLAIM**

The ornamental design for a lid for waste basket, as shown and described.

DESCRIPTION

FIG. 1 is a top and front perspective view of a lid for waste basket showing my new design;

FIG. 2 is a top and front perspective view thereof showing the lid on a waste receptacle. The broken lines are for illustrative purposes only;

FIG. 3 is a front elevational view thereof.

FIG. 4 is a rear elevational view thereof.

FIG. 5 is a top plan view thereof.

FIG. 6 is a bottom plan view thereof.

FIG. 7 is a side elevational view thereof; the opposite side being a mirror image.

FIG. 8 is a cross sectional view thereof taken along the line 8 FIG. 5.

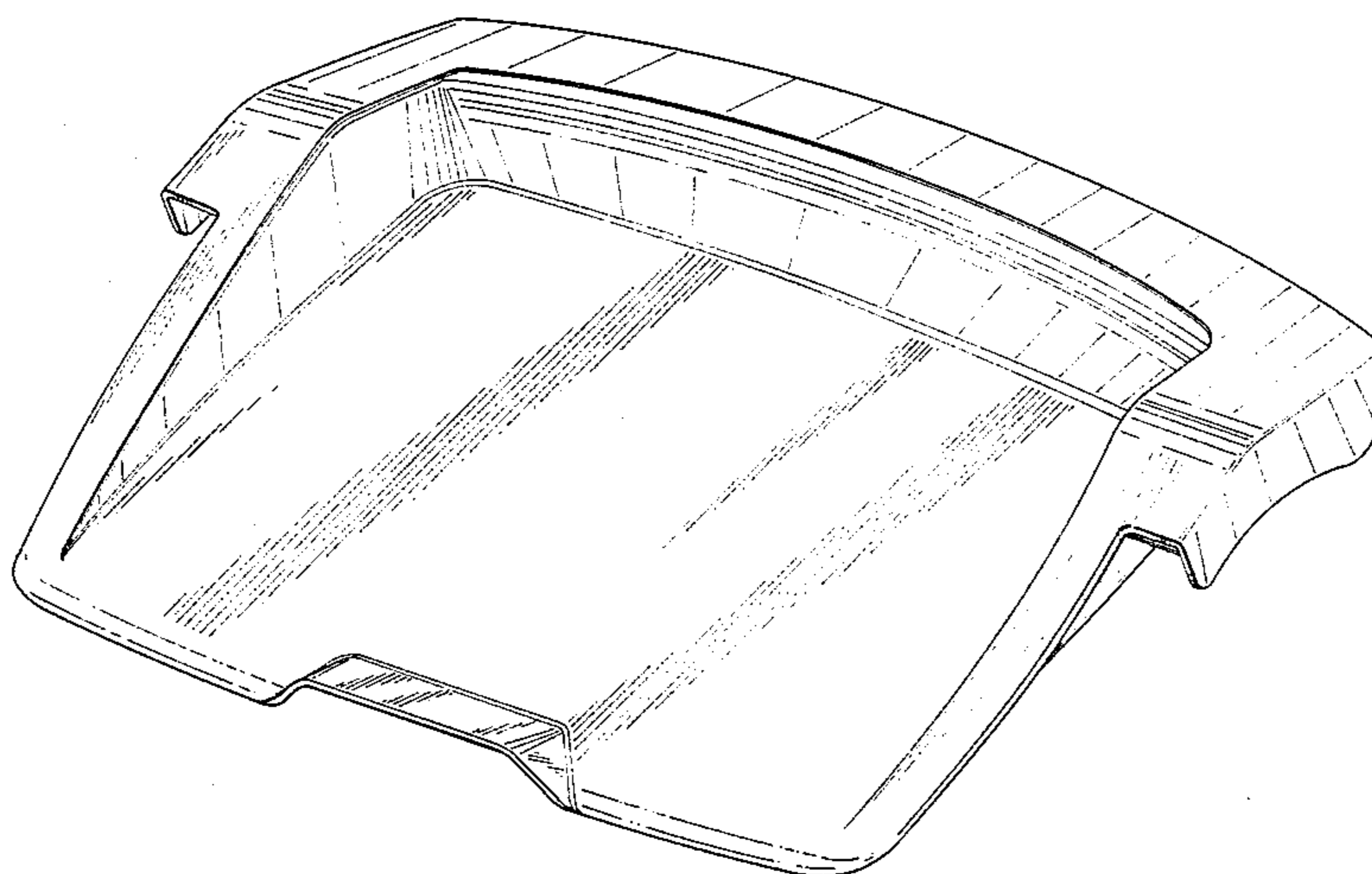

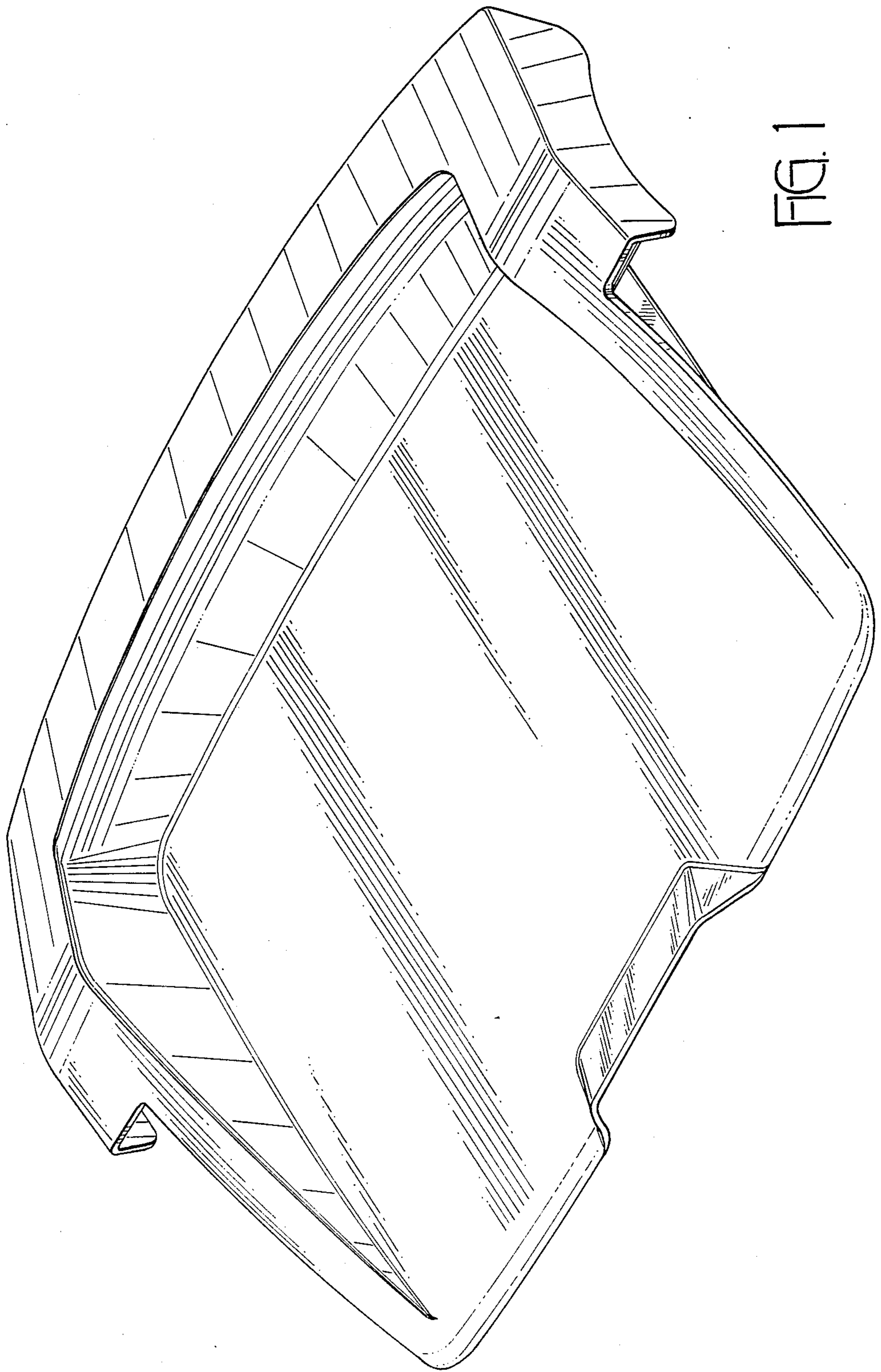

FIG. 1

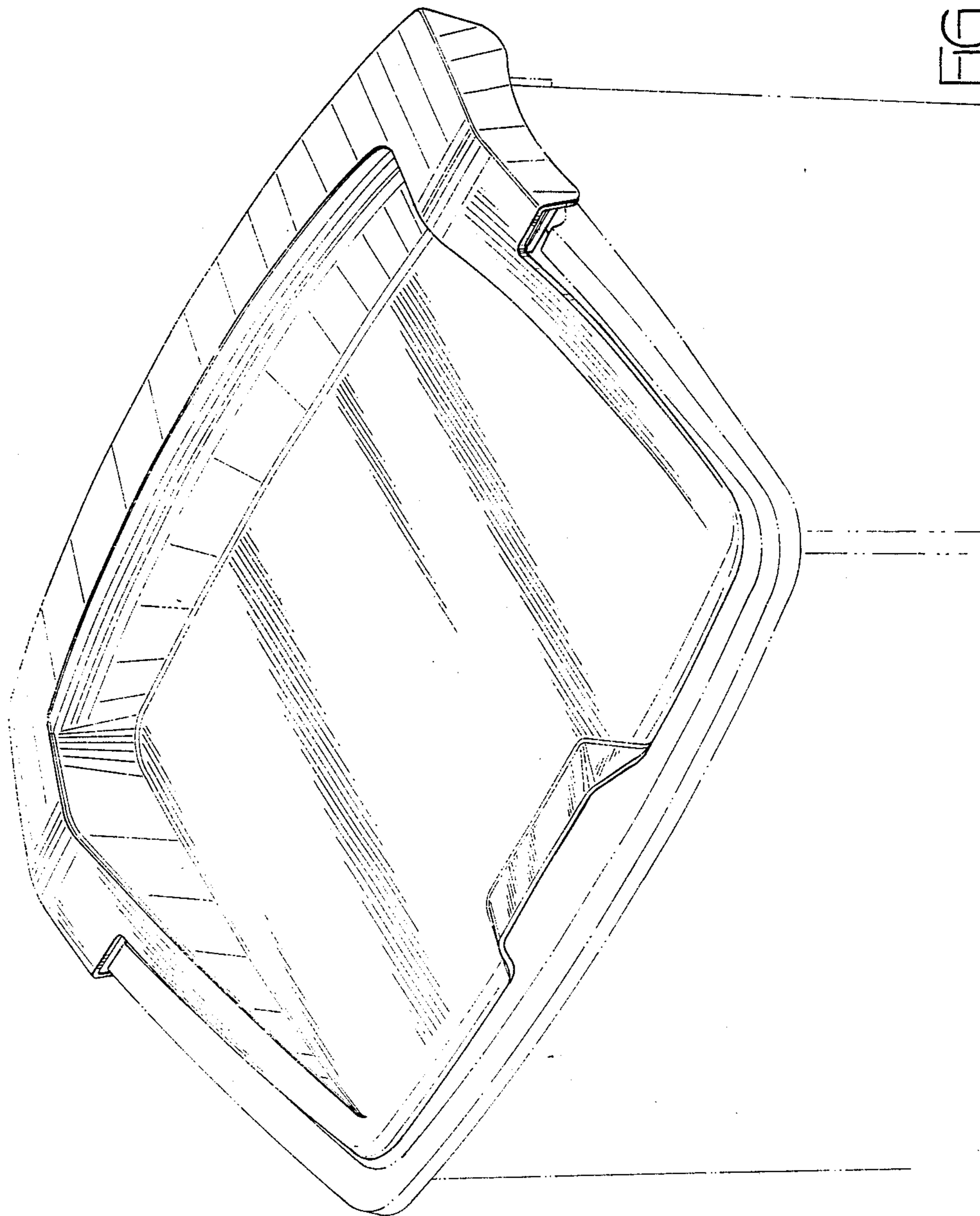

FIG. 2

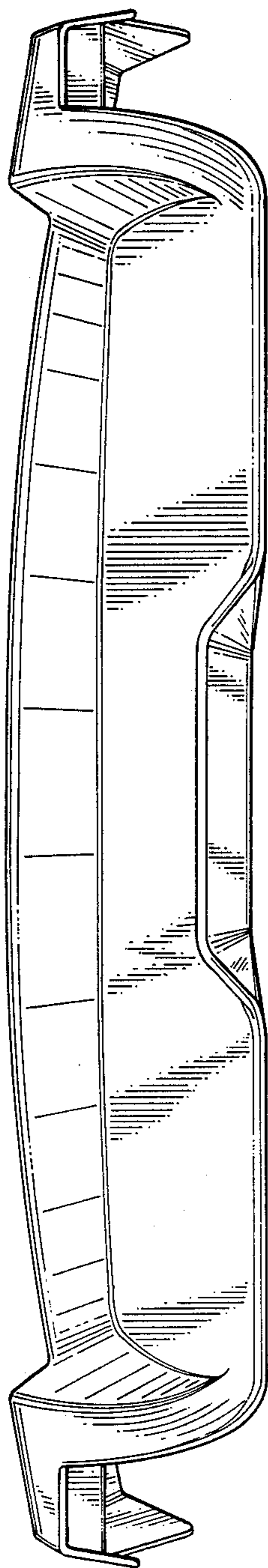

FIG. 3

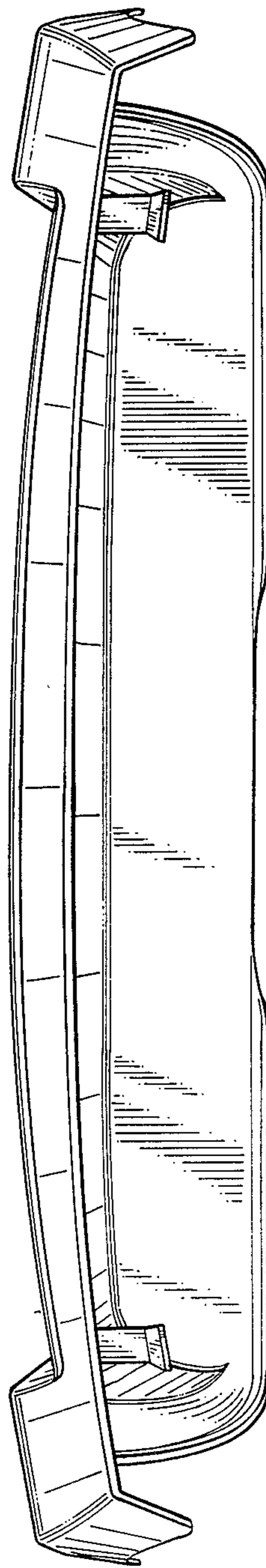
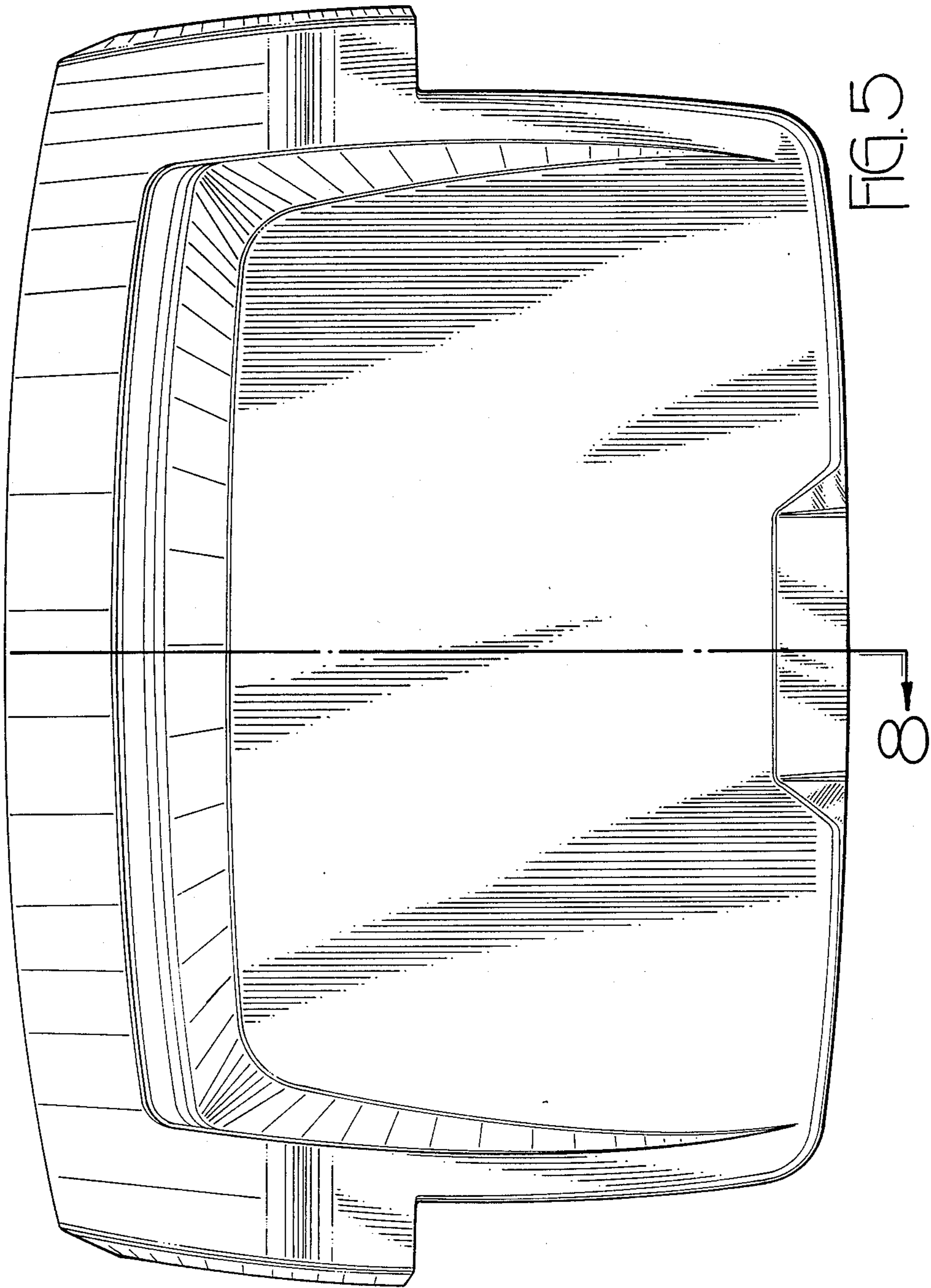

FIG. 4



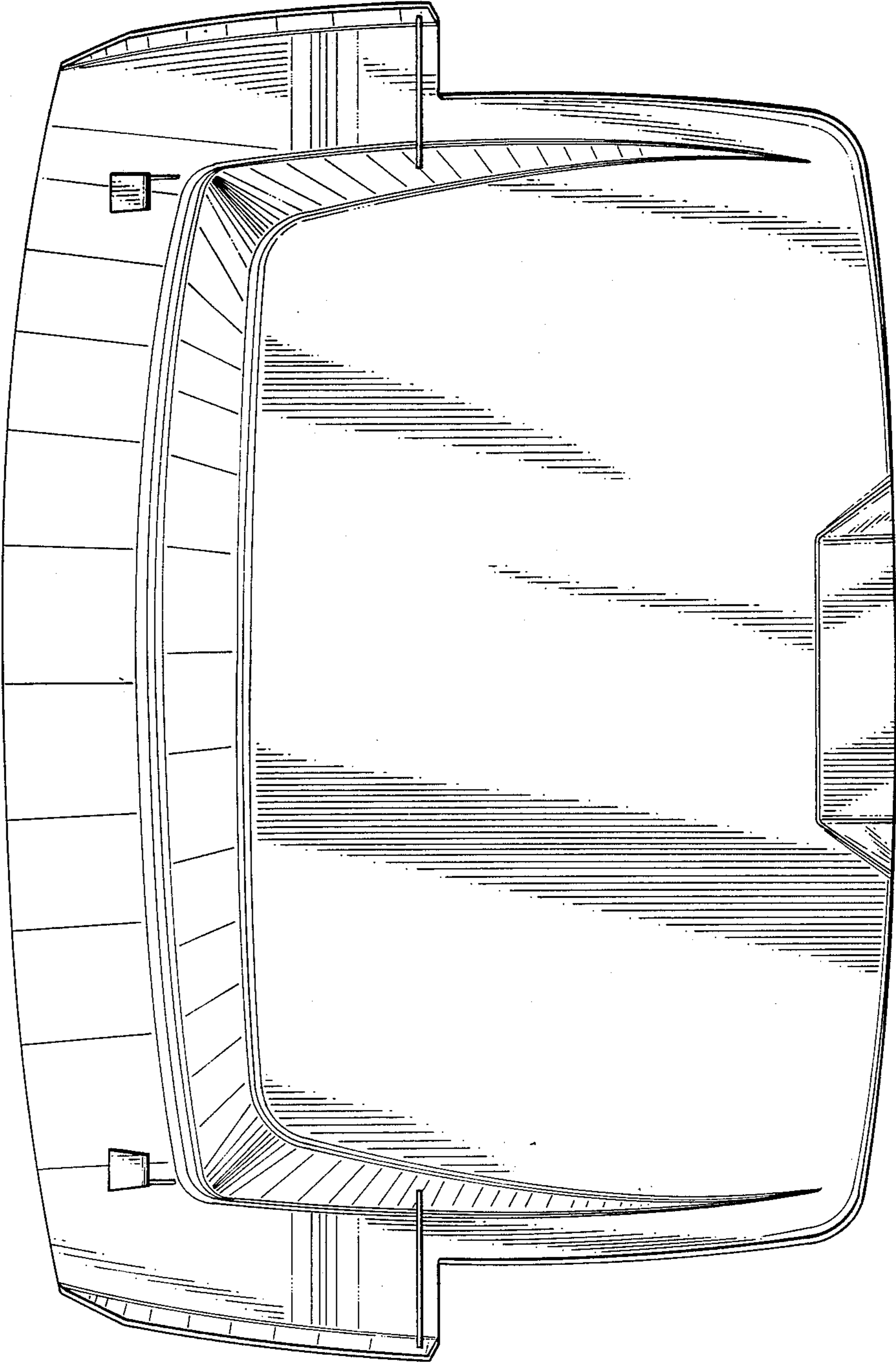

FIG. 6

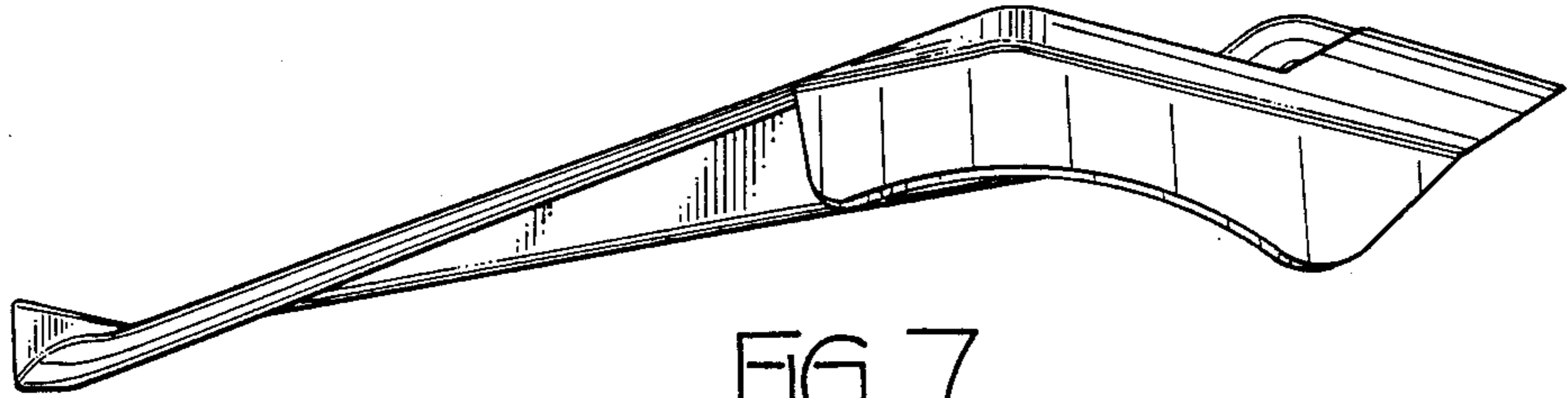

FIG. 7

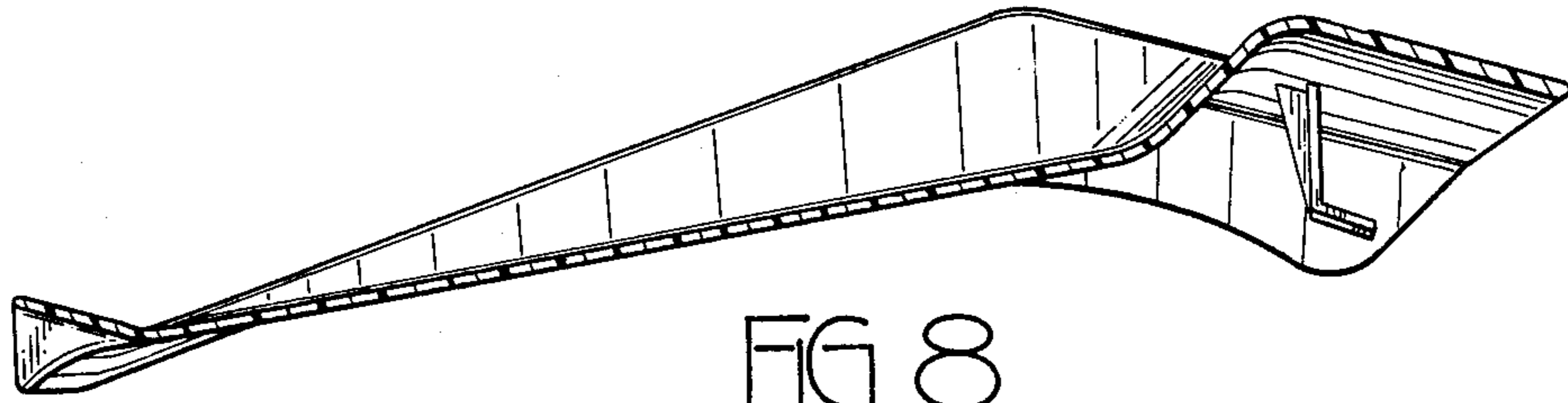

FIG. 8