

[54] **MINIATURE SEWING BOX**
 [76] **Inventor: John S. Doyel, 404 W. 20th St., New York, N.Y. 10011**
 [**] **Term: 14 Years**
 [21] **Appl. No.: 927,410**
 [22] **Filed: Nov. 4, 1986**
 [52] **U.S. Cl. D3/20; D3/25**
 [58] **Field of Search D9/423, 303; 190/115, 190/119; D3/18, 20-29, 73, 30.1, 36; 206/227, 380, 388, 574, 823; 223/99, 106-109 A, 111; D28/38**

4,504,000 3/1985 Doyel D3/25 X

Primary Examiner—Louis S. Zarfes
Attorney, Agent, or Firm—Cooper & Dunham

[57] **CLAIM**

The ornamental design for a miniature sewing box, as shown and described.

DESCRIPTION

FIG. 1 is a front elevational view of a miniature sewing box showing my new design, the rear being a mirror image except for the handle as seen in FIG. 8;
 FIG. 2 is a right side elevational view, the left side being a mirror image;
 FIG. 3 is a top plan view;
 FIG. 4 is a bottom plan view;
 FIG. 5 is a bottom plan view of the box in open position;
 FIG. 6 is a top plan view thereof;
 FIG. 7 is a right side elevational view thereof, the left side being a mirror image; and
 FIG. 8 is a partial rear elevational view showing the handle portion.

[56] **References Cited**
U.S. PATENT DOCUMENTS
 D. 39,754 1/1909 Foley D3/25 X
 D. 221,603 8/1971 Levin D3/73 X
 D. 258,847 4/1981 Schönfeld D3/73 X
 2,060,466 11/1936 Gutenstein 206/823 X
 2,444,511 7/1948 Kaufmann 190/119

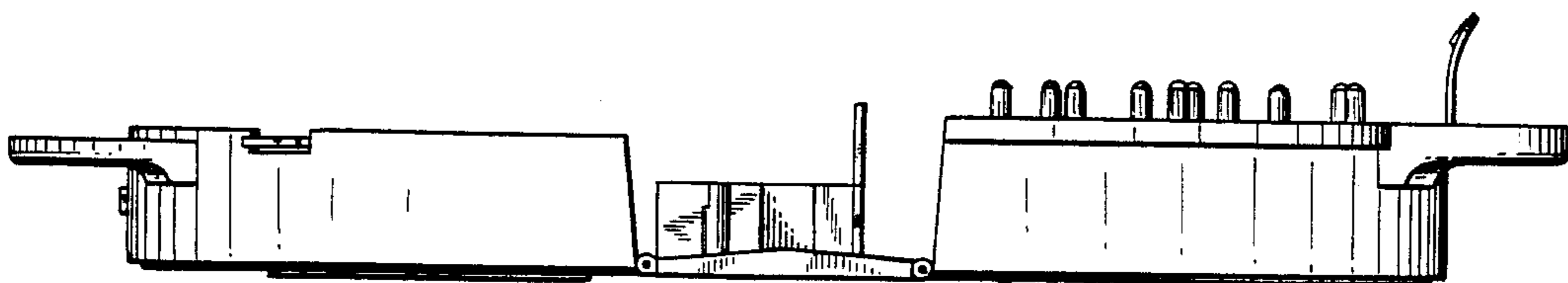
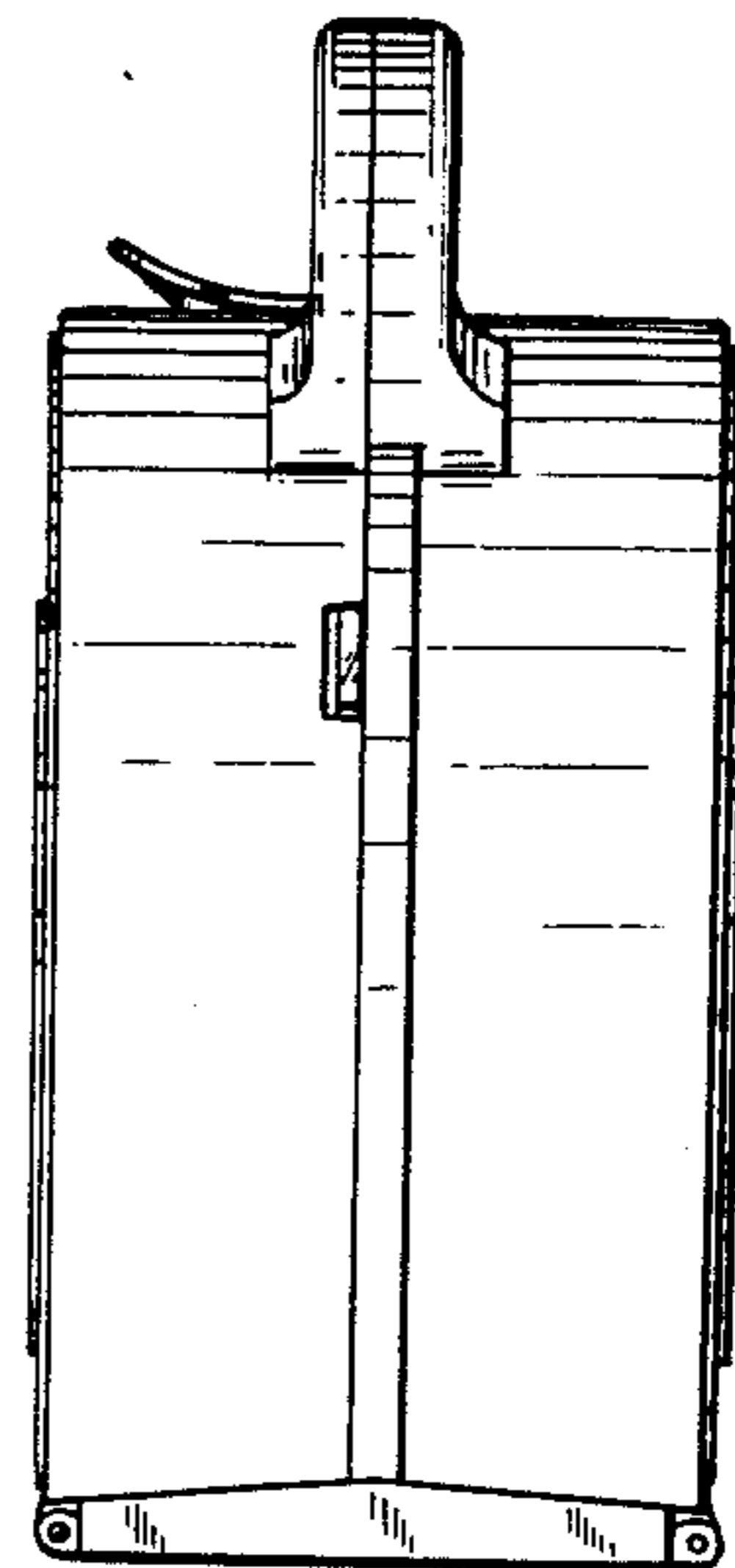
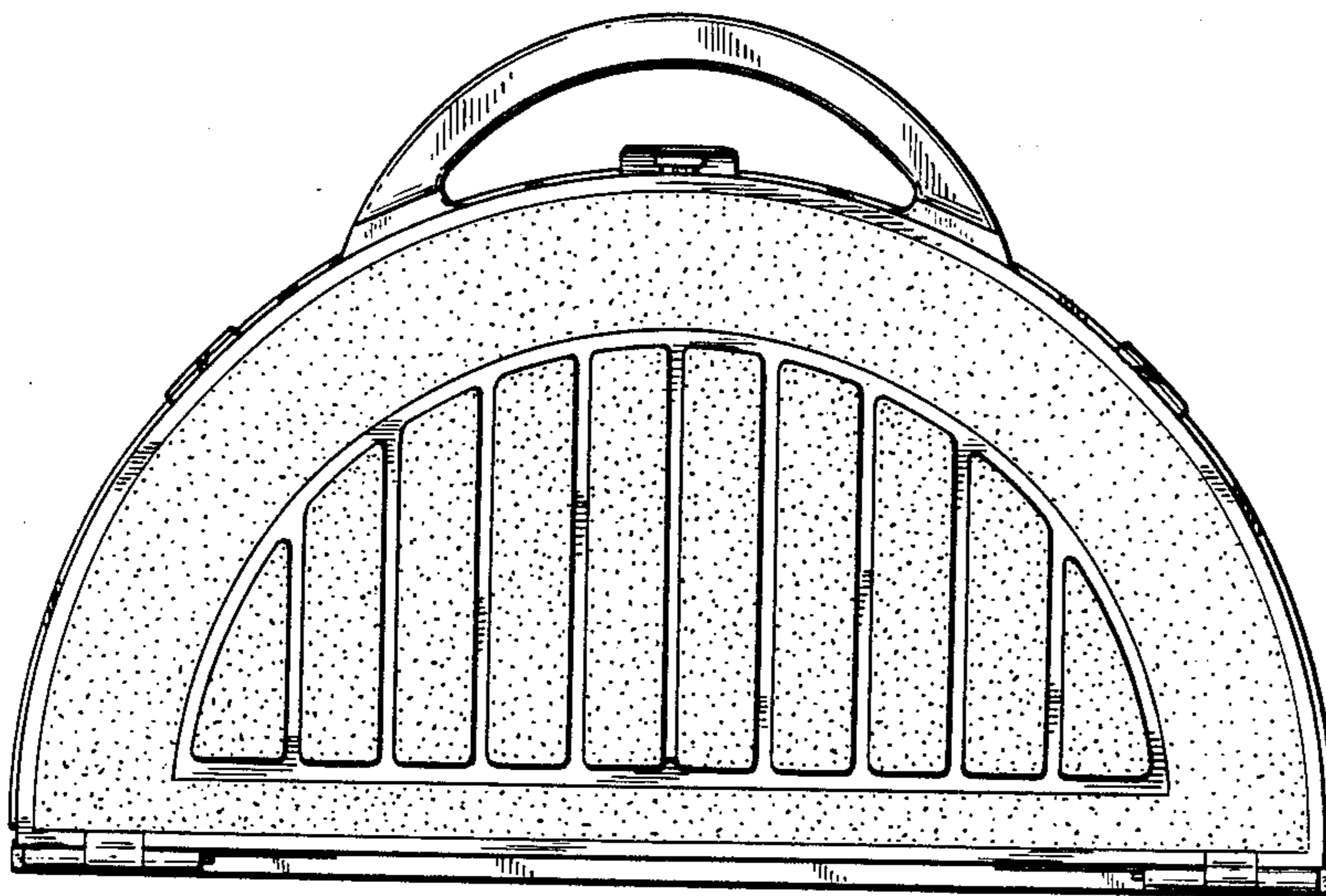

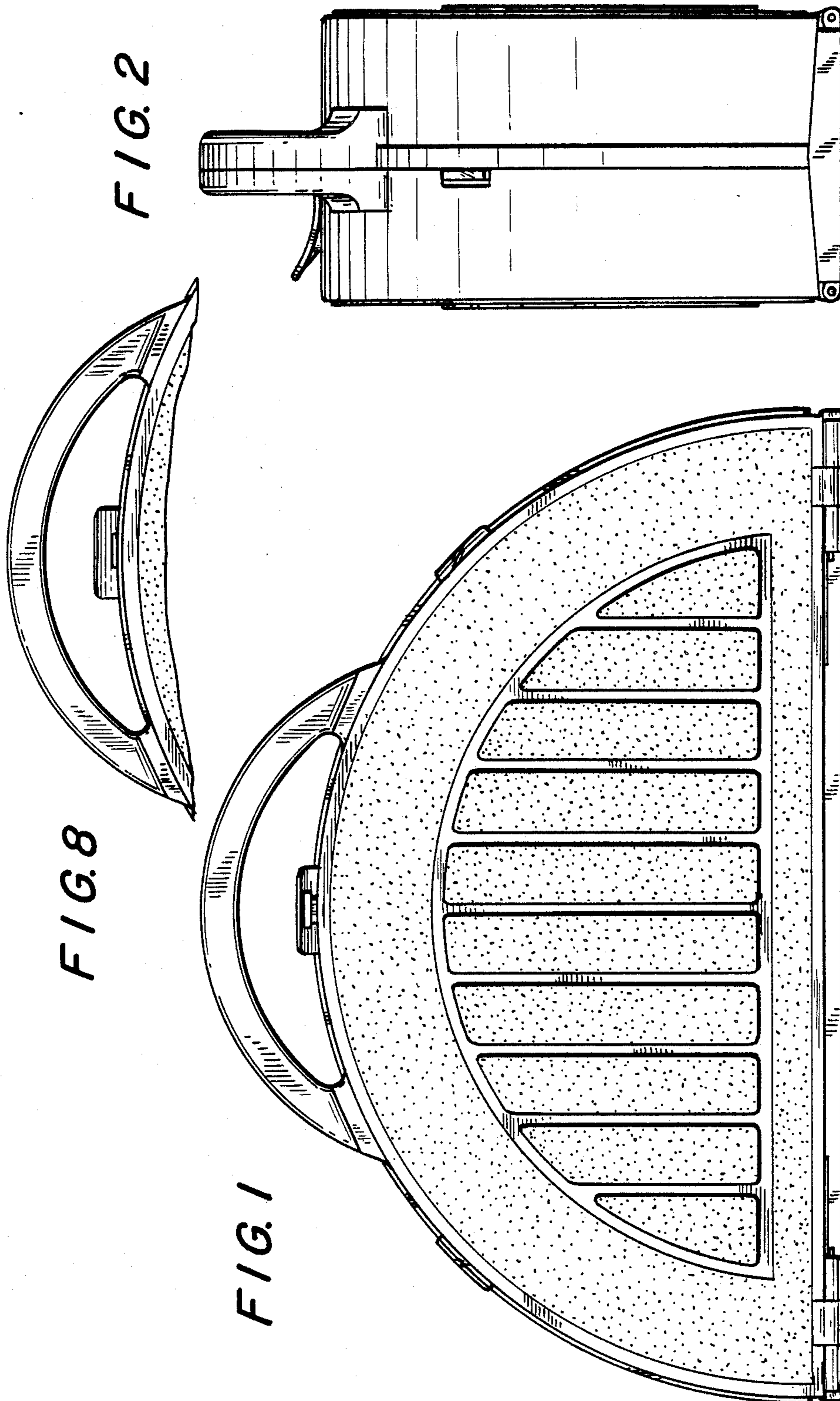

FIG. 2

FIG. 8

FIG. 1

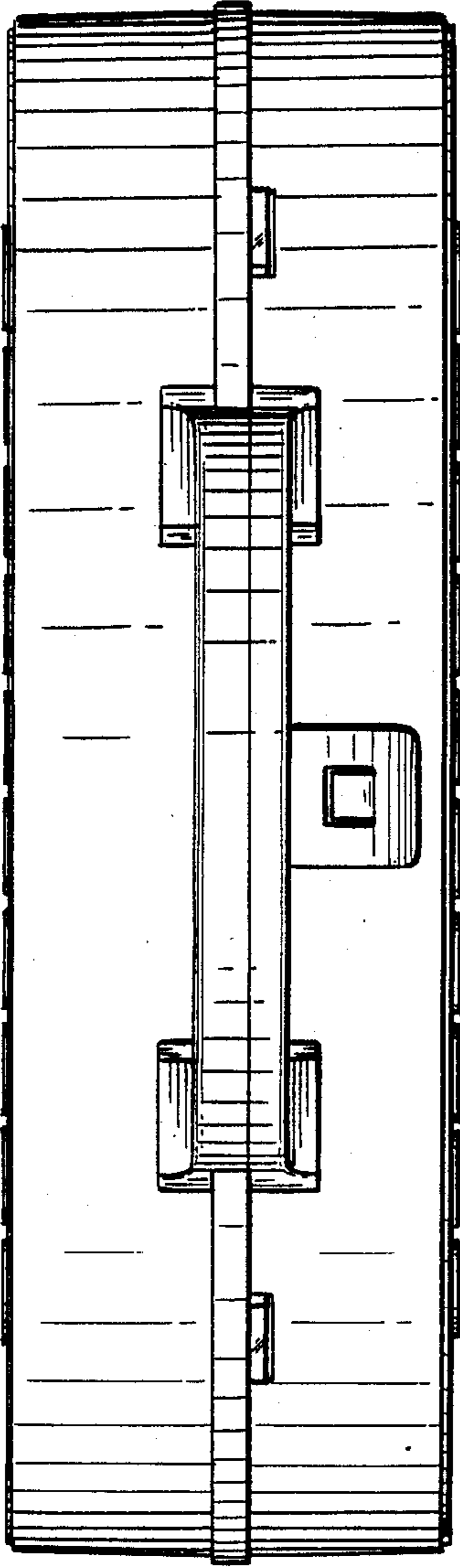

FIG. 3

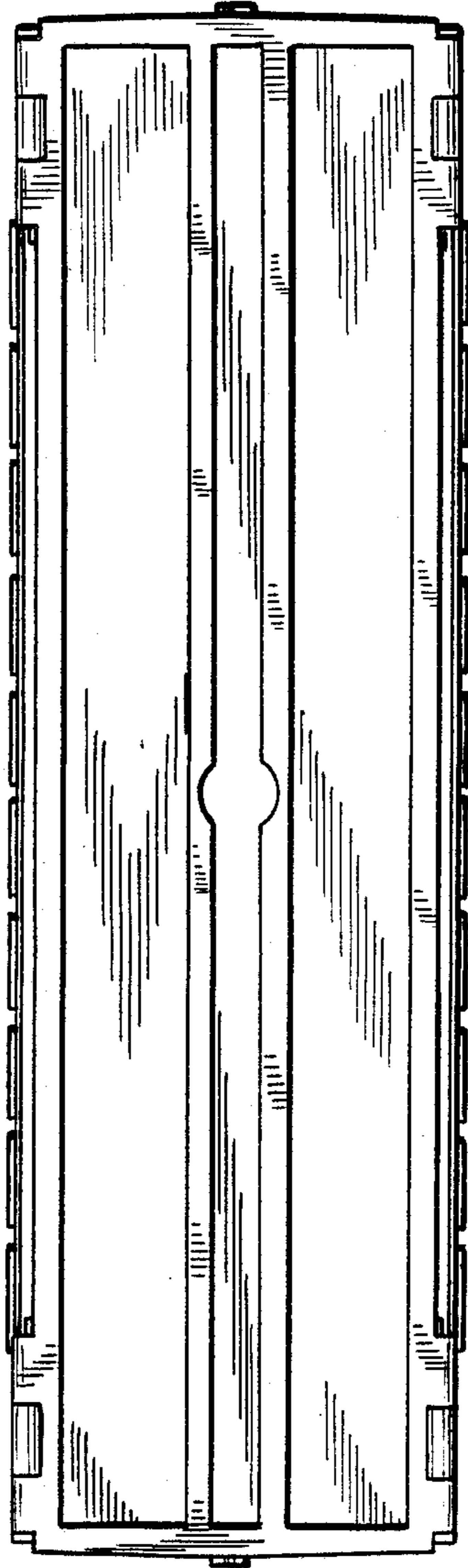

FIG. 4

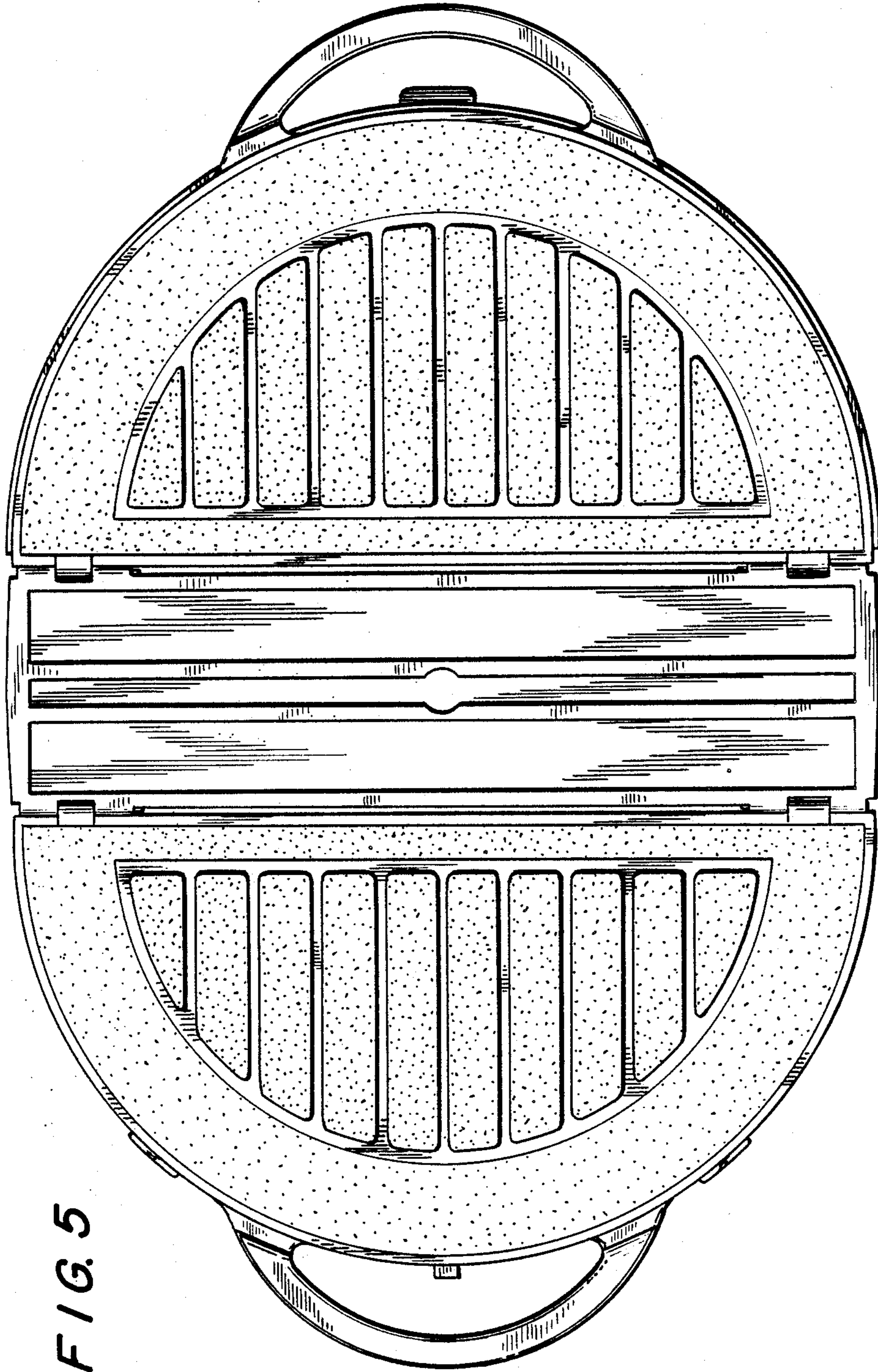

FIG. 5

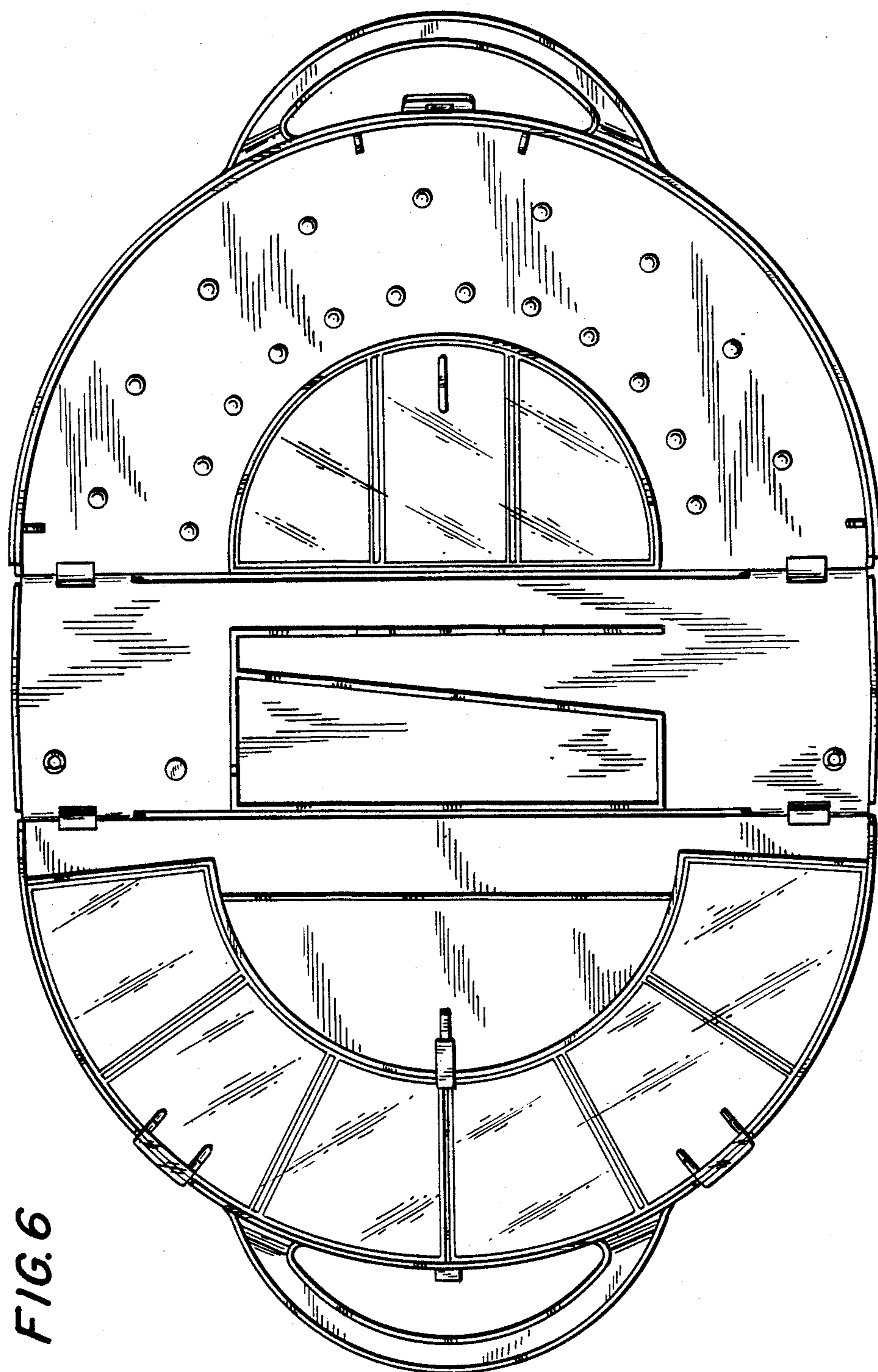

FIG. 6

FIG. 7

