

[54] SANDBOX

[75] Inventor: James F. Mariol, Cincinnati, Ohio

[73] Assignee: The Little Tikes Company, Hudson, Ohio

[**] Term: 14 Years

[21] Appl. No.: 39,527

[22] Filed: Apr. 17, 1987

[52] U.S. Cl. D21/252

[58] Field of Search D21/252, 154-155; D23/277-282, 285; D25/2; D24/37; D6/524-536; 272/1 A, 1 R, 56.5 R; 446/70; 4/488

[56] References Cited

U.S. PATENT DOCUMENTS

D. 111,328	2/1938	Sanford	D6/536
D. 254,988	5/1980	Jones et al.	D25/2 X
D. 258,463	3/1981	Emmer	D25/2
D. 260,288	8/1981	D'Innocente et al.	D23/277 X
D. 267,271	12/1982	Kingsley et al.	D25/2 X
D. 267,272	12/1982	Doman et al.	D23/277 X
D. 277,985	3/1985	Kingsley	D23/277 X
D. 279,702	7/1985	Harmson	D23/280
3,793,653	2/1974	Brooks	272/56.5 R X

FOREIGN PATENT DOCUMENTS

906062 9/1962 United Kingdom 446/70

Primary Examiner—Charles A. Rademaker
Assistant Examiner—C. Tuttle
Attorney, Agent, or Firm—Richard B. O'Planick

[57] CLAIM

The ornamental design for a sandbox, as shown and described.

DESCRIPTION

FIG. 1 is a top perspective view of a sandbox showing my new design;
FIG. 2 is a top plan view thereof;
FIG. 3 is a top plan view of the base of the sandbox shown separately for clarity of illustration;
FIG. 4 is a bottom plan view thereof;
FIG. 5 is a front elevational view of the lid component of the sandbox, the undisclosed rear portion being a mirror image of the side shown;
FIG. 6 is a side elevational view thereof, the undisclosed side being a mirror image of the side shown;
FIG. 7 is a front elevational view of the base component of the sandbox, the undisclosed rear portion being a mirror image of the side shown; and
FIG. 8 is a side elevational view thereof, the undisclosed side being a mirror image of the side shown.

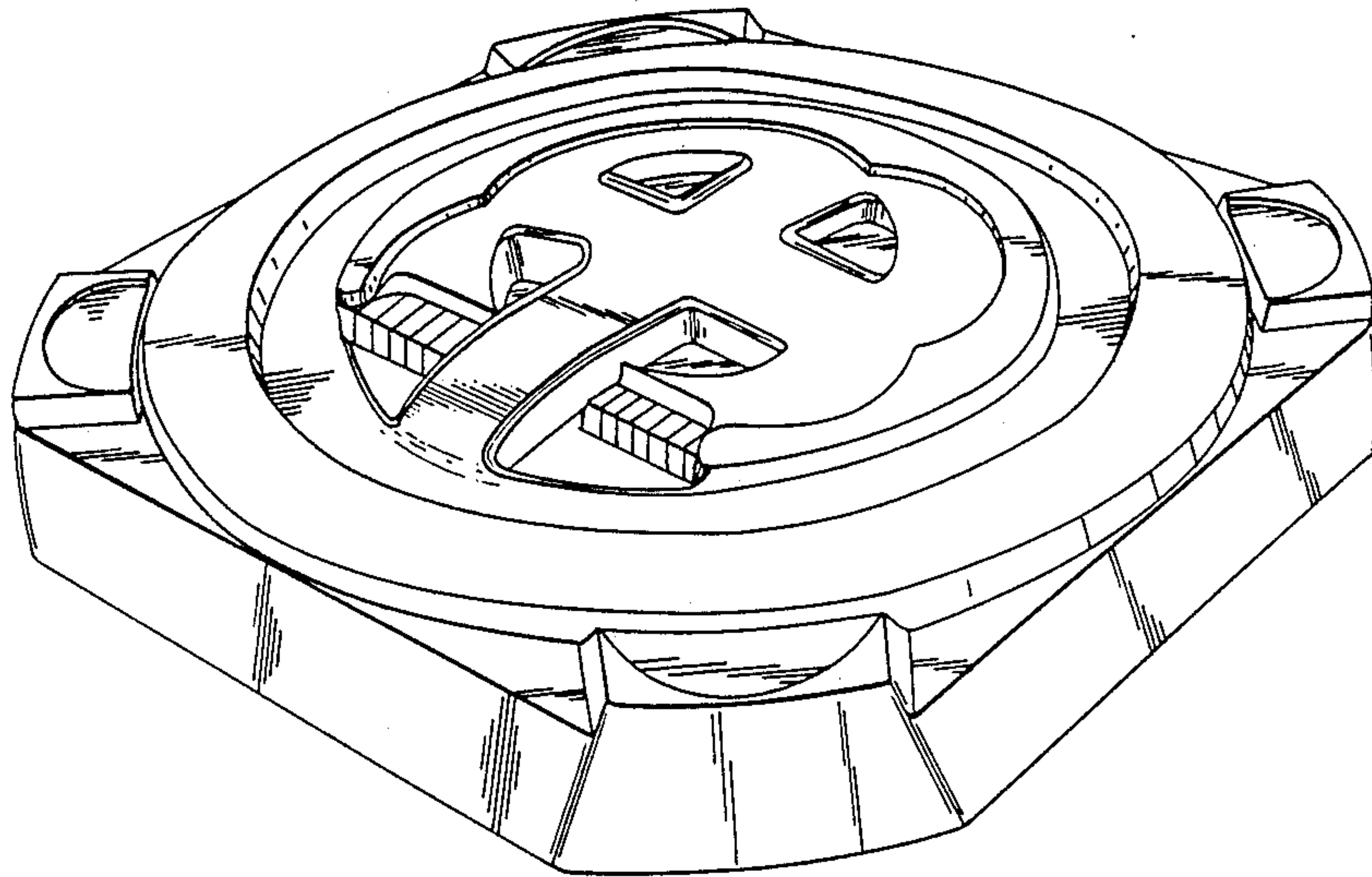

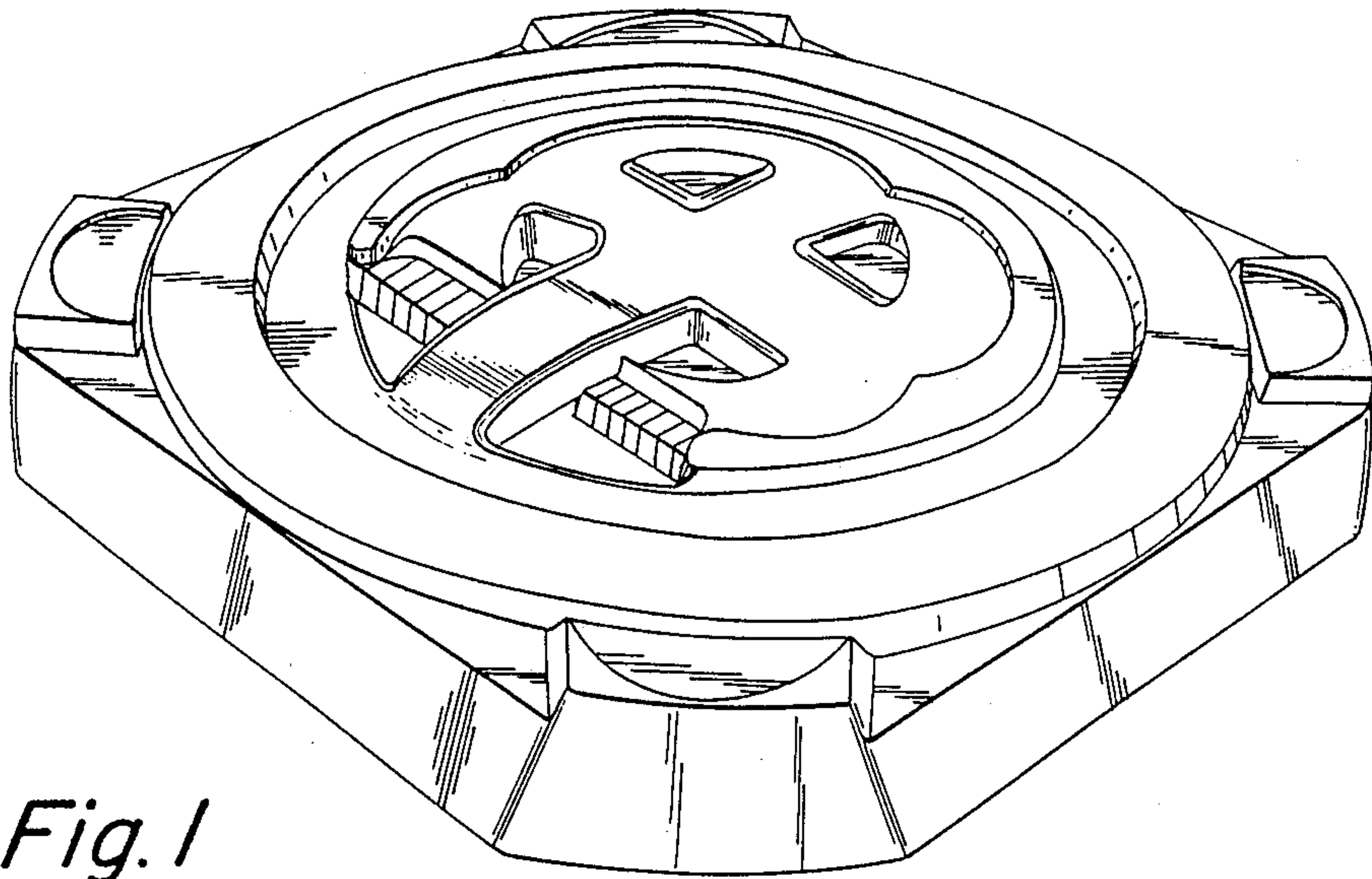

Fig. 1

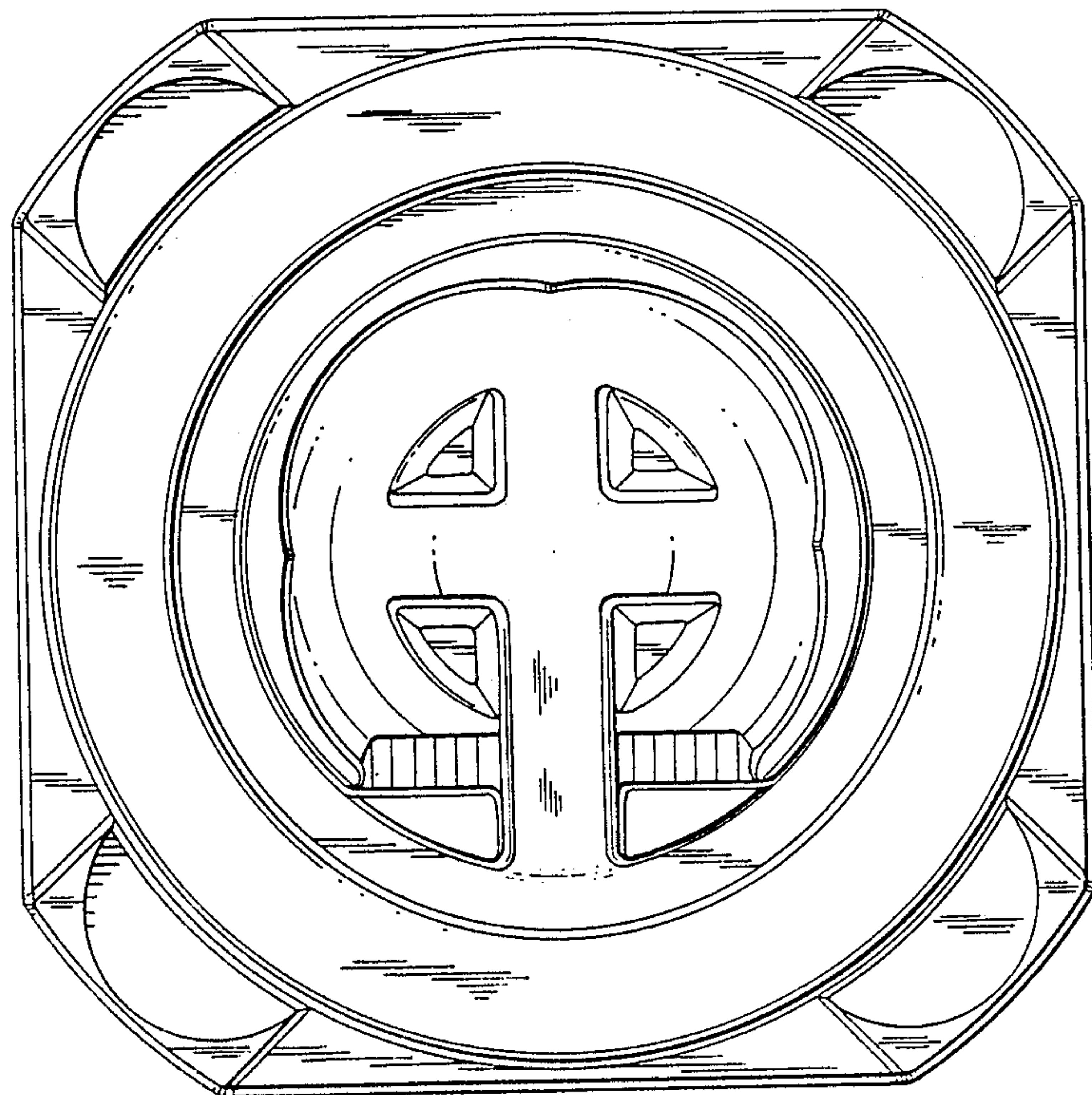

Fig. 2

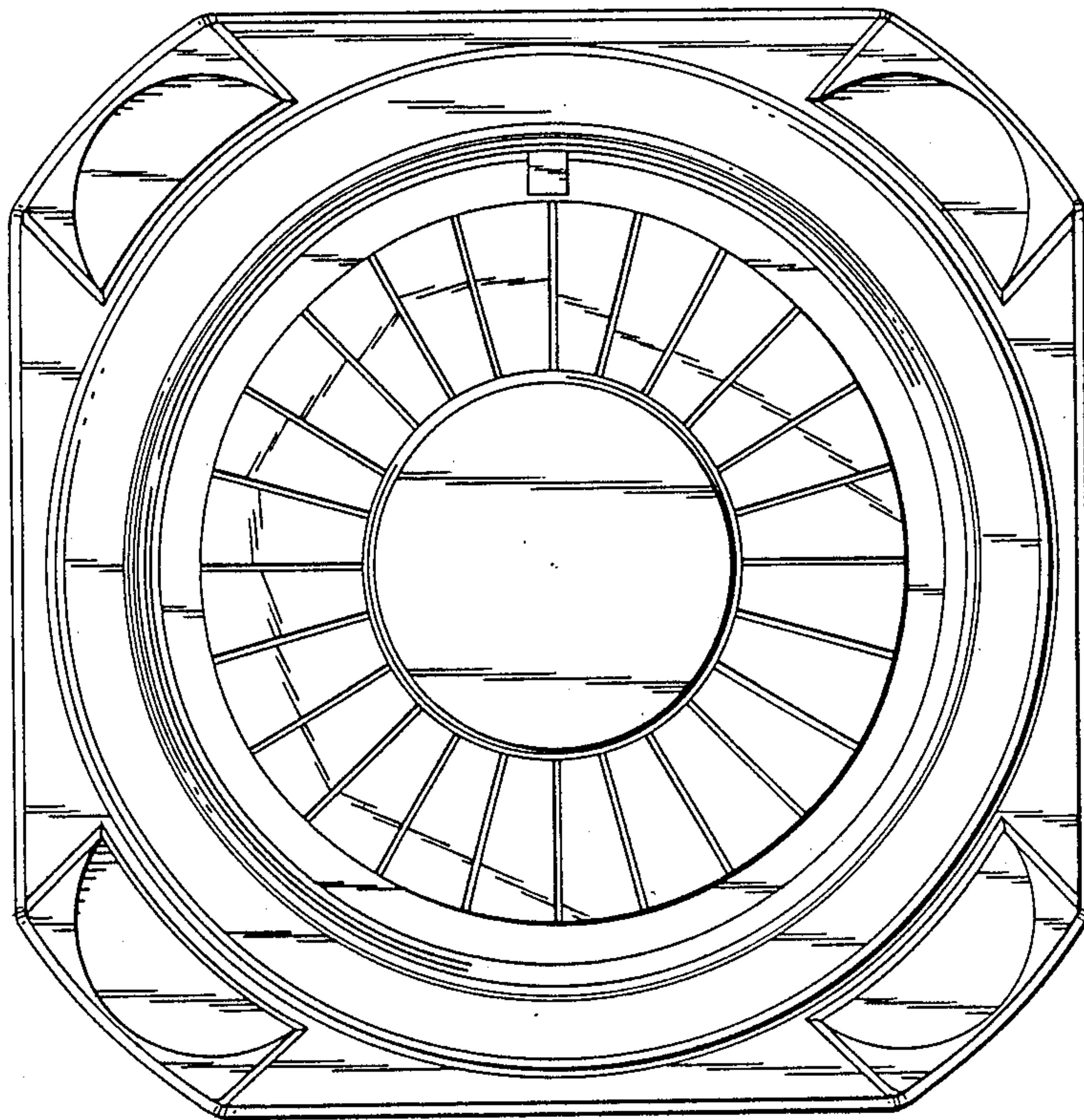

Fig. 3

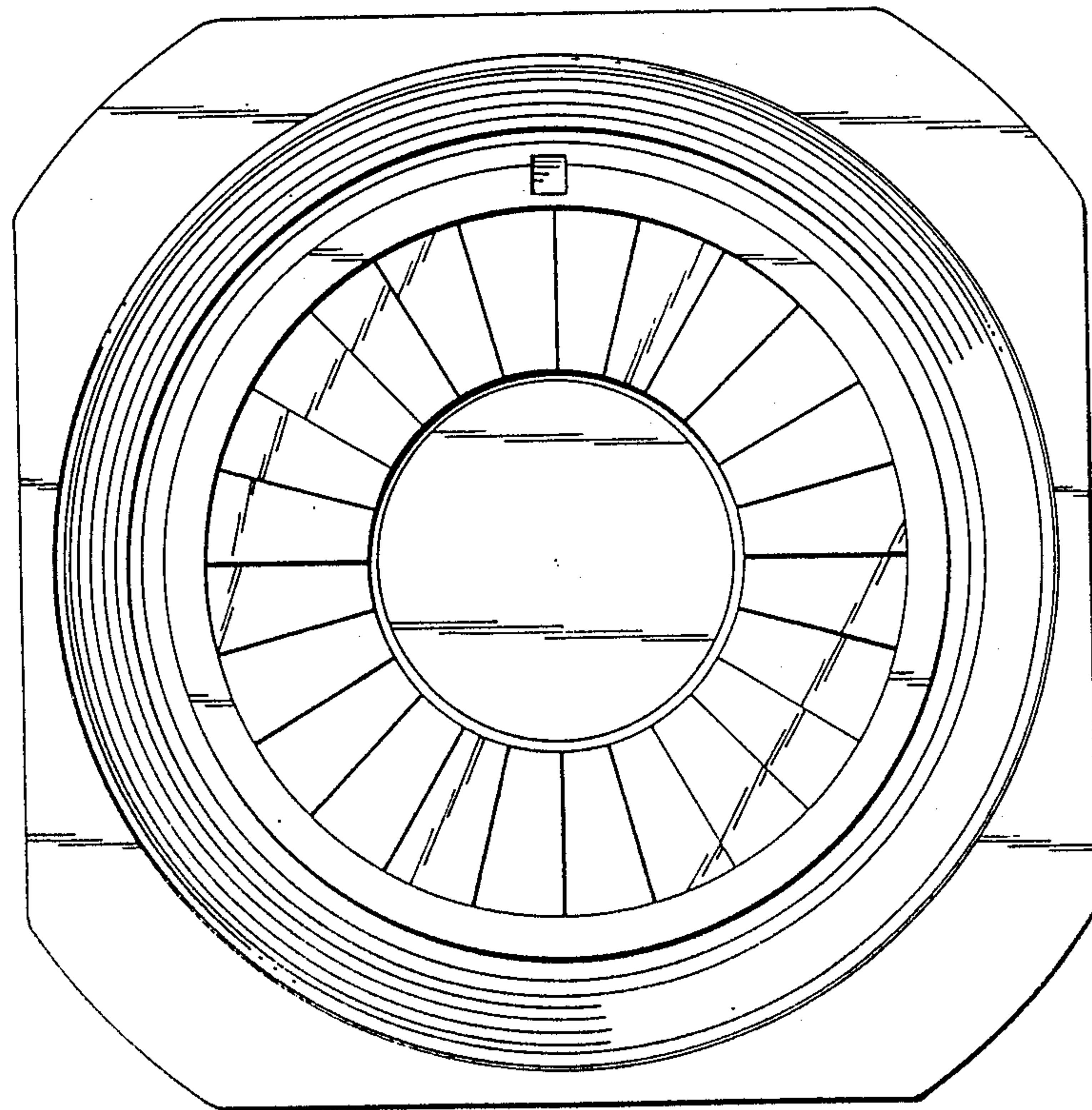

Fig. 4

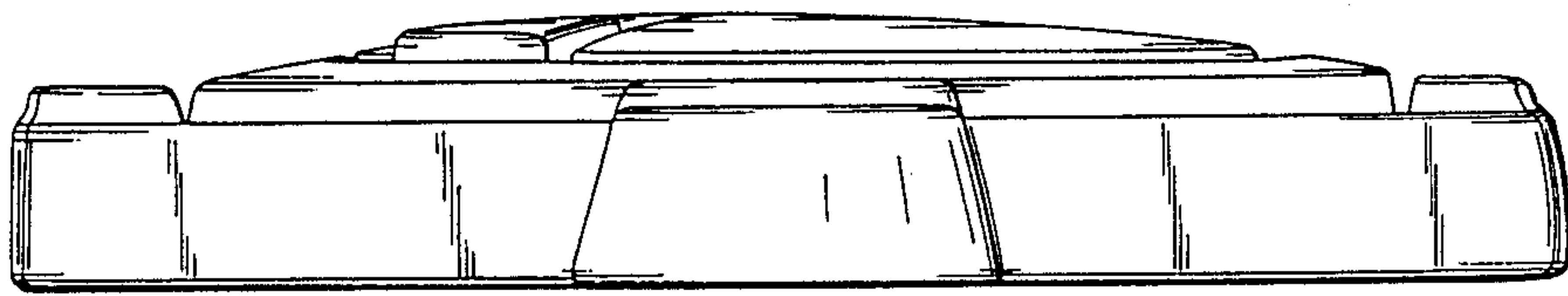

Fig. 5

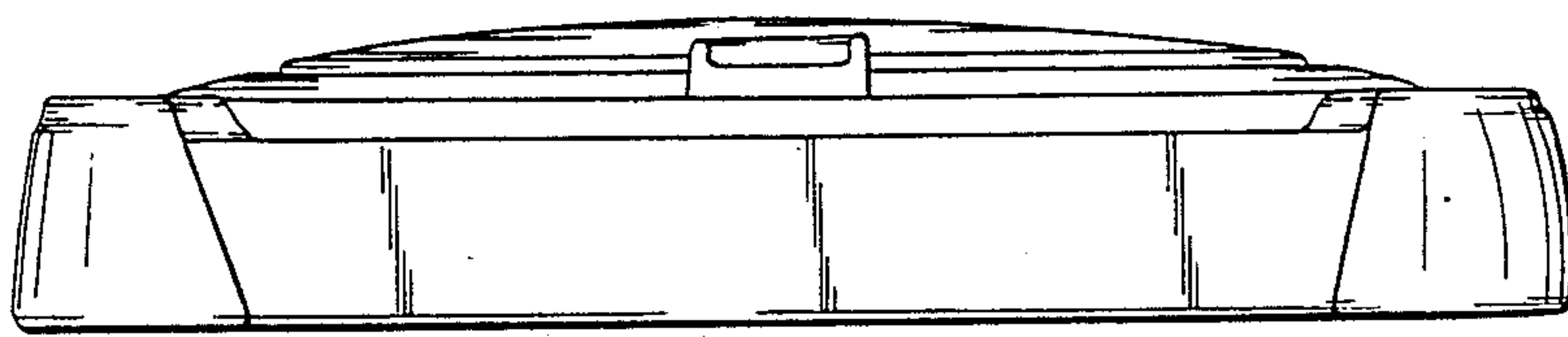

Fig. 6

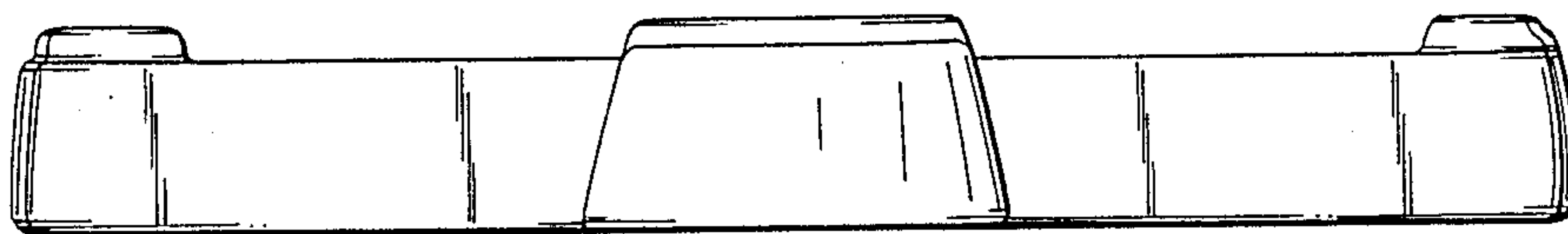

Fig. 7

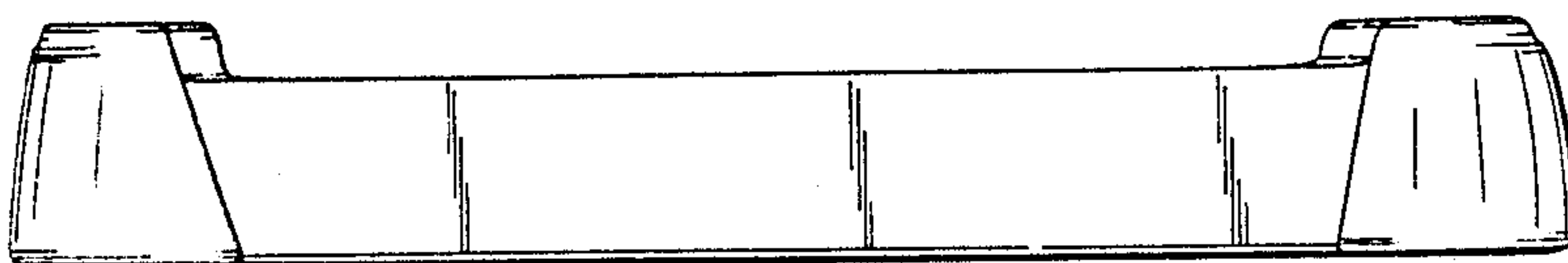

Fig. 8