

[54] **GREETING CARD**

[76] **Inventor: William P. Warkentin, 14 Turner Crescent, St. Catharines, Ontario, Canada, L2P 2H6**

[**] **Term: 14 Years**

[21] **Appl. No.: 114,255**

[22] **Filed: Oct. 26, 1987**

[30] **Foreign Application Priority Data**

Apr. 27, 1987 [CA] Canada 27-04-87-6
[52] **U.S. Cl.** **D19/1**
[58] **Field of Search** D19/1, 2, 6, 7; D21/59;
446/220, 147; 229/6 R, 92.8, 103, 9; 40/124,
124.1

[56] **References Cited**
U.S. PATENT DOCUMENTS

D. 203,011 11/1965 Heller et al. D19/2
1,379,739 5/1921 Bennett 40/124.1
2,110,784 3/1938 Wolfson 446/147 X
4,062,138 12/1977 Warenback 40/124.1

Primary Examiner—Wallace R. Burke
Assistant Examiner—Pamela J. Schmidt
Attorney, Agent, or Firm—Arne I. Fors

[57] **CLAIM**

The ornamental design for a greeting card, as shown and described.

DESCRIPTION

FIG. 1 is a front perspective view of a greeting card showing my new design;
FIG. 2 is a left side elevational view thereof;
FIG. 3 is a rear elevational view thereof;
FIG. 4 is a bottom plan view thereof;
FIG. 5 is a top plan view thereof, in partially collapsed condition.

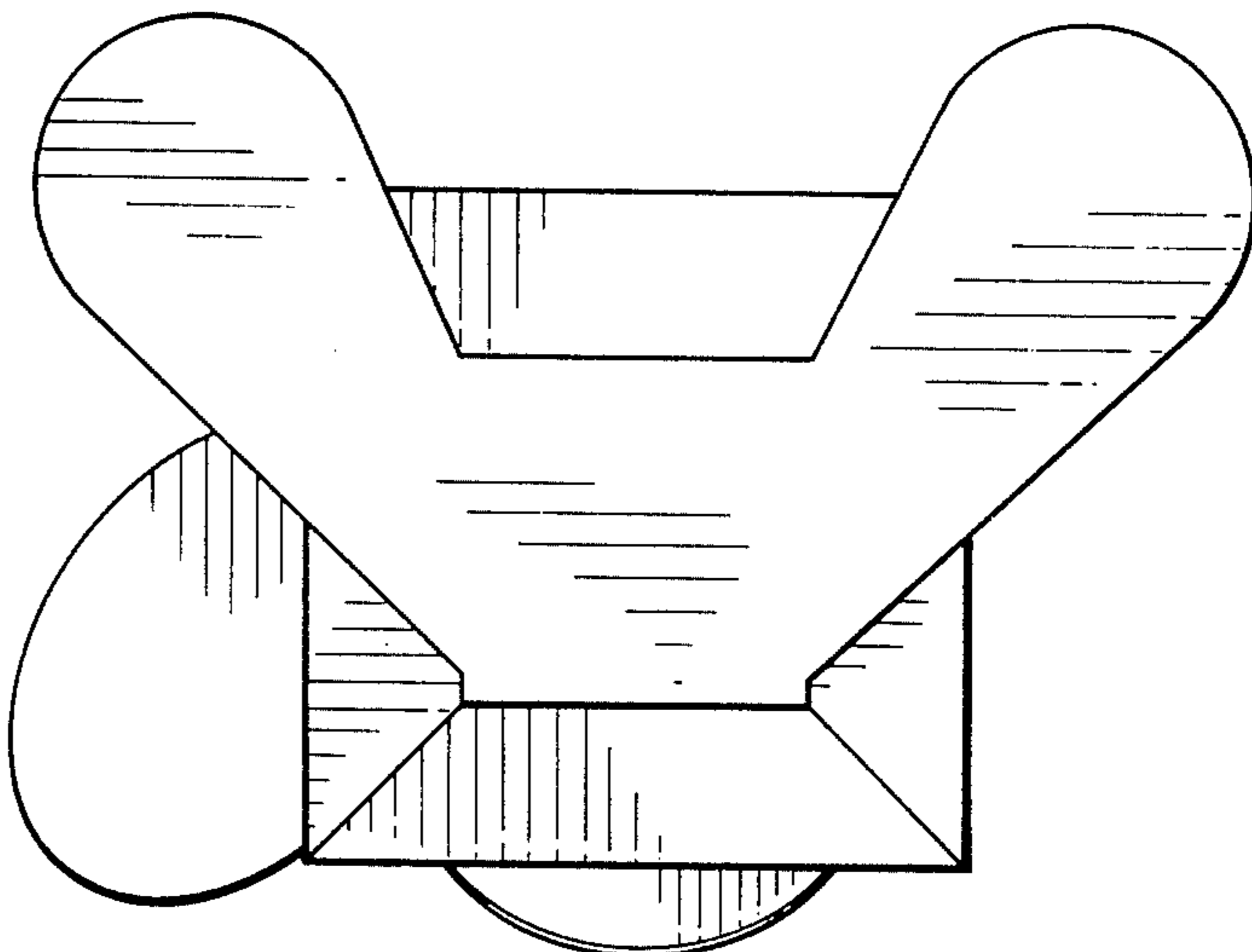
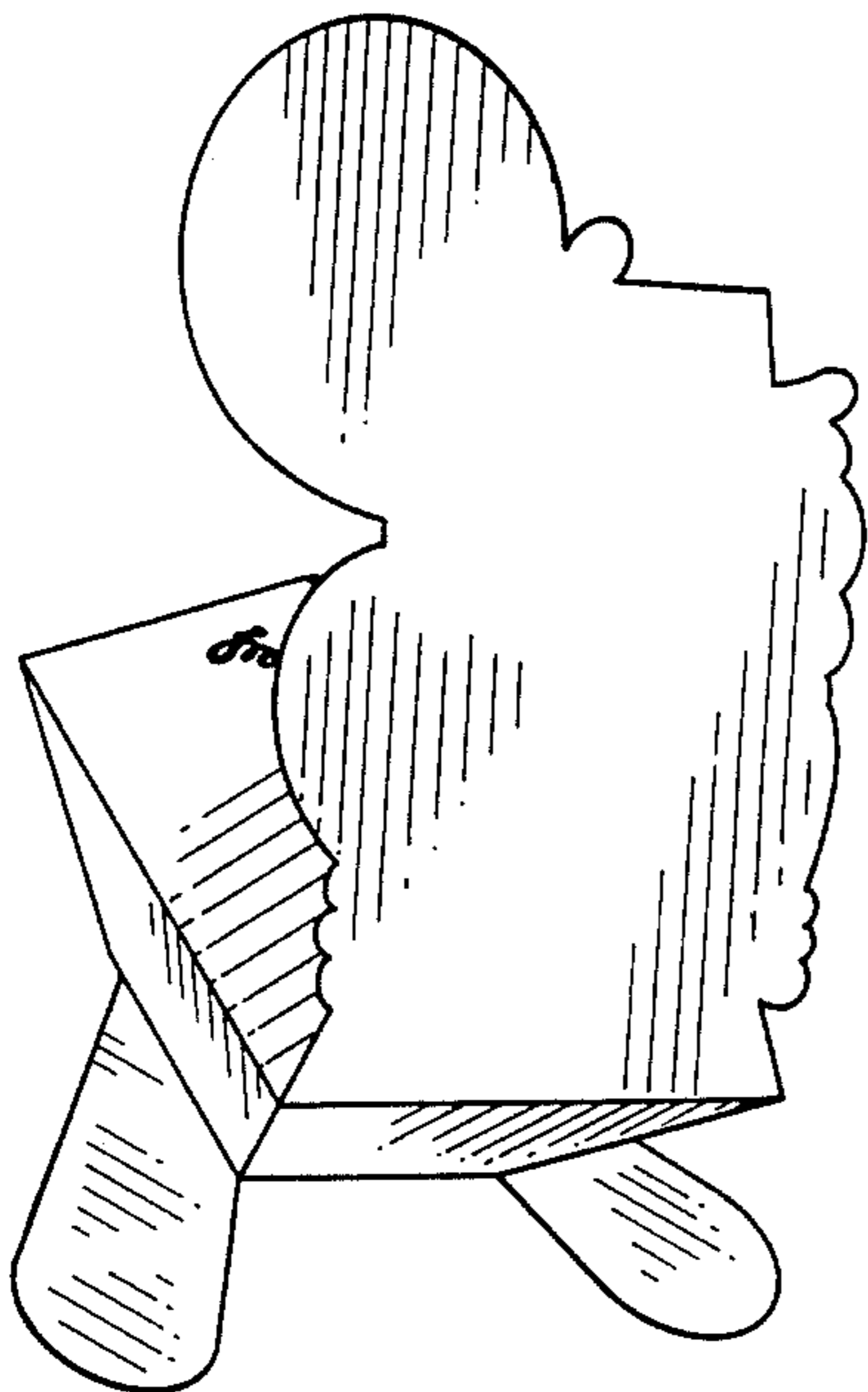

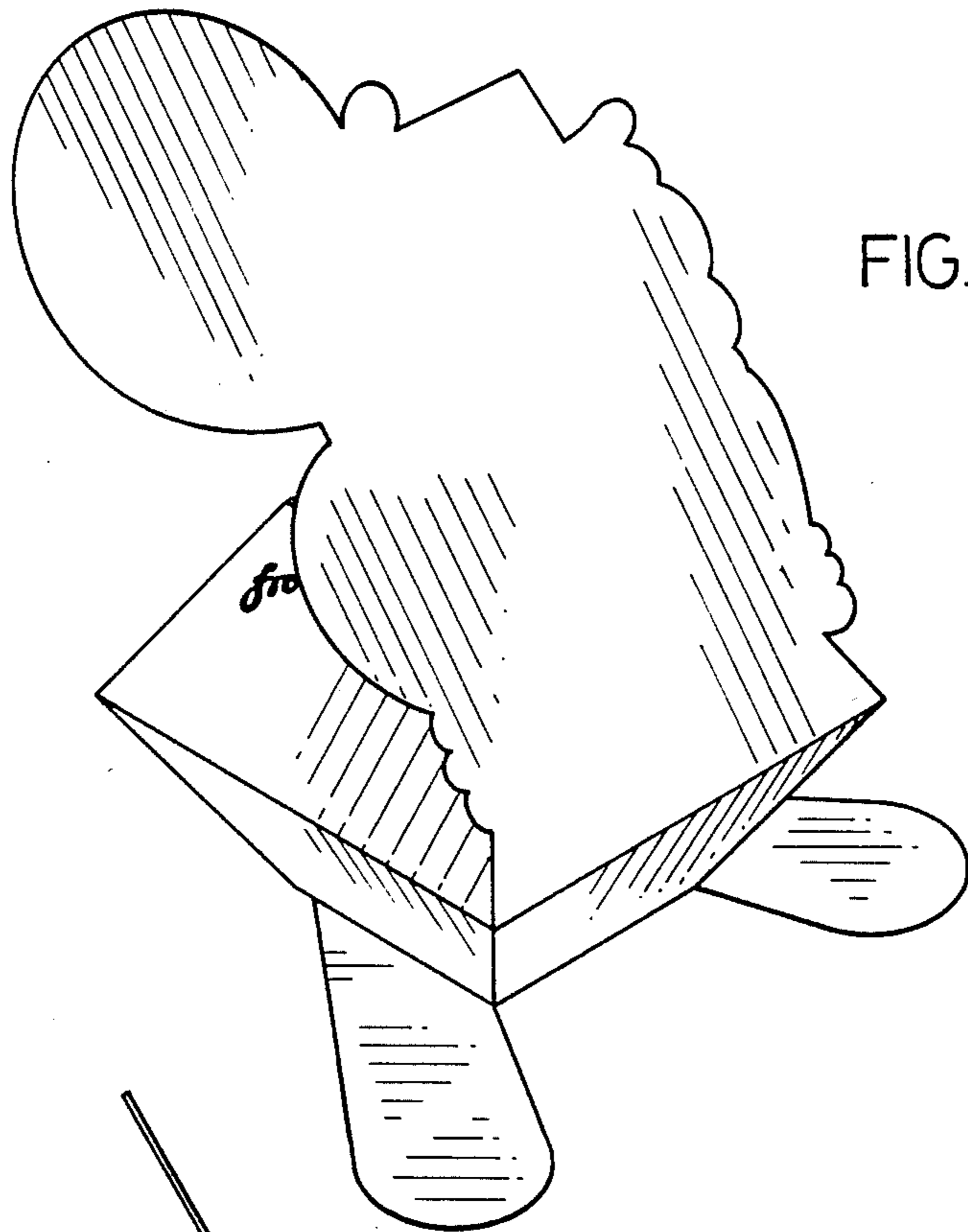

FIG.1.

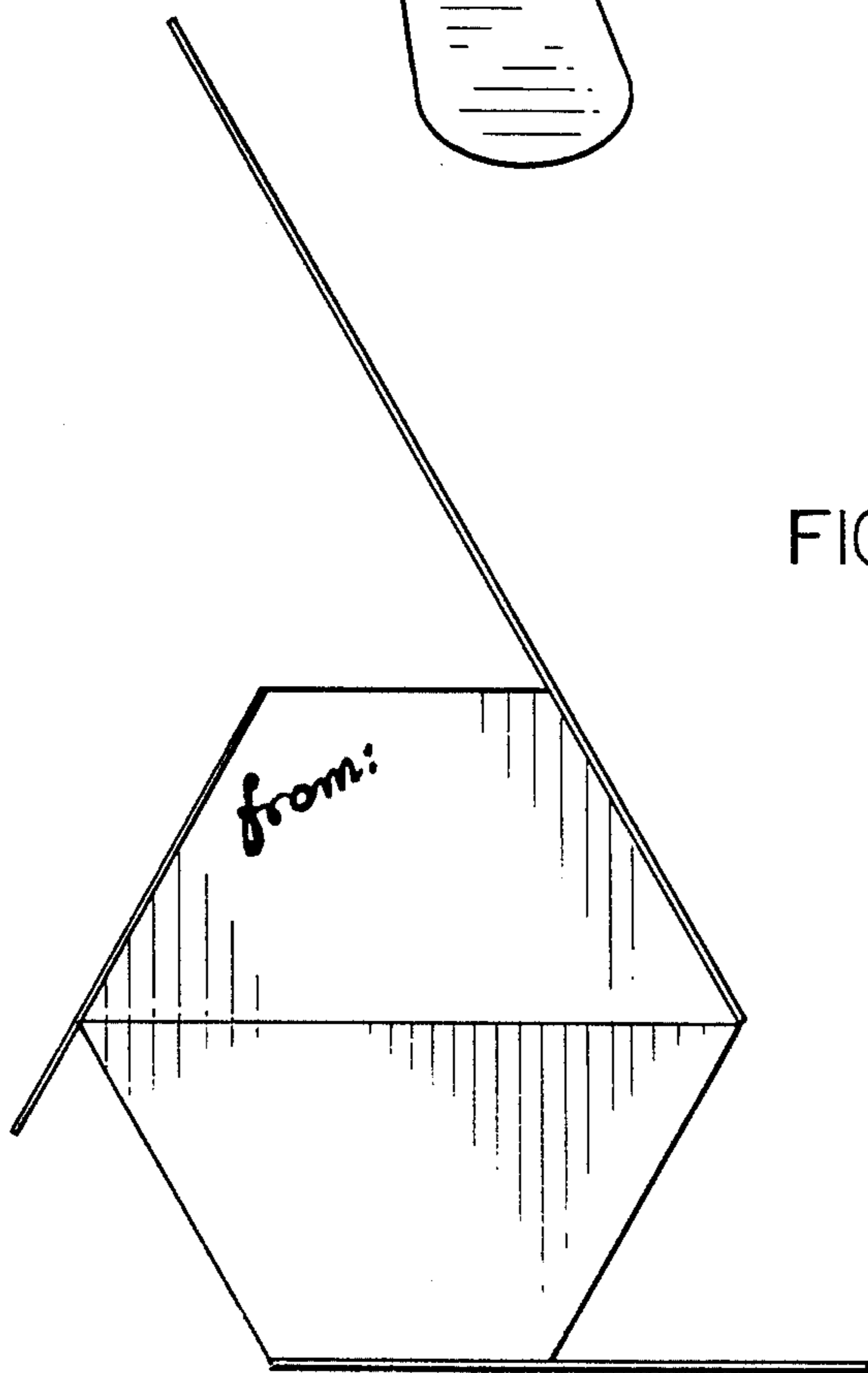

FIG.2.

FIG.3.

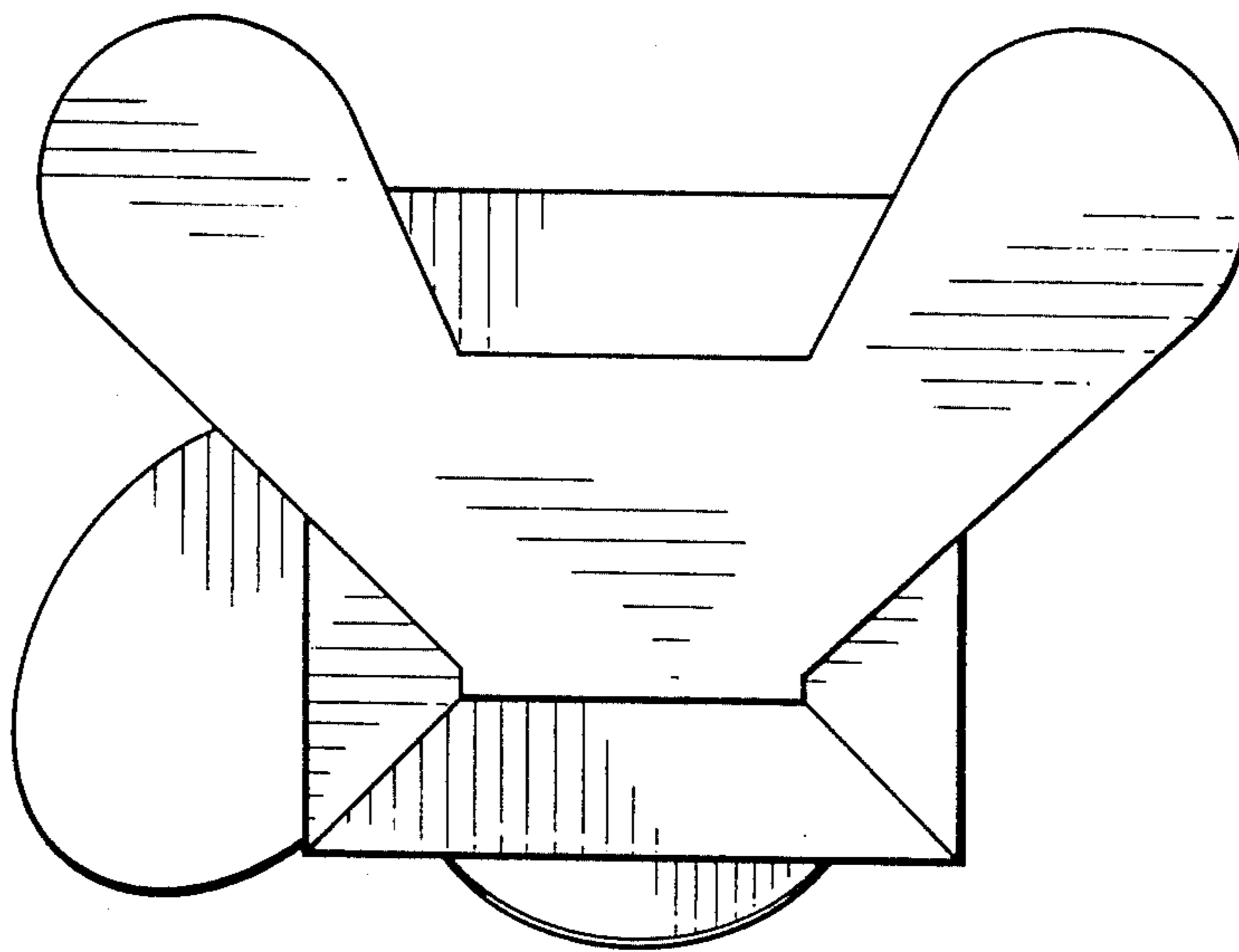
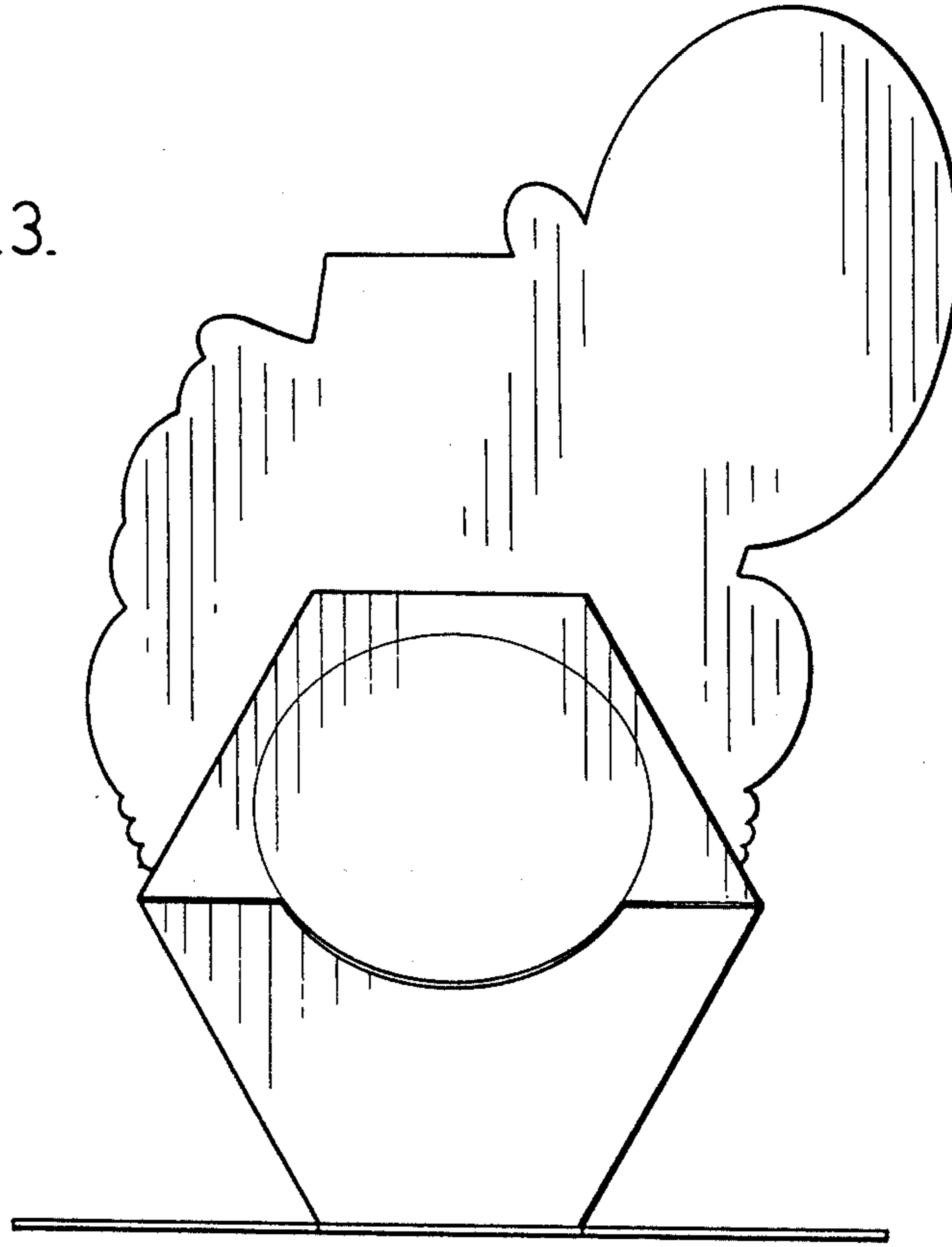

FIG.4.

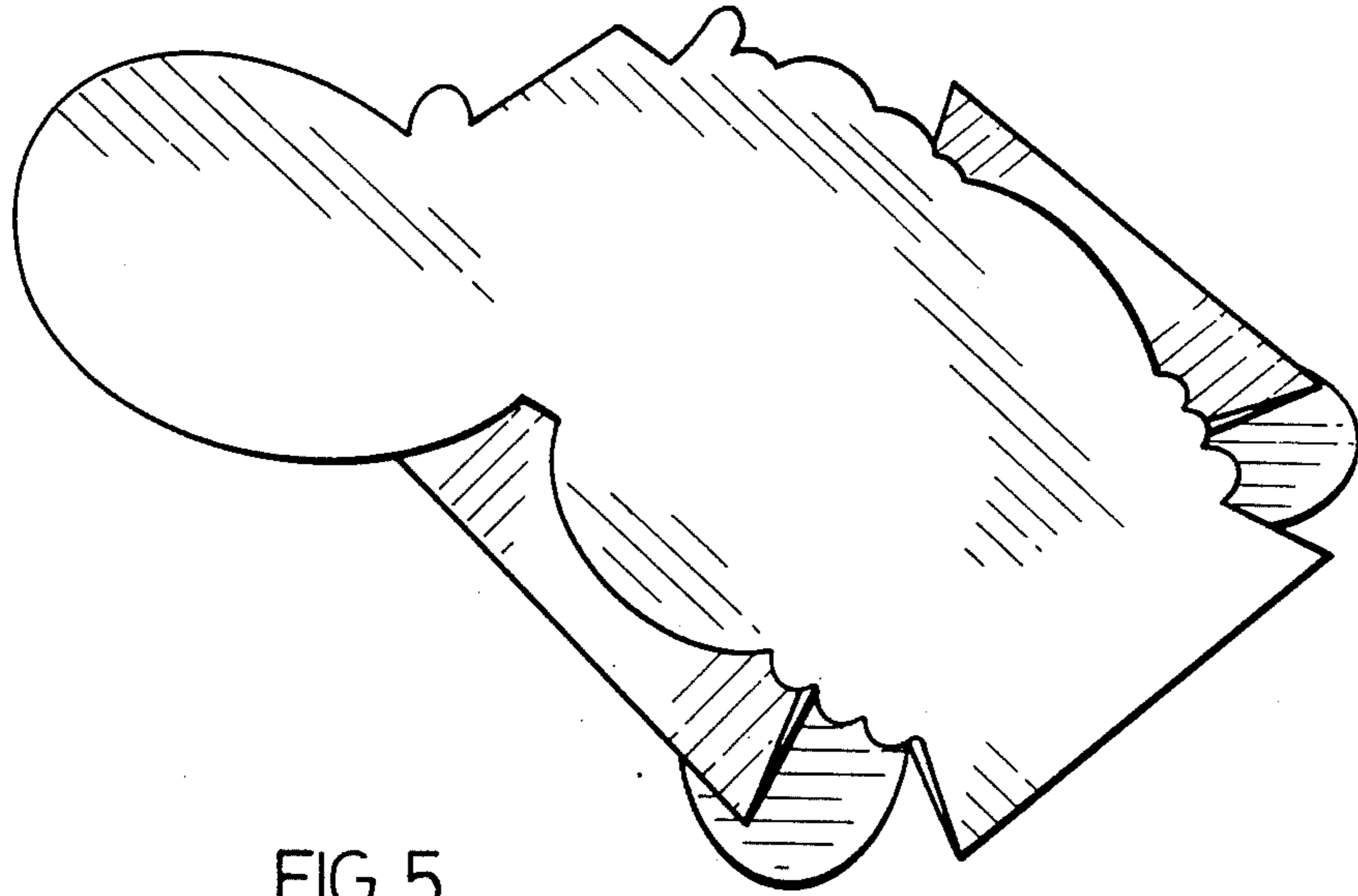

FIG. 5.