

[54] WOODWIND MOUTHPIECE

[76] Inventor: William P. Disera, 555 Westminster St., Joliet, Ill. 60435

[**] Term: 14 Years

[21] Appl. No.: 38,343

[22] Filed: Apr. 14, 1987

[52] U.S. Cl. D17/13; 84/383 R

[58] Field of Search D17/13; 84/383 R

[56] References Cited

U.S. PATENT DOCUMENTS

D. 146,547	4/1947	Thompson	D17/13
D. 162,406	3/1951	Grossman	D17/13
2,517,077	8/1950	Berry	84/383
2,525,523	10/1950	Chance	84/383
3,094,891	6/1963	Brilhart	84/383
4,041,827	8/1977	Daglis	84/383 R

Primary Examiner—Bernard Ansher
Assistant Examiner—Adir Aronovich
Attorney, Agent, or Firm—Willian Brinks Olds Hofer
Gilson & Lione

[57] CLAIM

The ornamental design for a woodwind mouthpiece, as shown and described.

DESCRIPTION

FIG. 1 is a perspective view of a woodwind mouthpiece showing my new design;
FIG. 2 is a top plan view thereof;
FIG. 3 is a left side elevational view thereof;
FIG. 4 is a front elevational view thereof;
FIG. 5 is a right side elevational view;
FIG. 6 is a bottom plan view thereof;
FIG. 7 is a cross-sectional view of the mouthpiece taken along the line 7—7 in FIG. 2;
FIG. 8 is a perspective view of a modified woodwind mouthpiece shown in FIG. 1;
FIG. 9 is a top plan view thereof;
FIG. 10 is a left side elevational view thereof;
FIG. 11 is a front elevational view thereof;
FIG. 12 is a right side elevational view thereof;
FIG. 13 is a bottom plan view thereof; and
FIG. 14 is a cross-sectional view of the mouthpiece taken along the line 14—14 in FIG. 9.

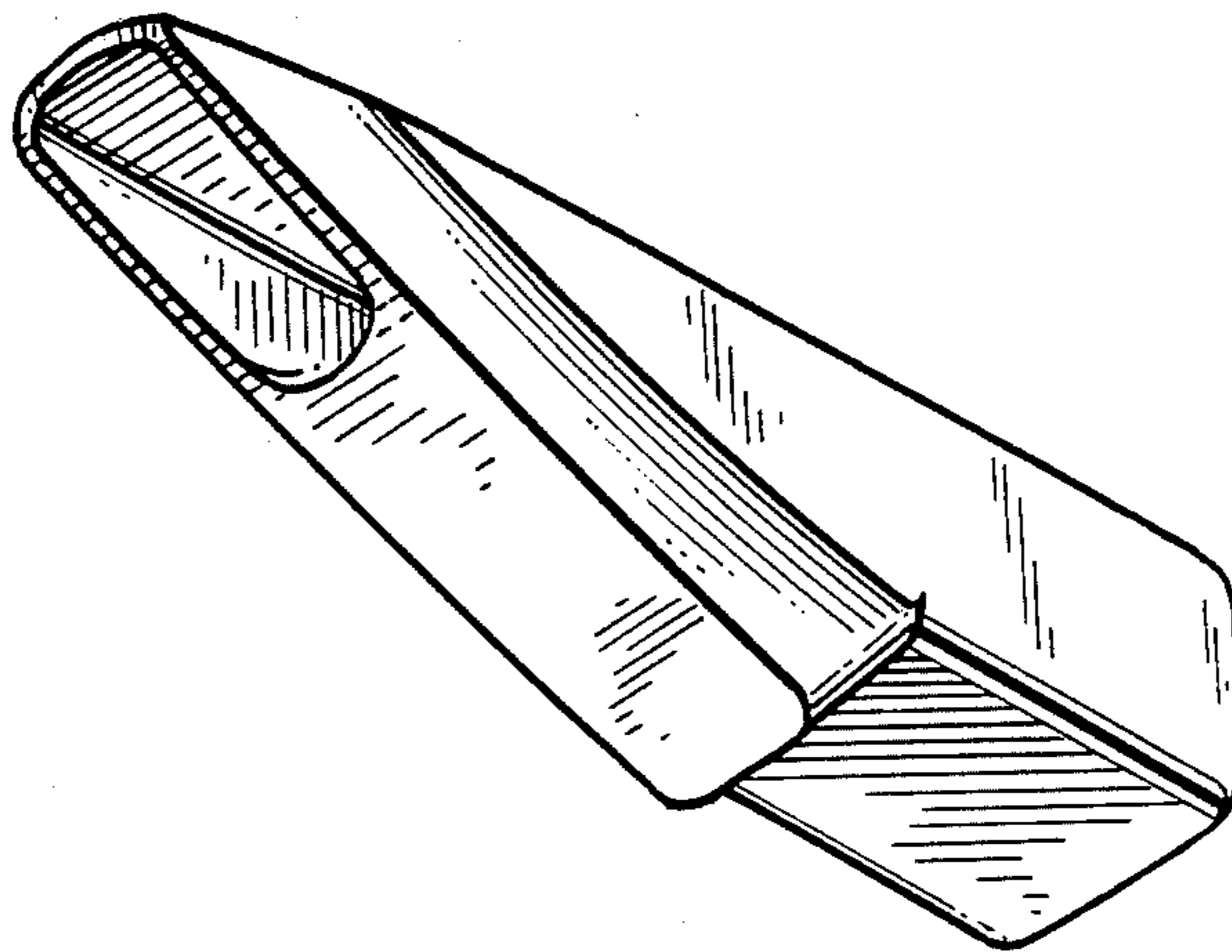

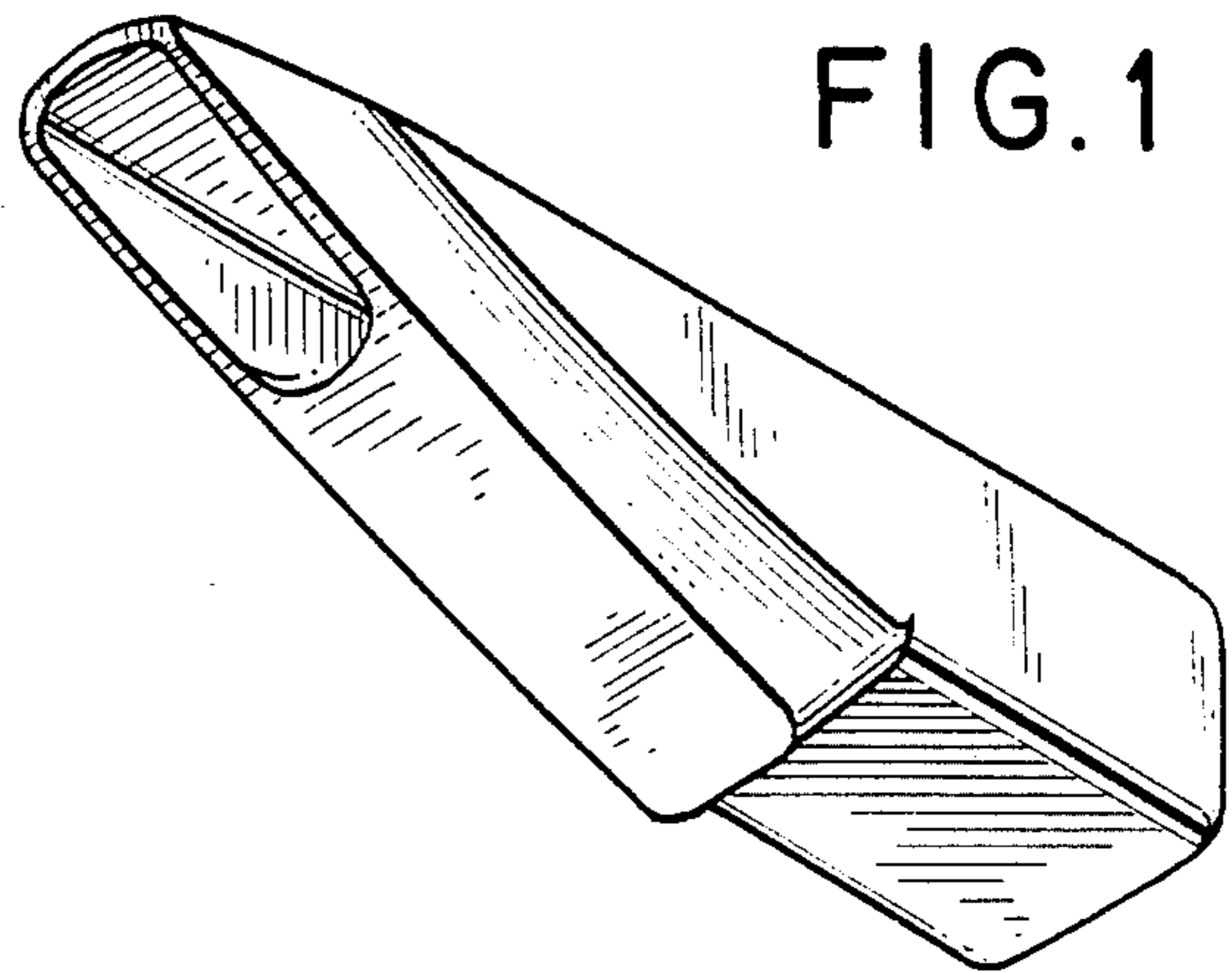

FIG. 1

FIG. 7

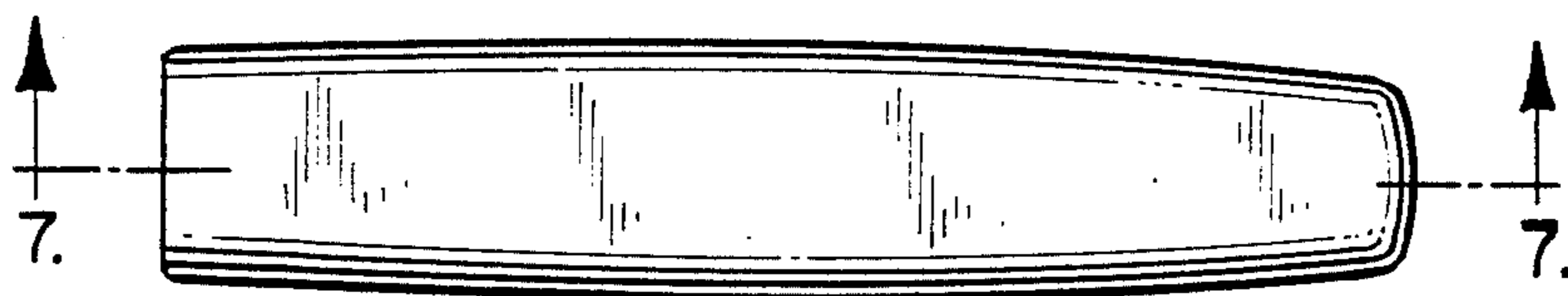
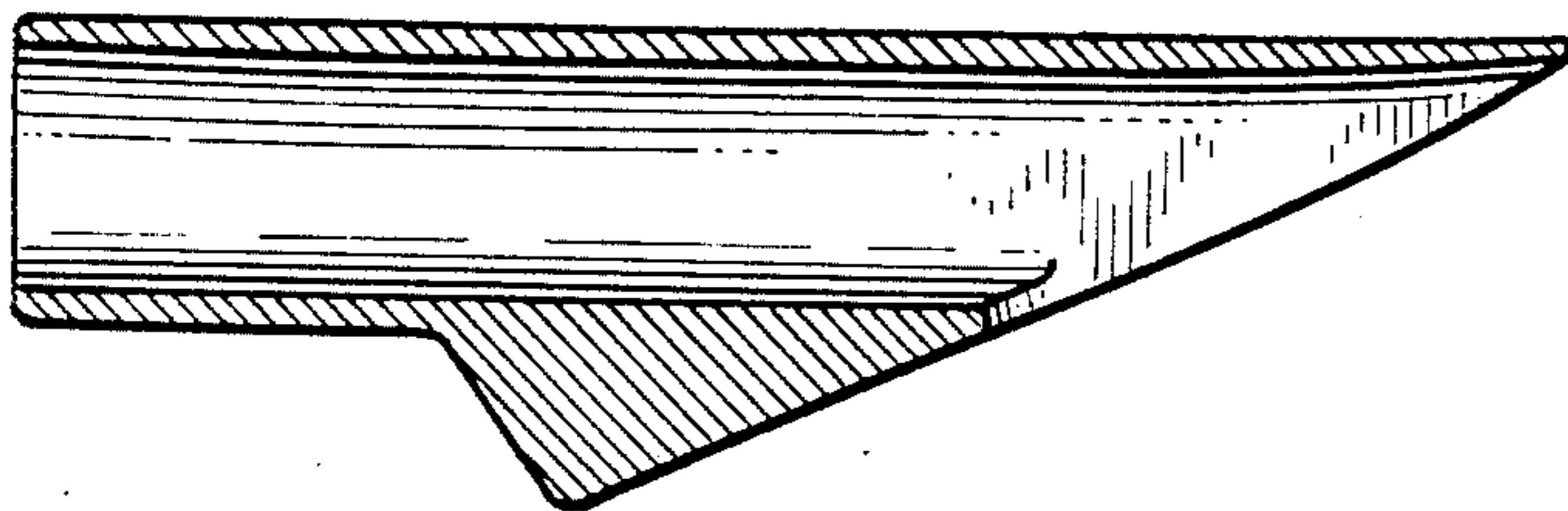

FIG. 2

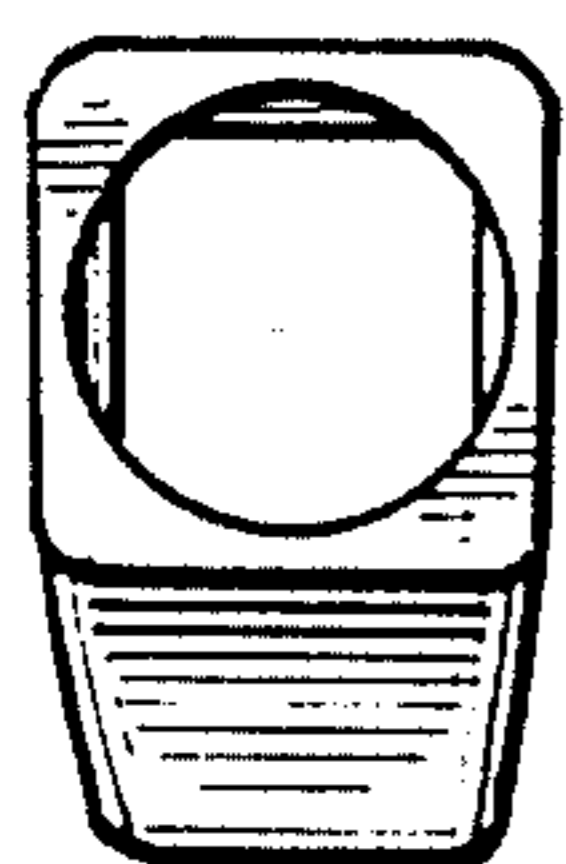

FIG. 3

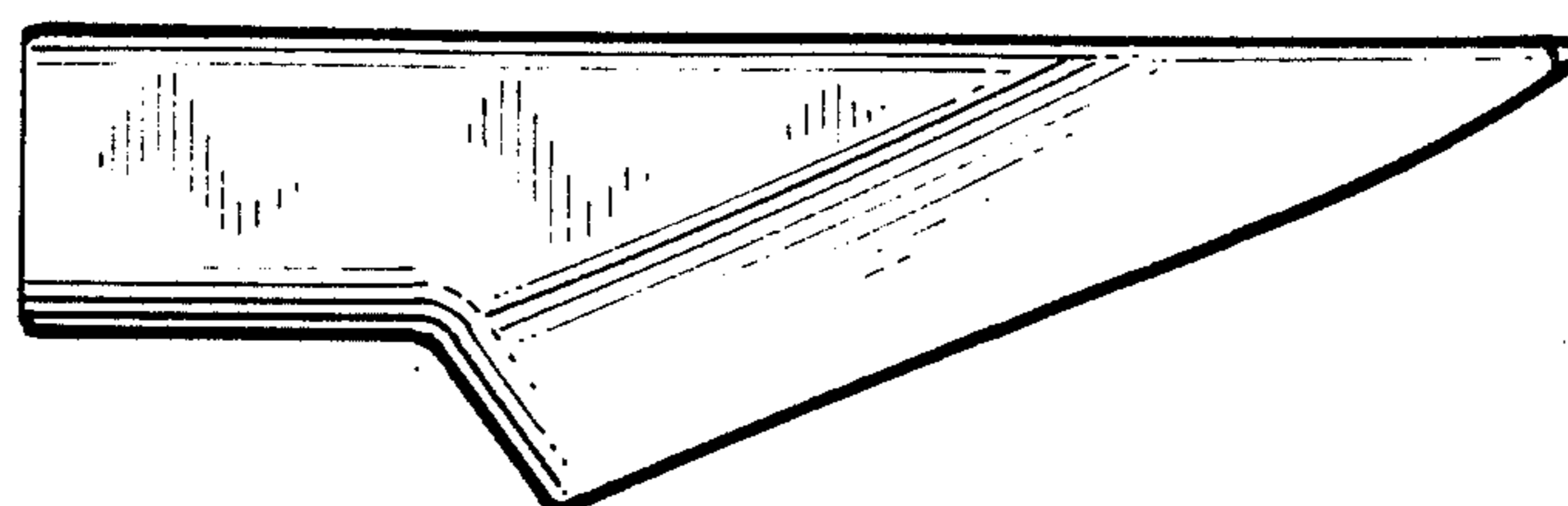

FIG. 4

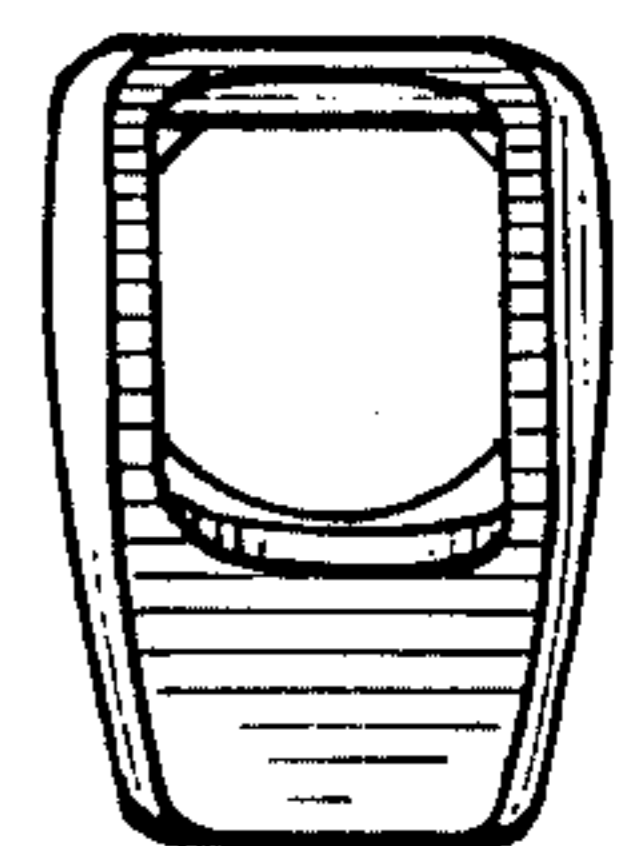

FIG. 5

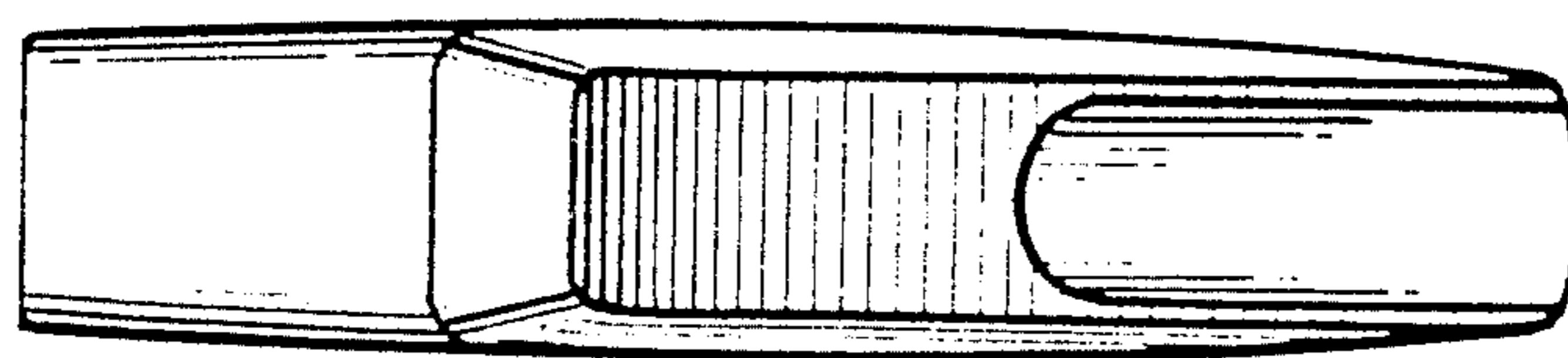

FIG. 6

FIG. 8

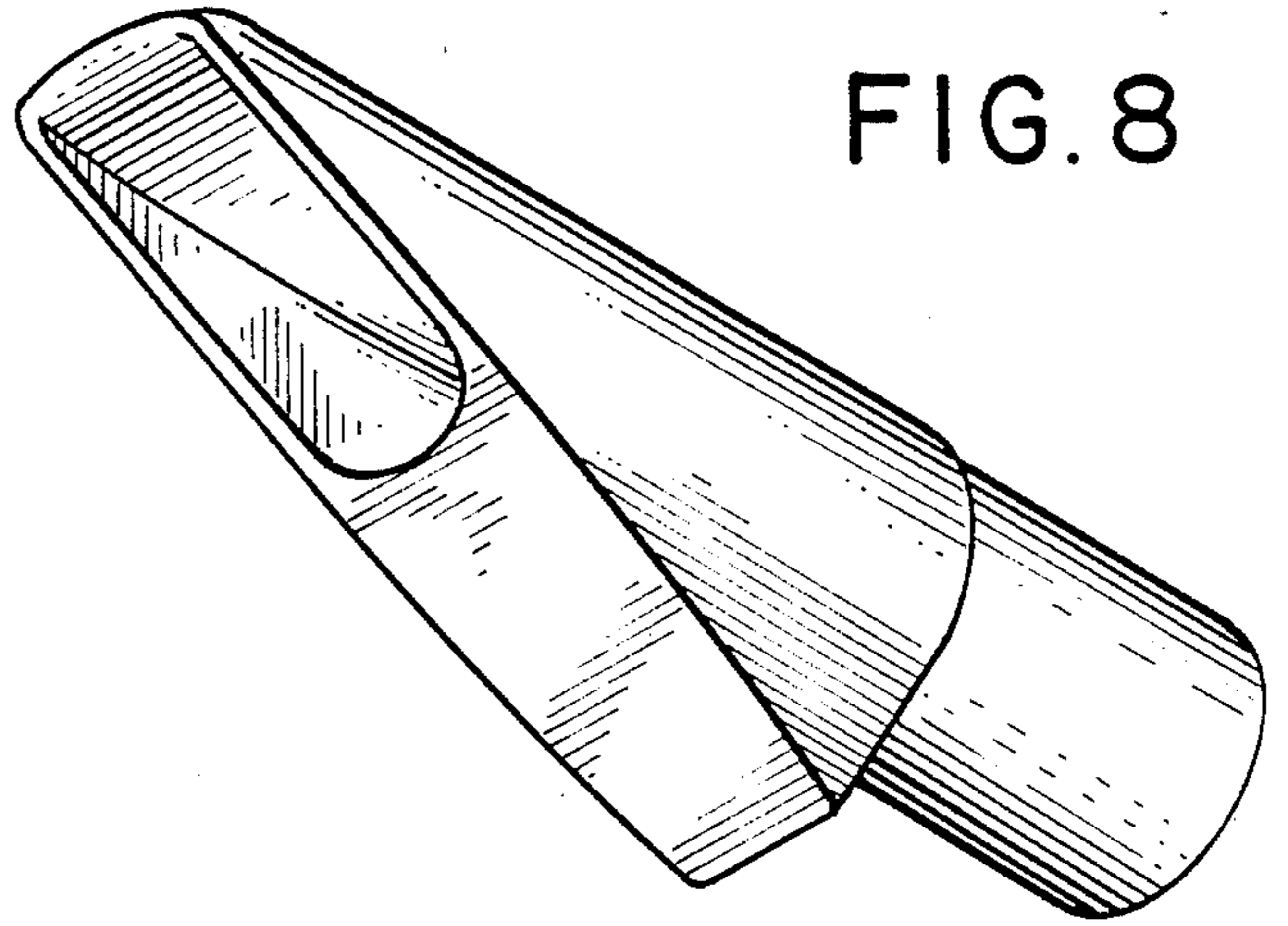

FIG. 14

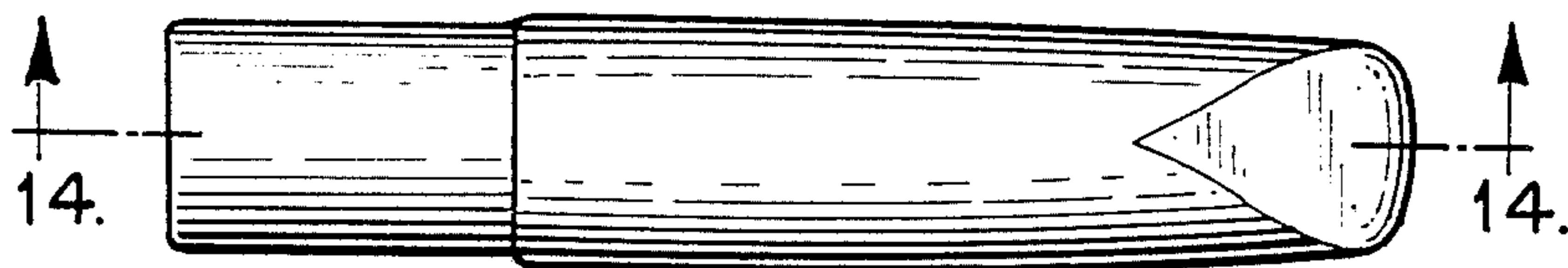
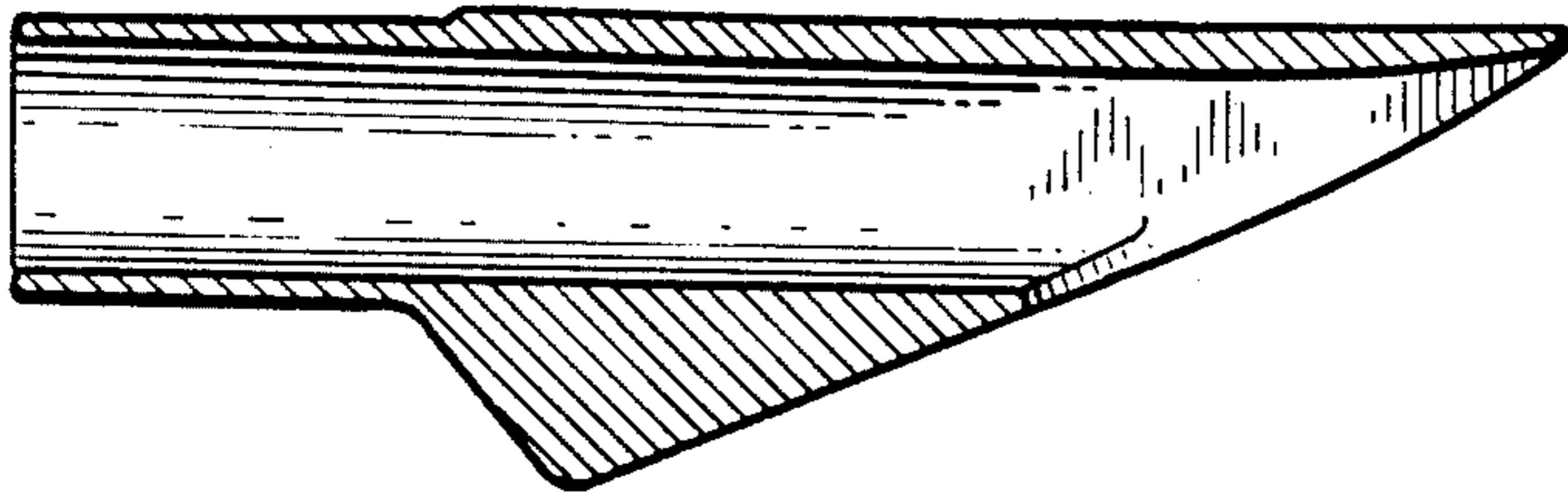

FIG. 9

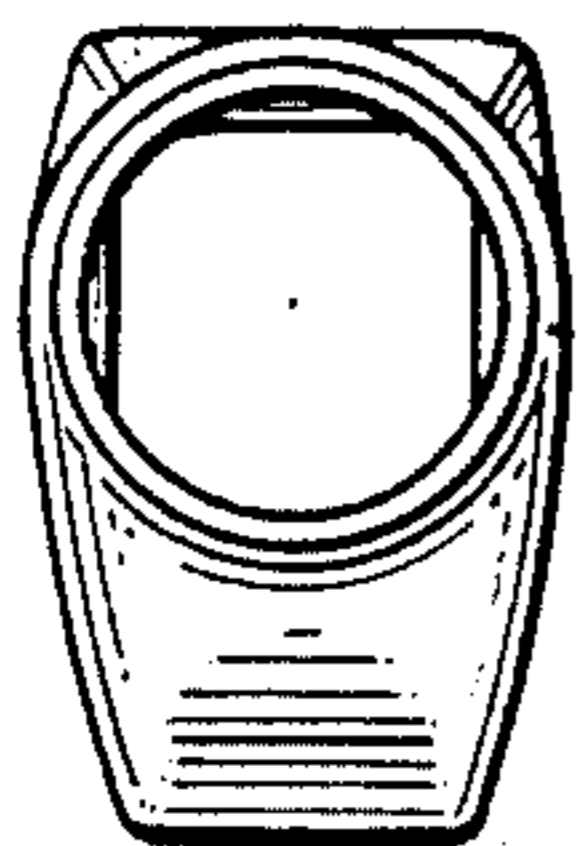

FIG. 10

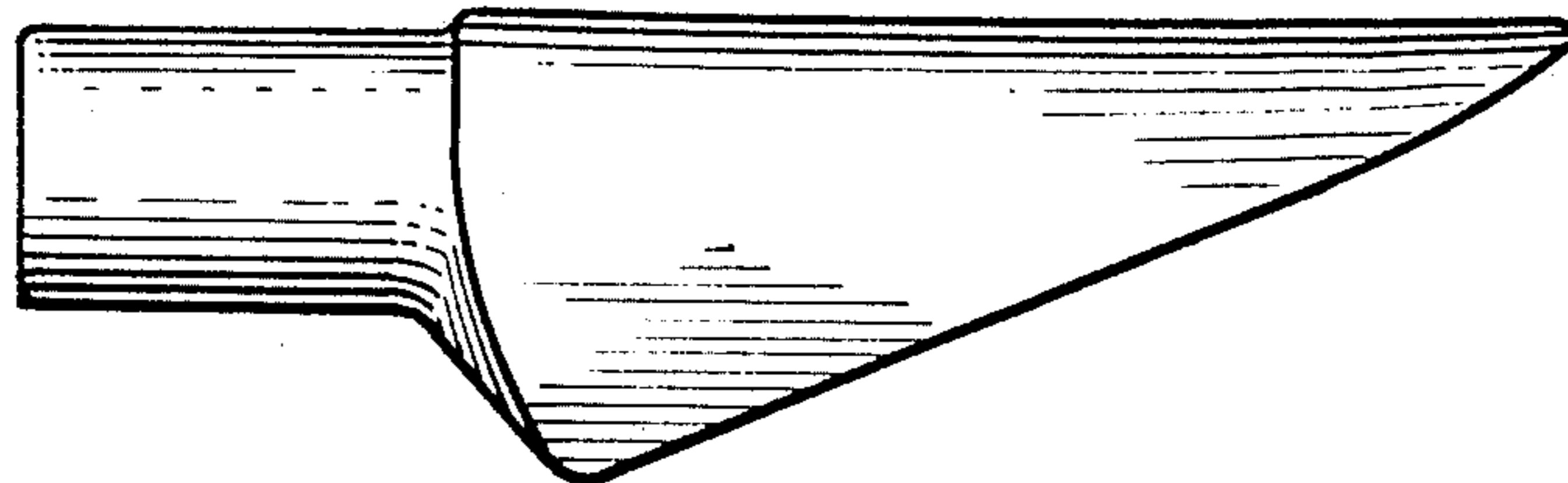

FIG. 11

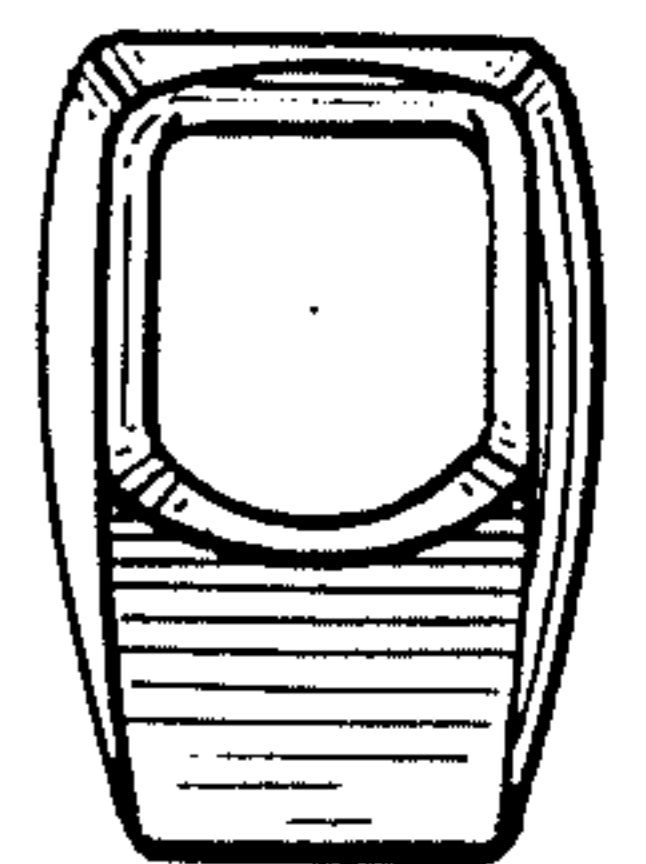

FIG. 12

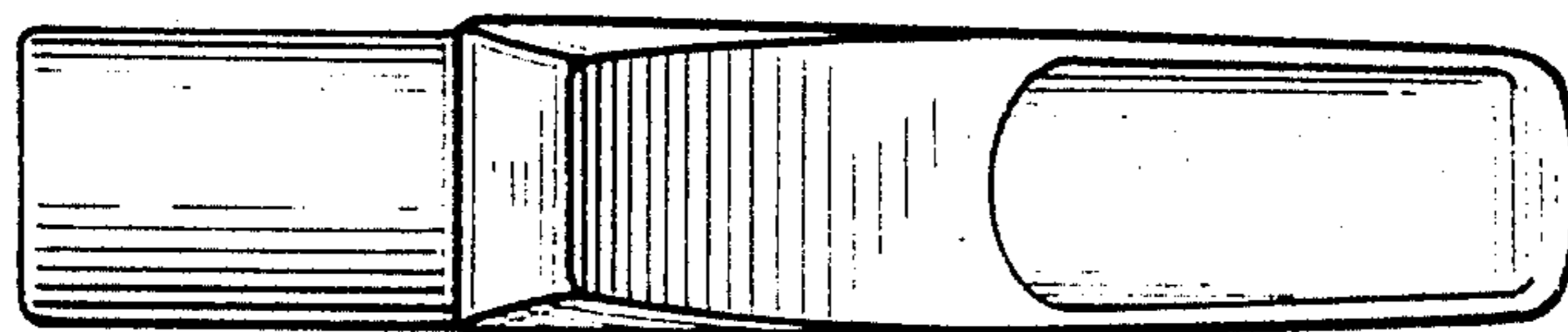

FIG. 13