

[54] **AIR SPOILER FOR TRUCKS**

[75] **Inventor: James R. Lund, Champlin, Minn.**

[73] **Assignee: Lund Industries, Inc., Minneapolis, Minn.**

[**] **Term: 14 Years**

[21] **Appl. No.: 862,558**

[22] **Filed: May 12, 1986**

[52] **U.S. Cl. D12/181**

[58] **Field of Search D12/181; 296/1.5, 91**

[56] **References Cited**

U.S. PATENT DOCUMENTS

D. 238,161 12/1975 De Vaughn D12/181

OTHER PUBLICATIONS

Commercial Carrier Journal, 7/85, p. 48, Air Spoiler on Truck Cab, bottom right side of page.

Commercial Carrier Journal, 8/85, p. 11, Air Spoiler on Truck Cab, center left side of page.

Commercial Carrier Journal, 10/85, p. 33, Air Spoiler on Truck Cab, top of page.

Primary Examiner—James M. Gandy
Attorney, Agent, or Firm—Merchant, Gould, Smith, Edell, Welter & Schmidt

[57] **CLAIM**

The ornamental design for an air spoiler for trucks, as shown and described.

DESCRIPTION

FIG. 1 is a front perspective view of an air spoiler for trucks showing my new design it being understood that the broken lines are for illustrative purposes only and form no part of the claimed design;

FIG. 2 is a front elevation view thereof;

FIG. 3 is a side elevation view thereof;

FIG. 4 is a side elevation view opposite that of FIG. 3;

FIG. 5 is a rear elevation view thereof;

FIG. 6 is a top plan view thereof;

FIG. 7 is a bottom plan view thereof;

FIG. 8 is an enlarged vertical section view taken substantially along the line 8—8 of FIG. 2; and,

FIG. 9 is an enlarged horizontal section view taken substantially along line 9—9 of FIG. 2.

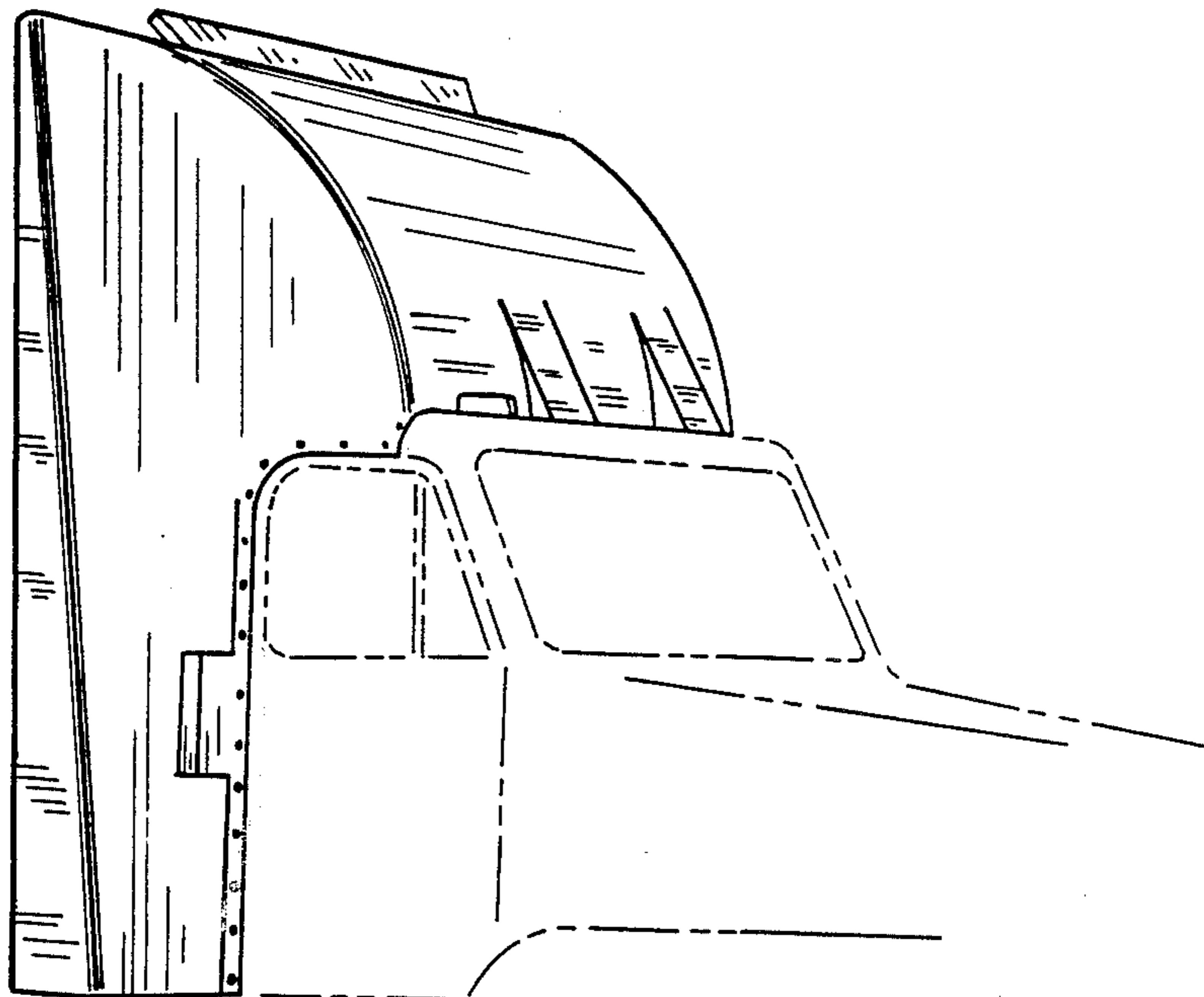

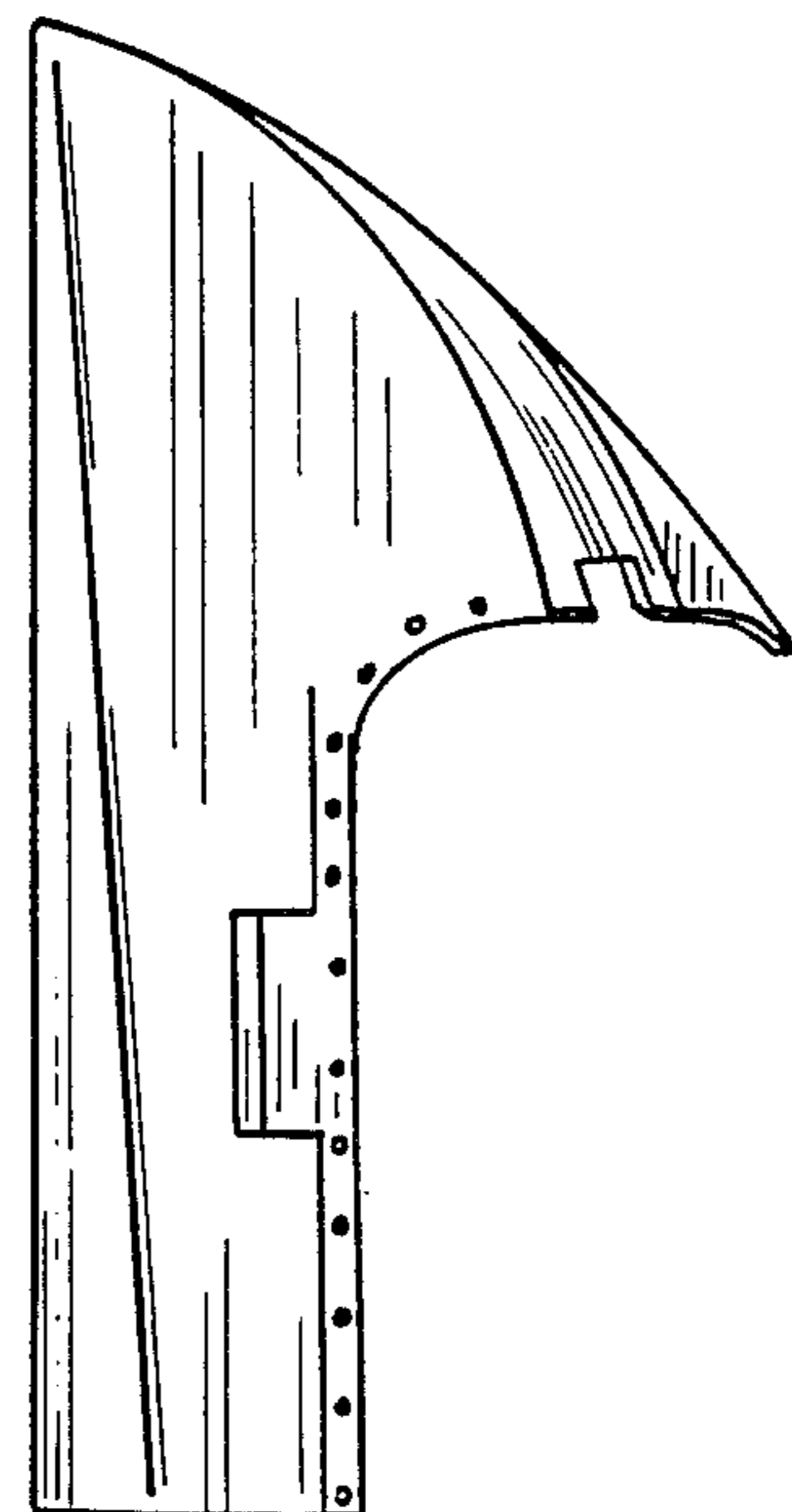
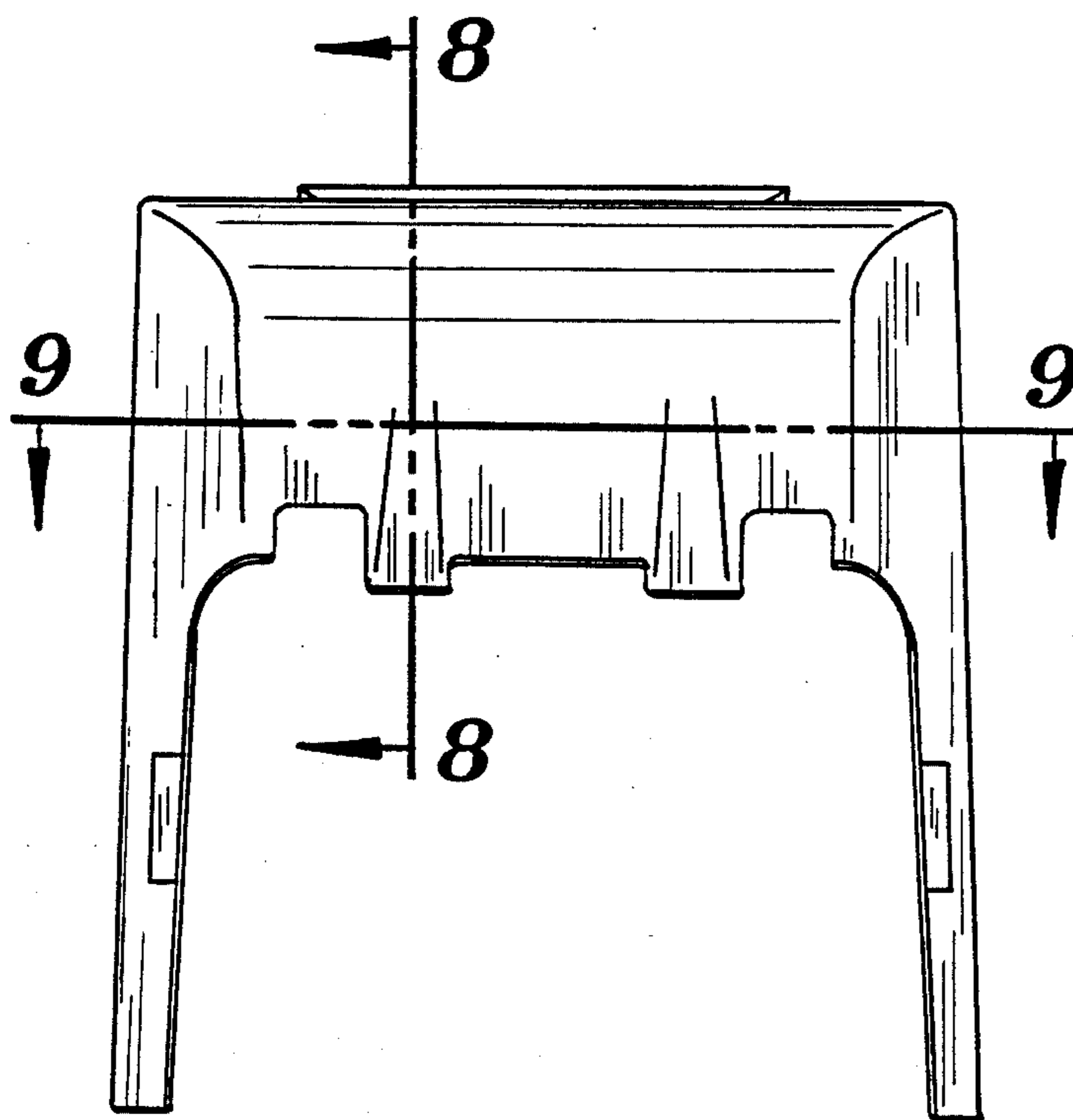
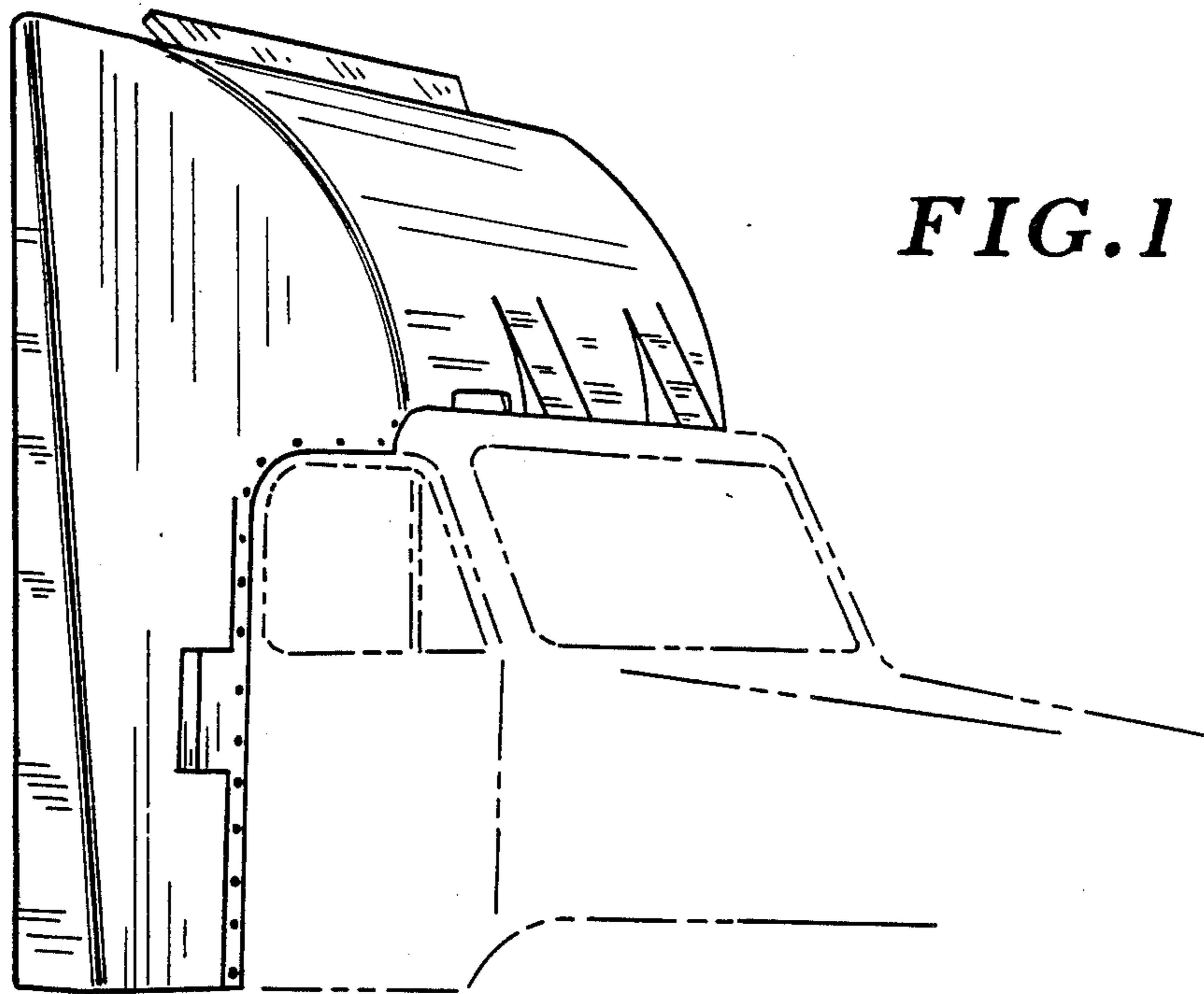

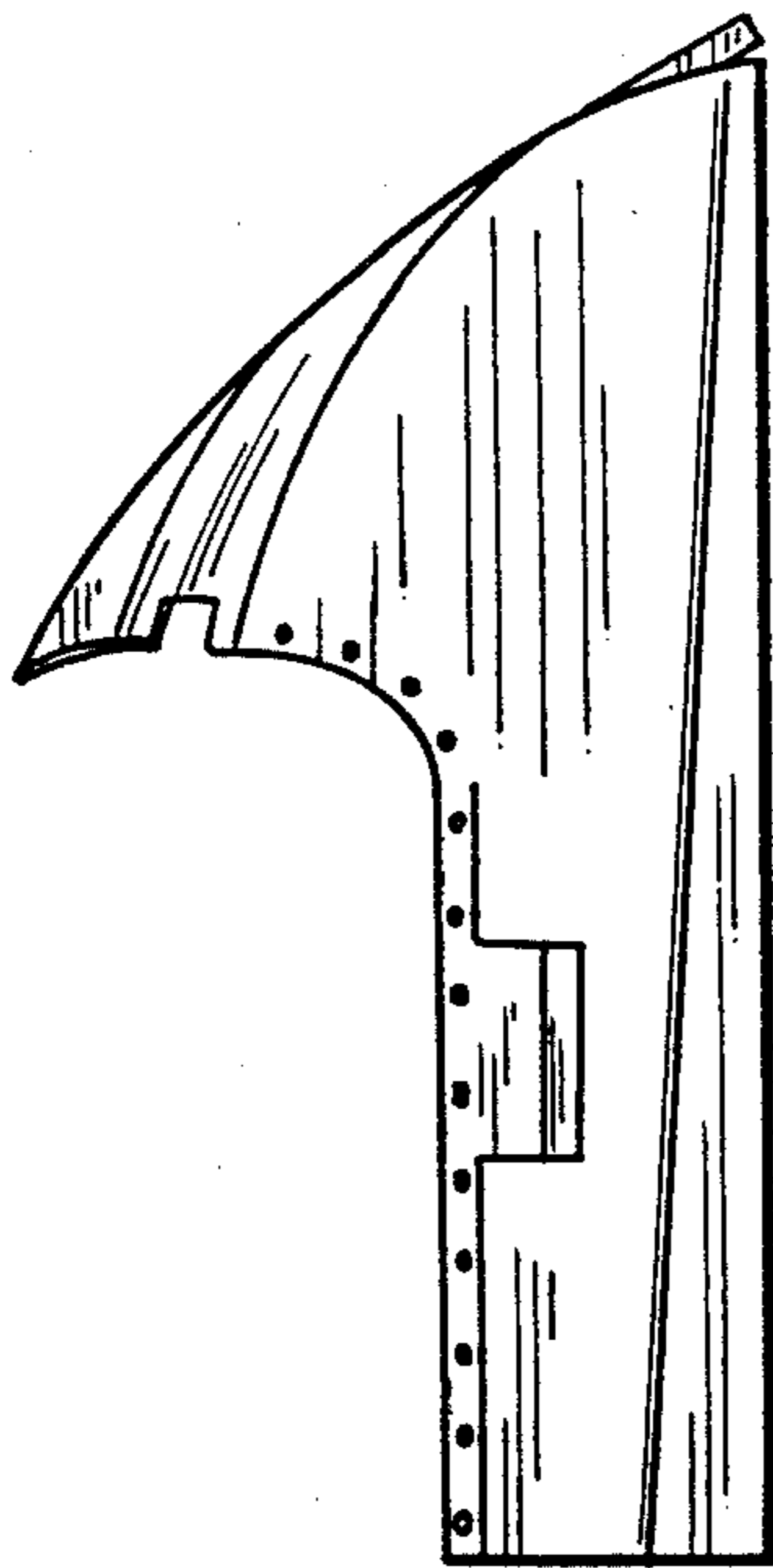

FIG. 4

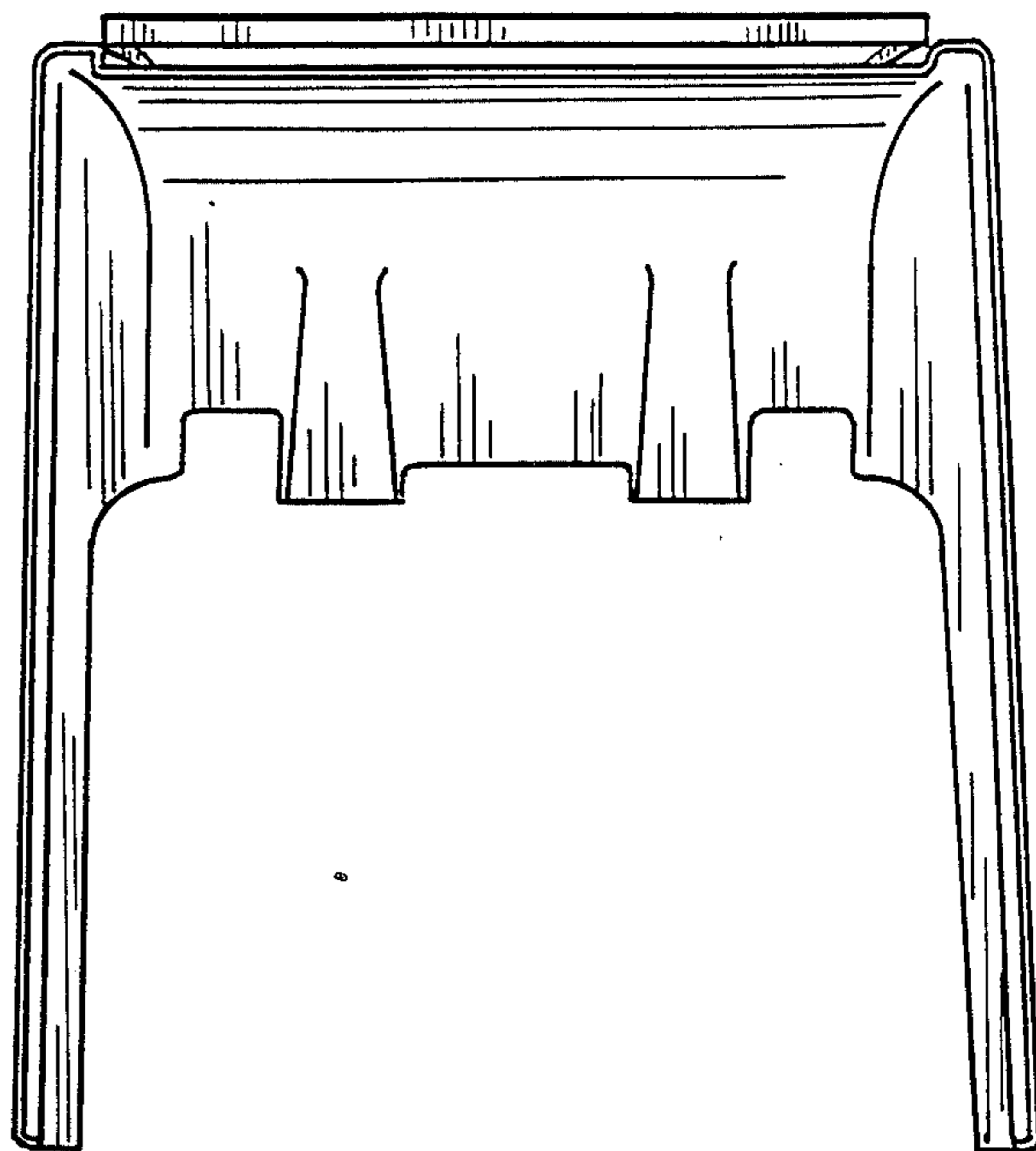

FIG. 5

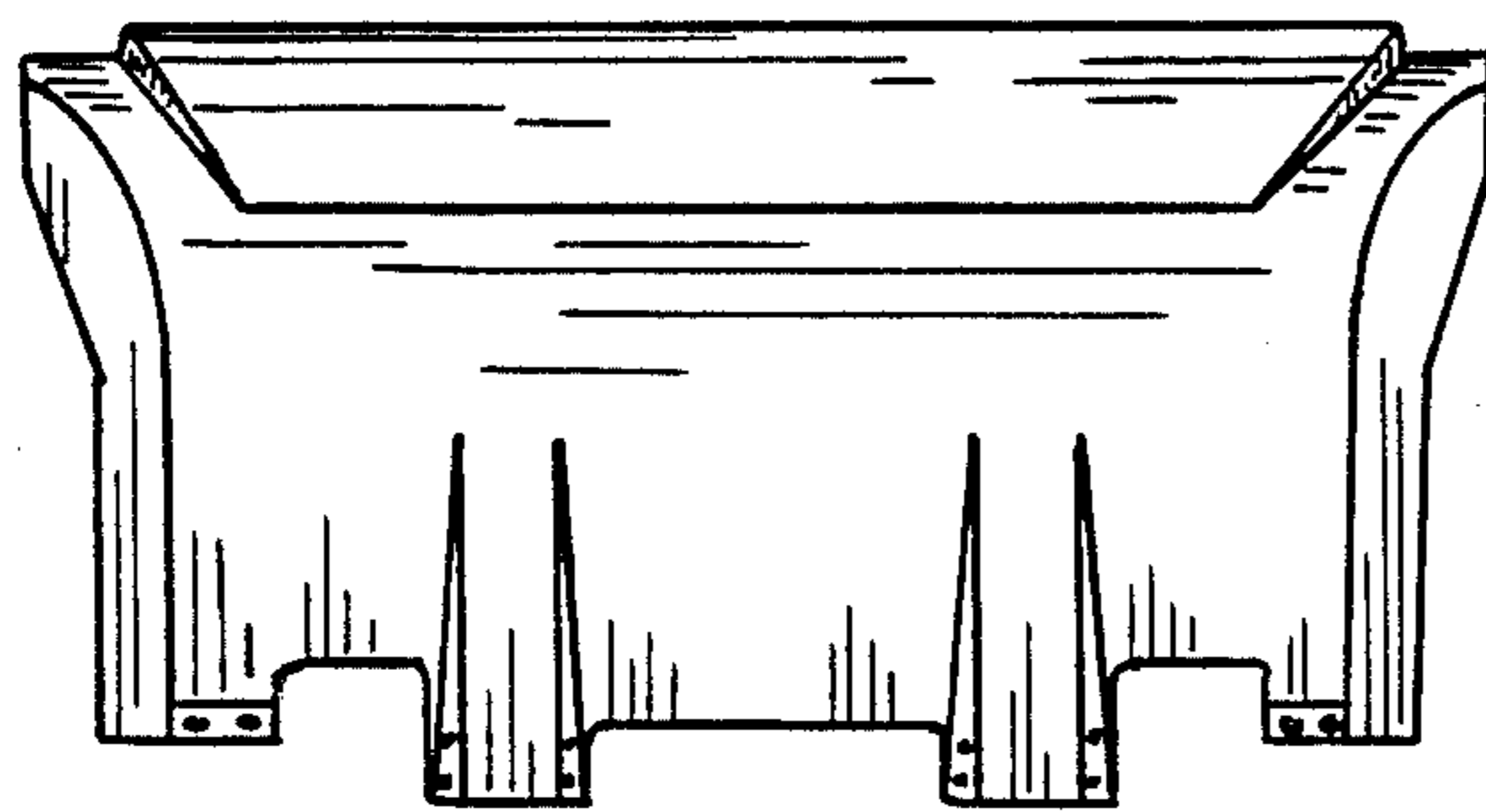

FIG. 6

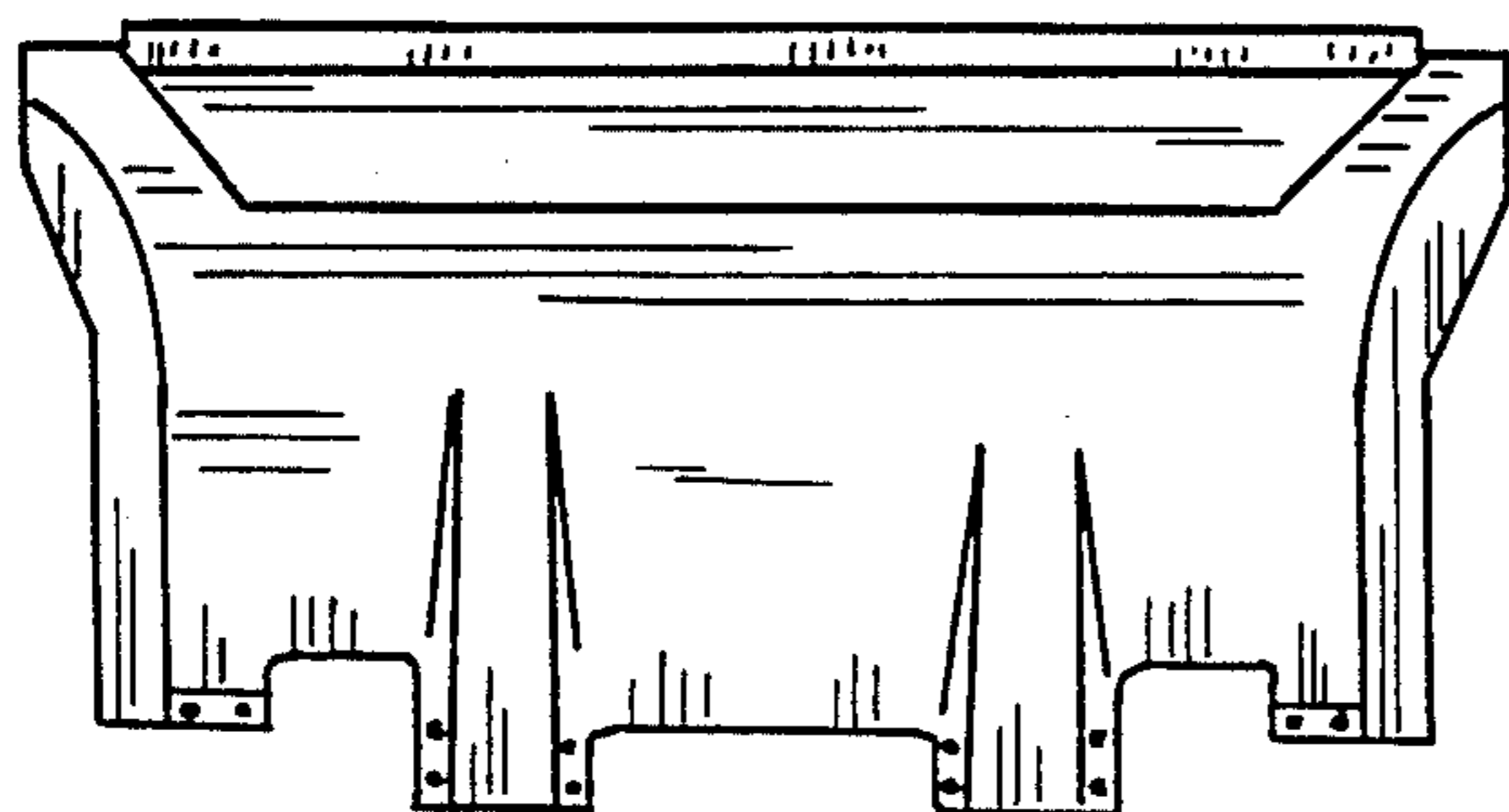

FIG. 7

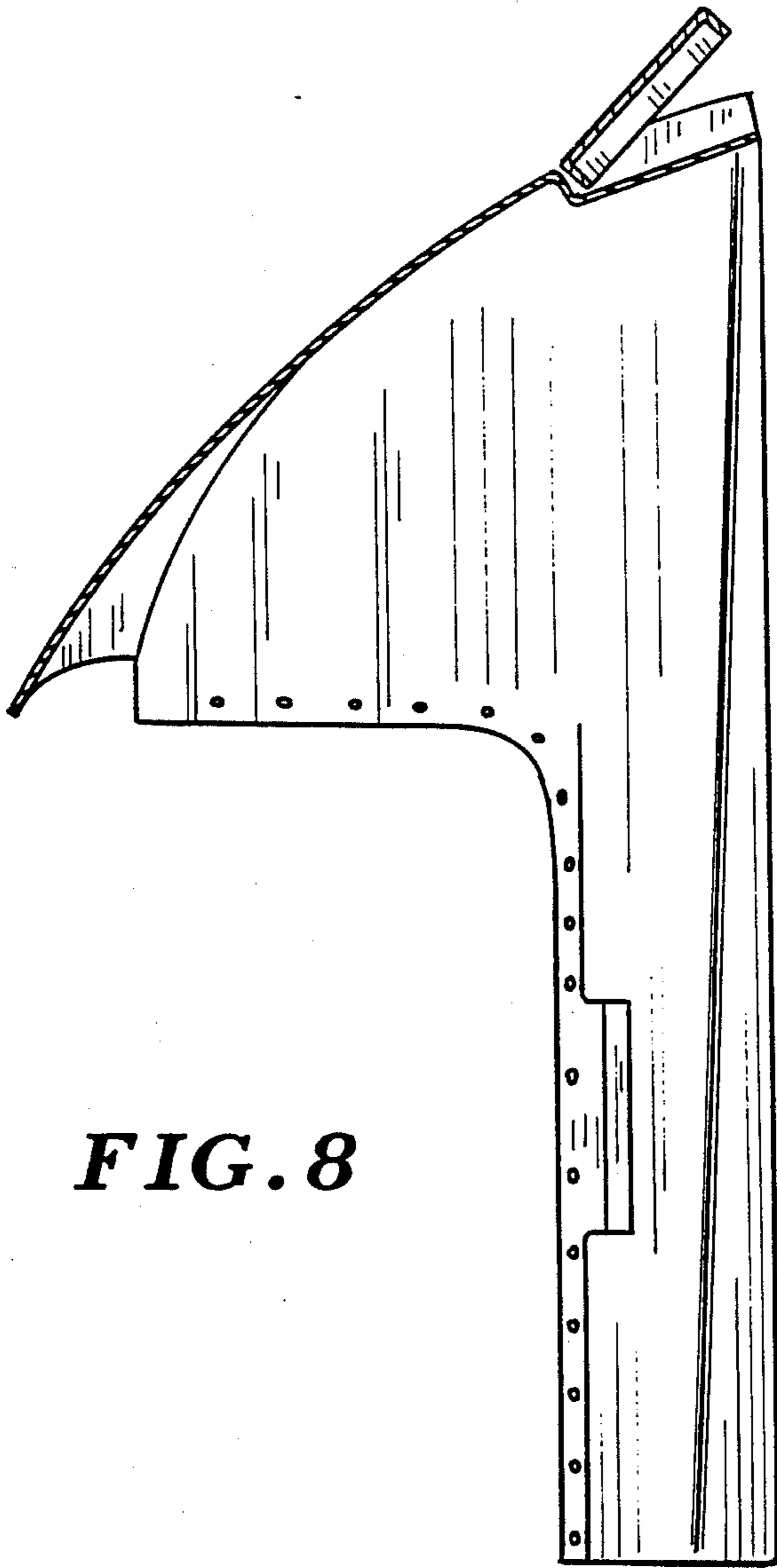

FIG. 8

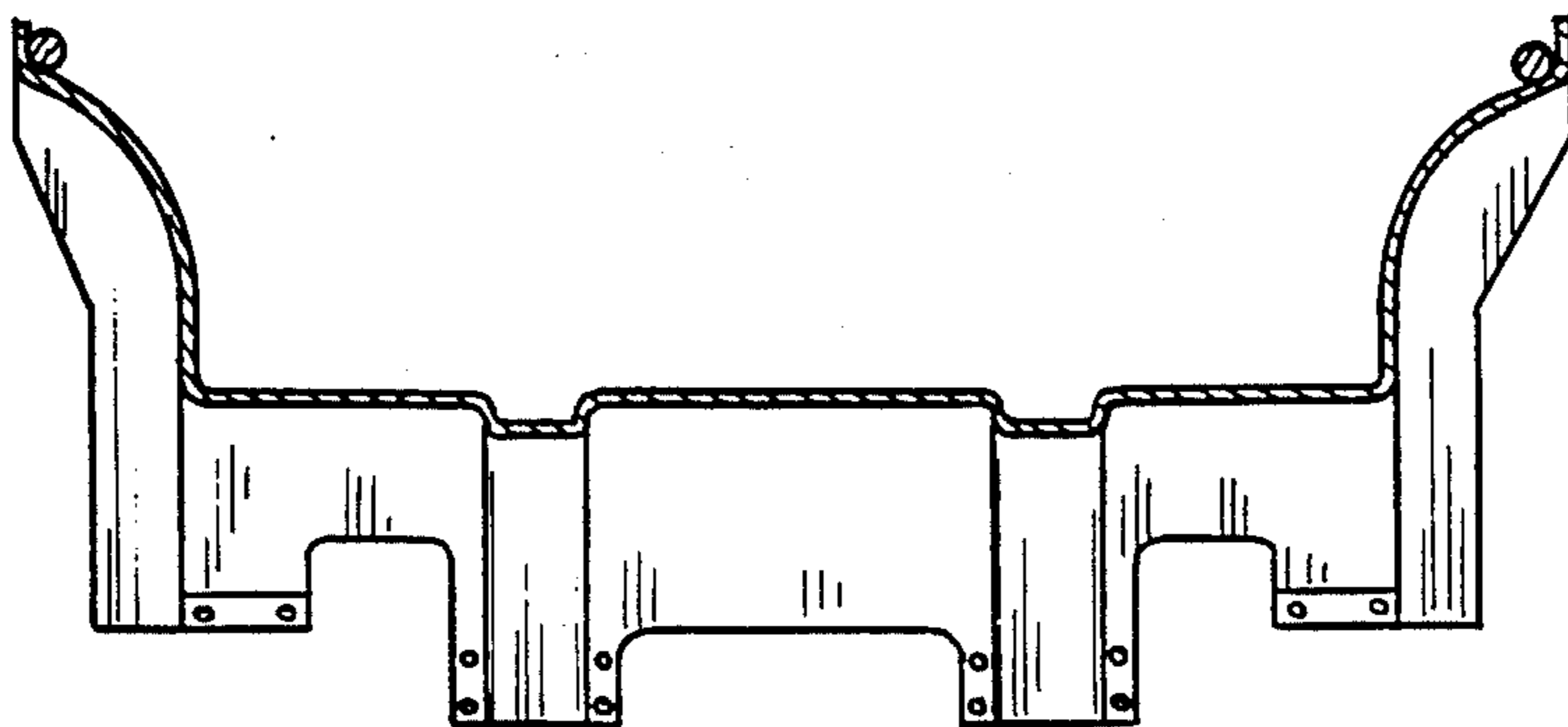

FIG. 9