

[54] **POLY-V PULLEY WITH BEARING HUB**

[75] **Inventor: Masahiro Kanemitsu, Kobe, Japan**

[73] **Assignee: Kabushiki Kaisha Kanemitsu, Japan**

[*] **Notice: The portion of the term of this patent subsequent to Mar. 15, 2002 has been disclaimed.**

[**] **Term: 14 Years**

[21] **Appl. No.: 880,913**

[22] **Filed: Jul. 1, 1986**

[52] **U.S. Cl. D8/360**

[58] **Field of Search D8/360**

[56] **References Cited**

U.S. PATENT DOCUMENTS

D. 266,982	11/1982	Kanemitsu	D8/360
D. 266,983	11/1982	Kanemitsu	D8/360
D. 266,984	11/1982	Kanemitsu	D8/360
D. 267,472	1/1983	Kanemitsu	D8/360
D. 267,540	1/1983	Kanemitsu	D8/360
D. 267,541	1/1983	Kanemitsu	D8/360
D. 268,092	3/1983	Kanemitsu	D8/360
D. 275,176	8/1984	Kanemitsu	D8/360
D. 275,365	9/1984	Kanemitsu	D8/360
D. 276,409	11/1984	Kanemitsu	D8/360
D. 277,547	2/1985	Kanemitsu	D8/360
D. 294,675	3/1988	Kanemitsu	D8/360
D. 297,707	9/1988	Kanemitsu	D8/360
2,139,833	12/1938	Le Jeune et al.	29/159.1
2,471,906	5/1949	Smith	474/170
2,656,730	10/1953	Mitchell	29/159 R
2,787,914	4/1957	Nelson	474/168
2,878,551	3/1959	Woodward	29/159.1
3,368,376	2/1967	Previte	72/82
3,457,751	7/1969	Lindeman	72/105
3,722,309	3/1973	Shaffer	474/169
3,772,928	11/1973	Gobeille	74/230.7
3,838,485	10/1974	Oldford	474/170
3,907,371	9/1975	Leudi et al.	29/159.1
3,945,102	3/1976	Kotlar	29/159 R
3,953,995	5/1976	Haswell et al.	72/105
3,962,926	6/1976	Kotlar	474/168
3,977,264	8/1976	Sproul	29/159 R
3,994,181	11/1976	Sproul	474/170
4,050,321	9/1977	Kraft	74/230.8
4,059,023	11/1977	Sproul	474/170

4,078,410	3/1978	Lemmo	72/82
4,080,704	3/1978	Blakesley	29/159 R
4,083,215	4/1978	Guetzlaff	72/82
4,086,798	5/1978	Lemmo	72/82
4,197,756	4/1980	Yaros	74/230.3
4,273,547	6/1981	Bytzek	474/170
4,313,323	2/1982	Kanemitsu	72/84
4,455,853	6/1984	Kanemitsu	72/84
4,518,374	5/1985	Kanemitsu	474/170
4,524,595	6/1985	Oda	72/84
4,551,122	11/1985	Kraft et al.	474/170

FOREIGN PATENT DOCUMENTS

2822056	11/1979	Fed. Rep. of Germany	474/170
508176	1/1955	Italy	474/170
11260	5/1979	Japan	72/105
143863	11/1981	Japan	29/159 R
90459	6/1982	Japan	29/159 R
195551	12/1982	Japan	29/159 R
128564	8/1983	Japan	29/159 R
163538	9/1983	Japan	29/159 R
13535	1/1984	Japan	29/159 R

OTHER PUBLICATIONS

Advertising brochure entitled Carina Ed.
Semitol brochure on Rinser/Dryers (38320), 1983.

Primary Examiner—Horace B. Fay, Jr.
Attorney, Agent, or Firm—Steele, Gould & Fried

[57] **CLAIM**

The ornamental design for a poly-v pulley with bearing hub, as shown and described.

DESCRIPTION

FIGS. 1 and 2 are respectively front and rear elevational views of a poly-v pulley with bearing hub showing my new design;
FIG. 3 is a side elevational view thereof, the opposite side being a mirror image;
FIG. 4 is a sectional view of the pulley shown in FIGS. 1-3;
FIGS. 5 and 6 are respectively front and rear elevational views of a second embodiment thereof, the pulley having an internal sloping flange, as shown in FIG. 8;
FIG. 7 is a side elevational view thereof, the opposite side being a mirror image;
FIG. 8 is a sectional view thereof;

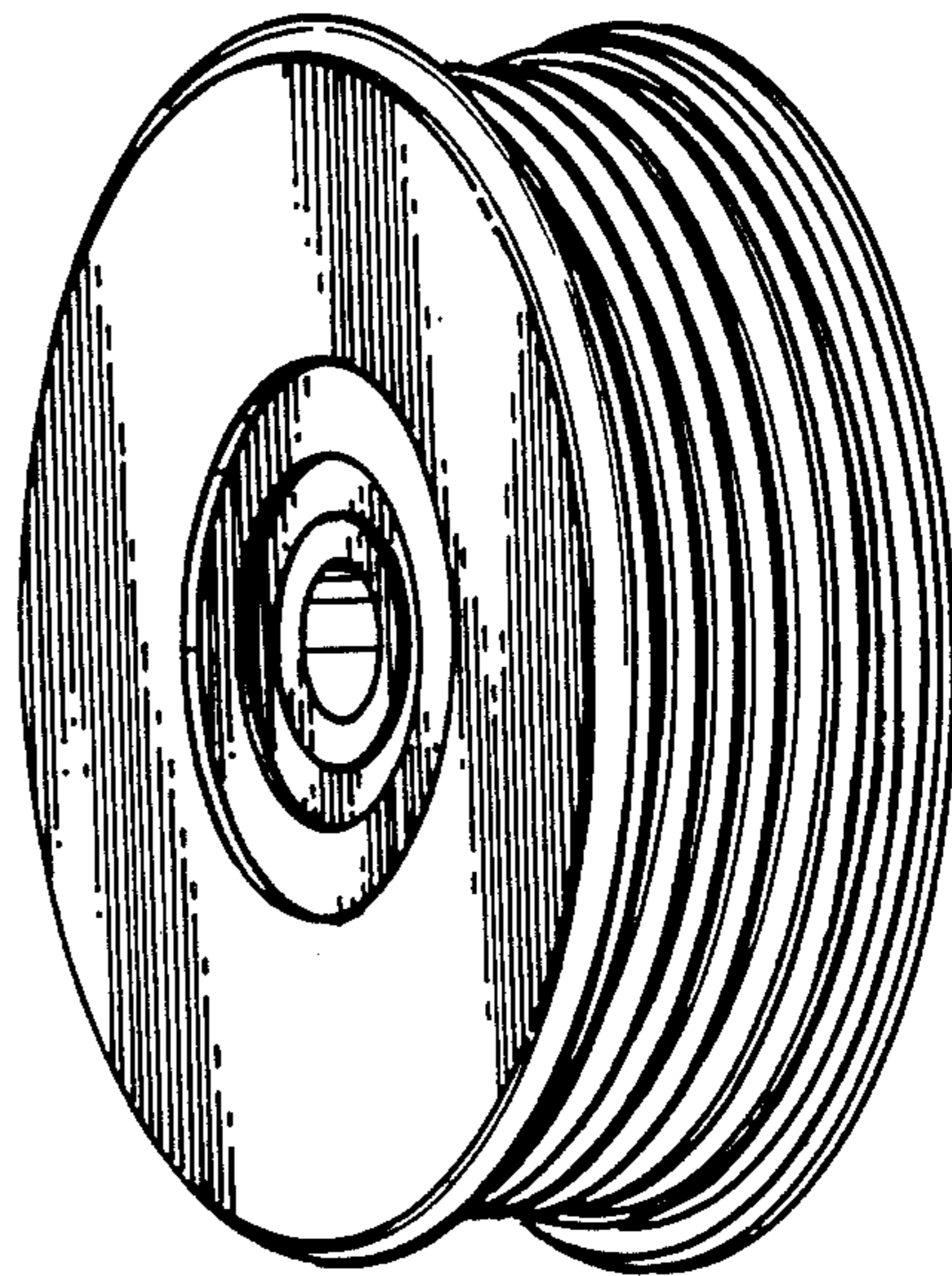

FIGS. 9 and 10 are respectively front and rear elevational views of a third embodiment thereof, the pulley having an internal curved flange, as shown in **FIG. 12**; **FIG. 11** is a side elevational view thereof, the opposite side being a mirror image;
FIG. 12 is a sectional view thereof;

FIGS. 13 and 14 are respectively front and rear perspective views of the first embodiment;
FIGS. 15 and 16 are respectively front and rear perspective views of the second embodiment;
FIGS. 17 and 18 are respectively front and rear perspective views of the third embodiment.
The broken line showing of ball bearings in **FIGS. 4, 8 and 12** is for illustrative purposes only and forms no part of the claimed design.

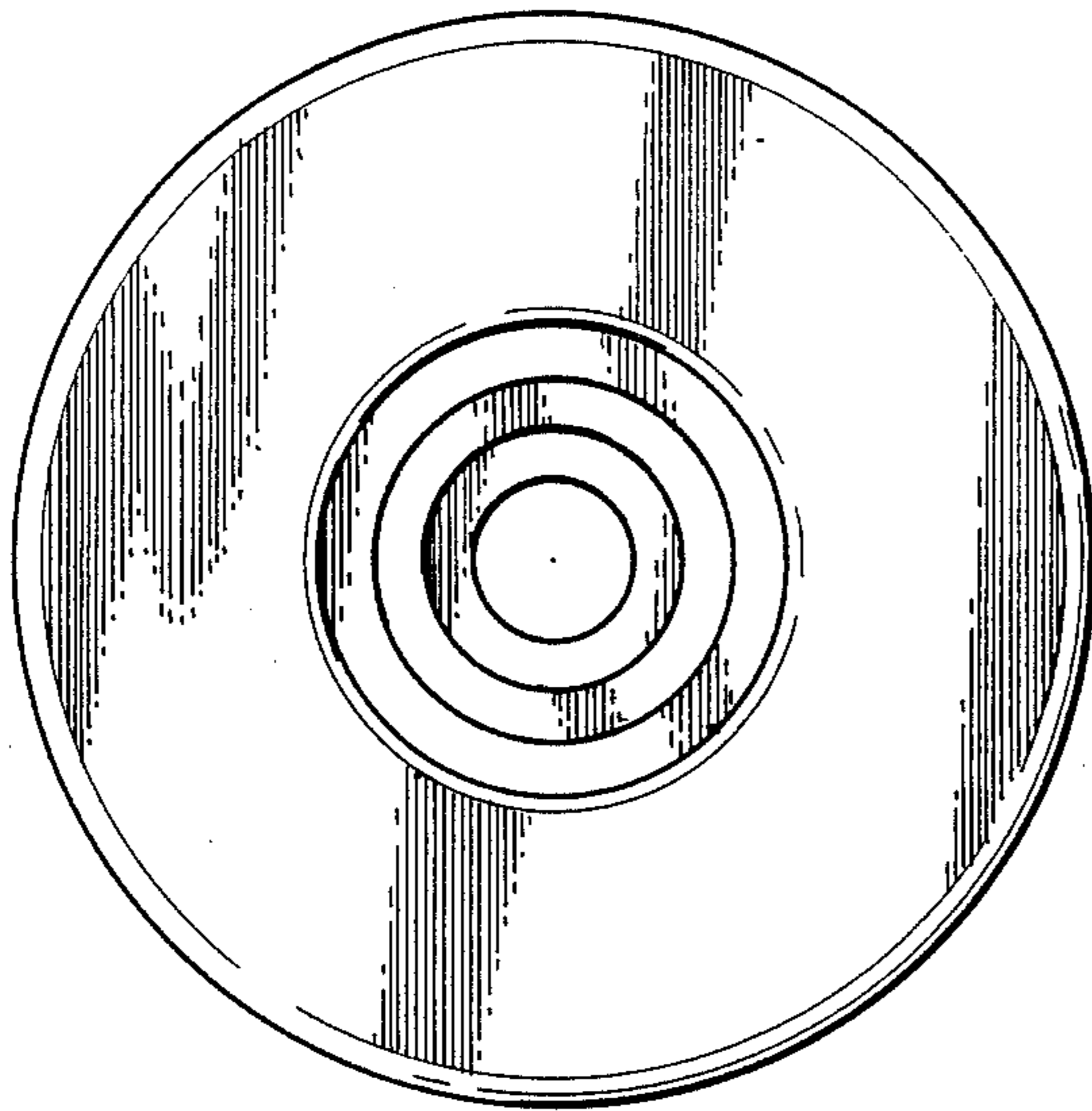

FIG. 1

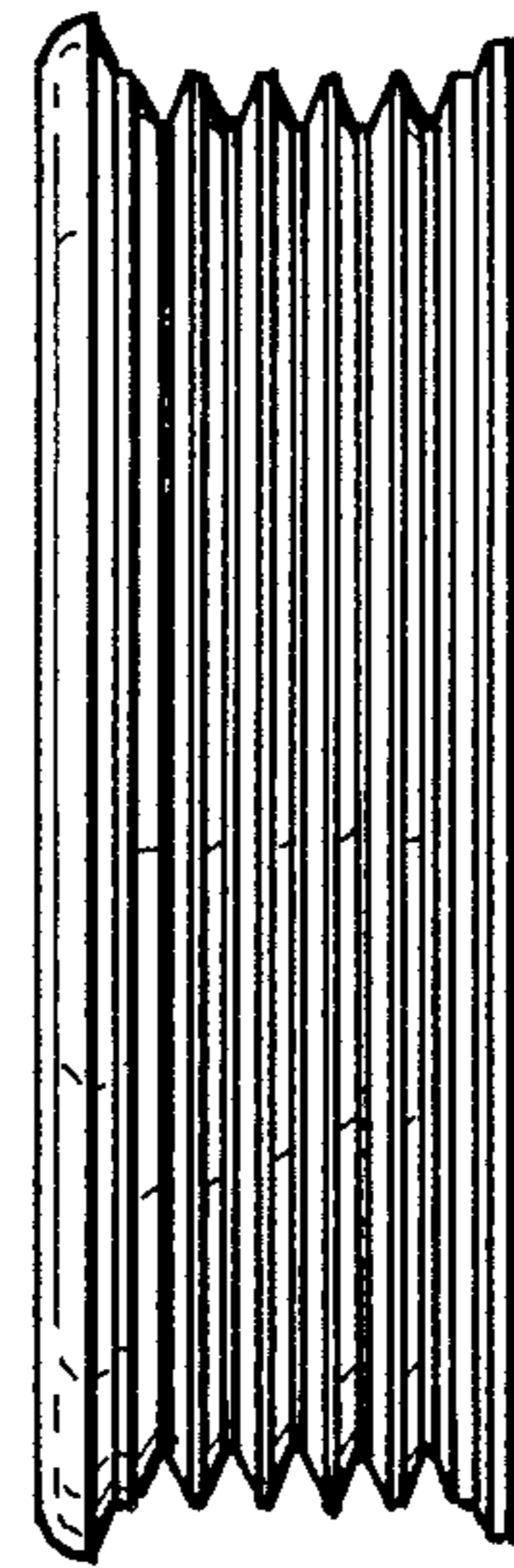

FIG. 3

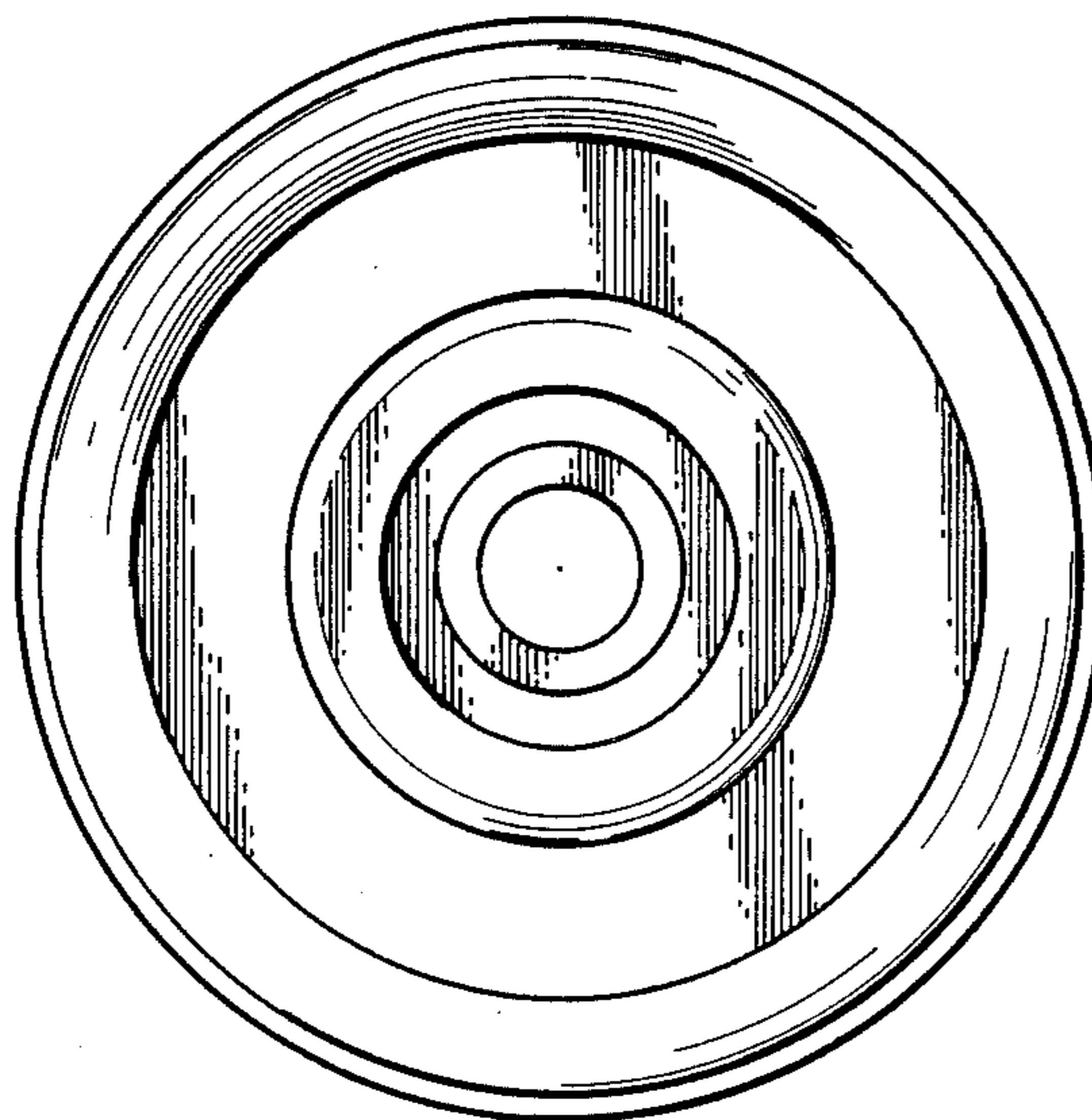

FIG. 2

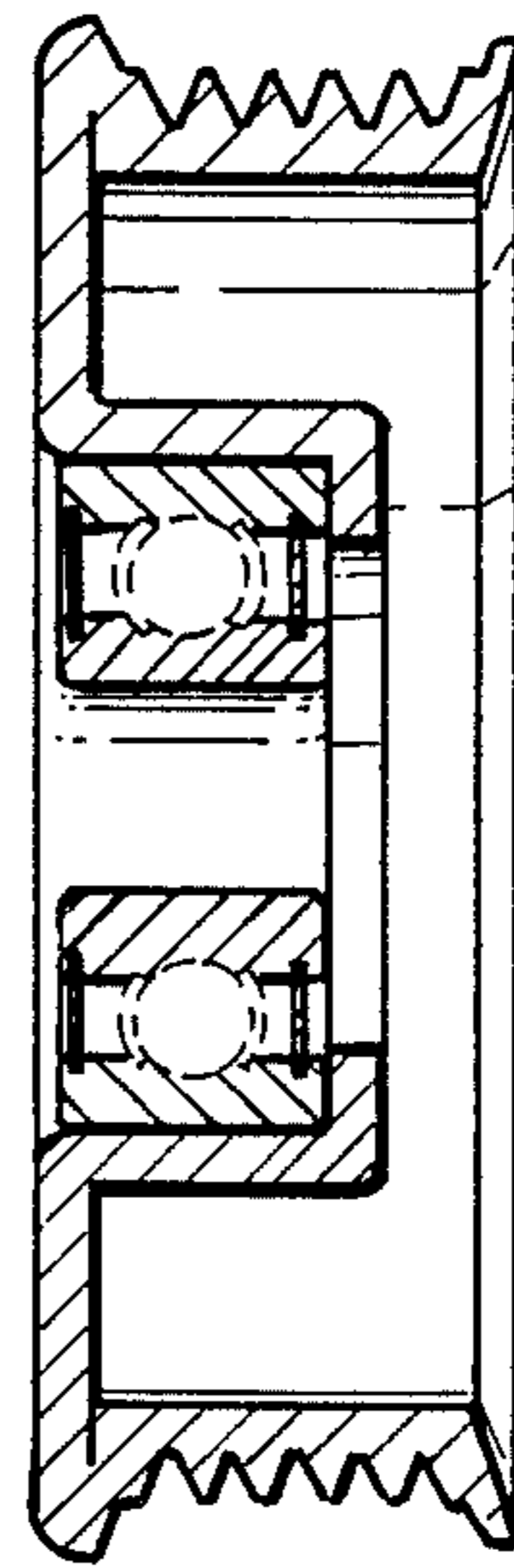

FIG. 4

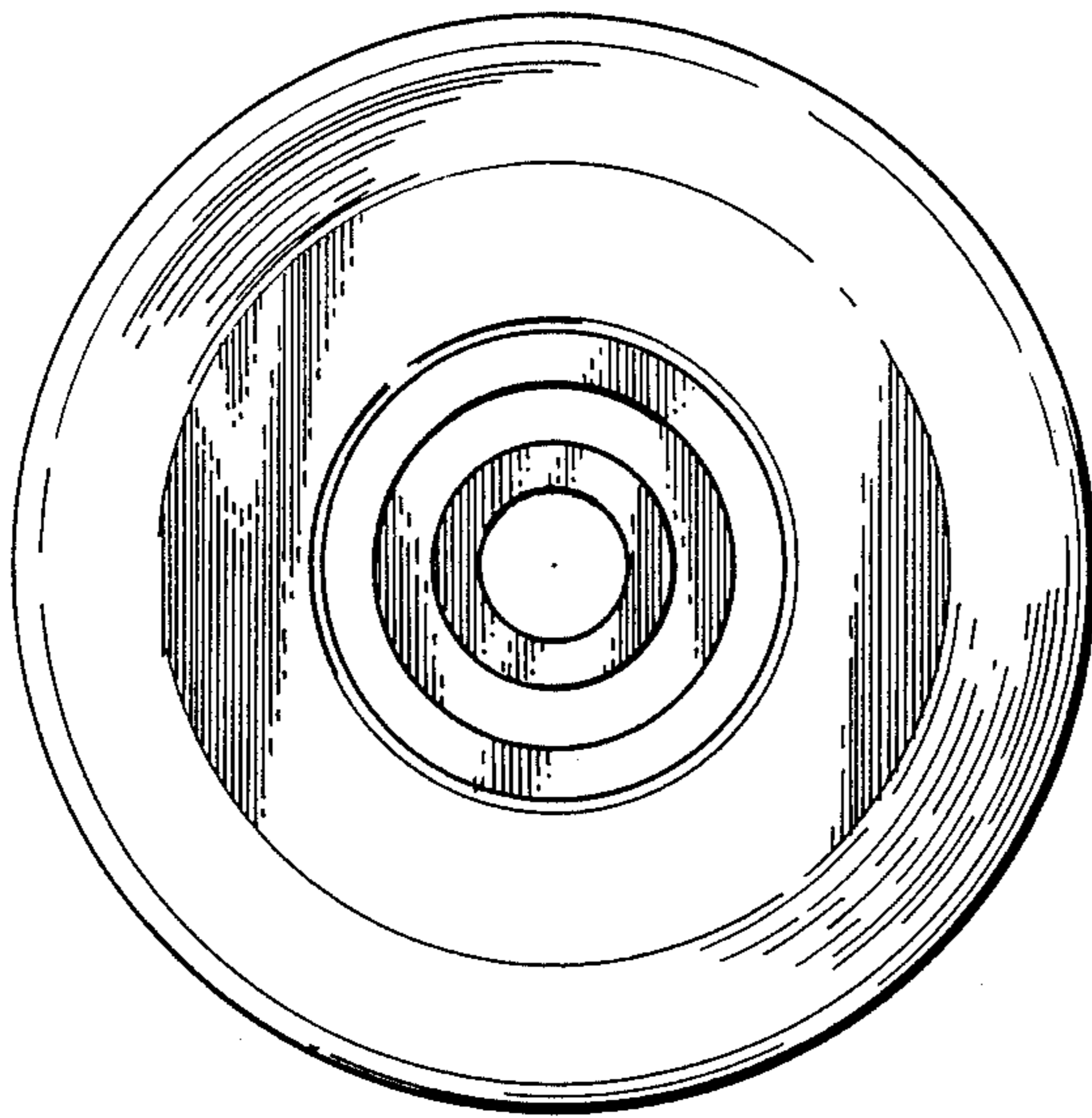

FIG. 5



FIG. 7

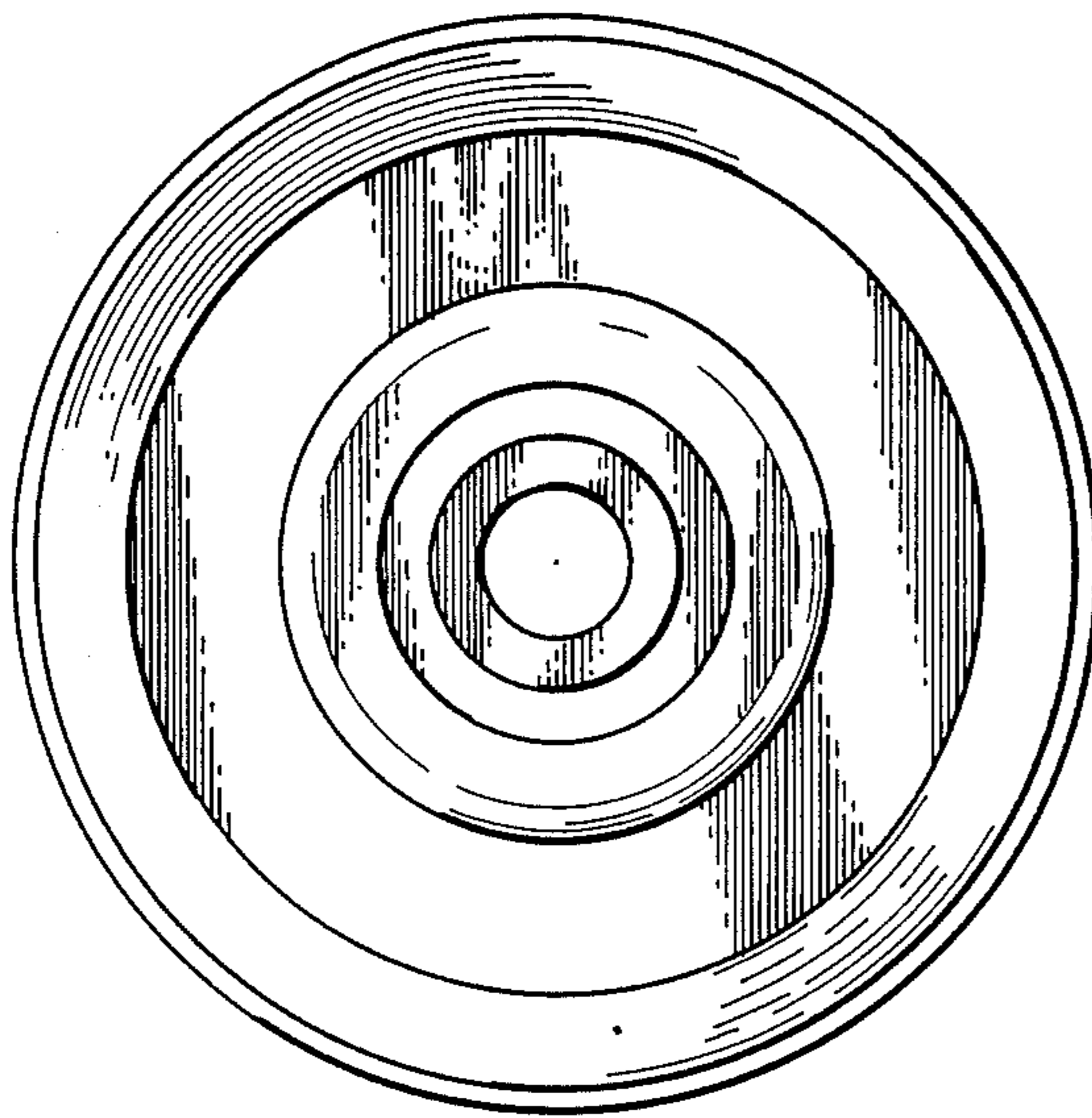

FIG. 6

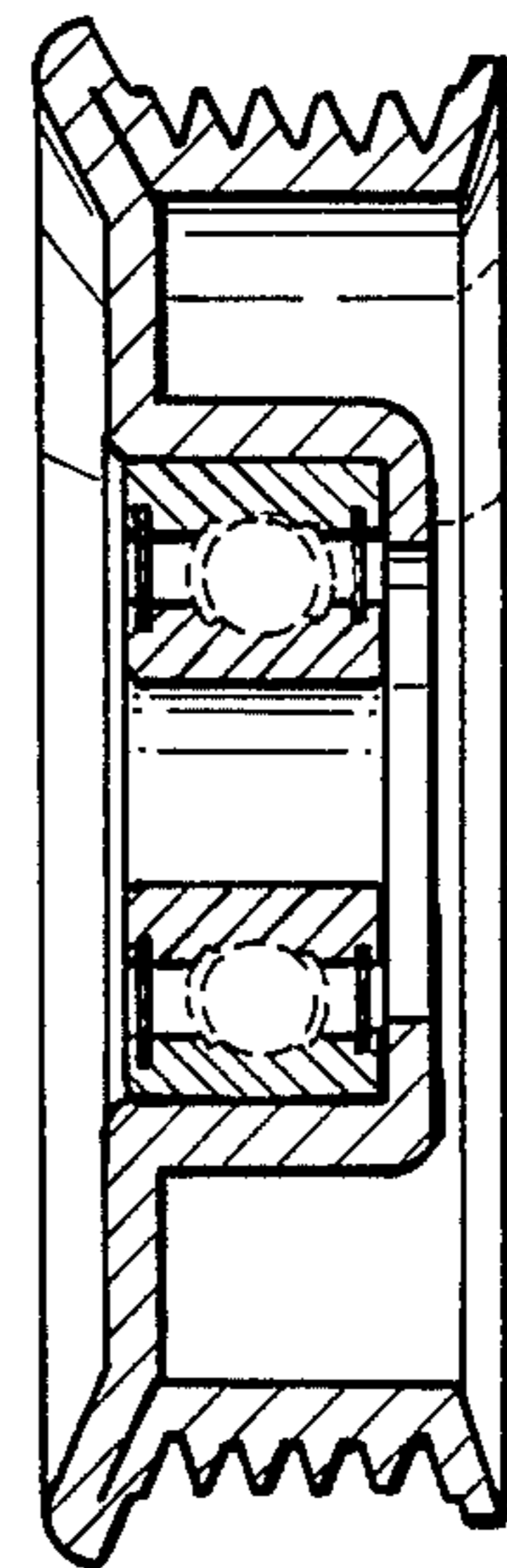

FIG. 8

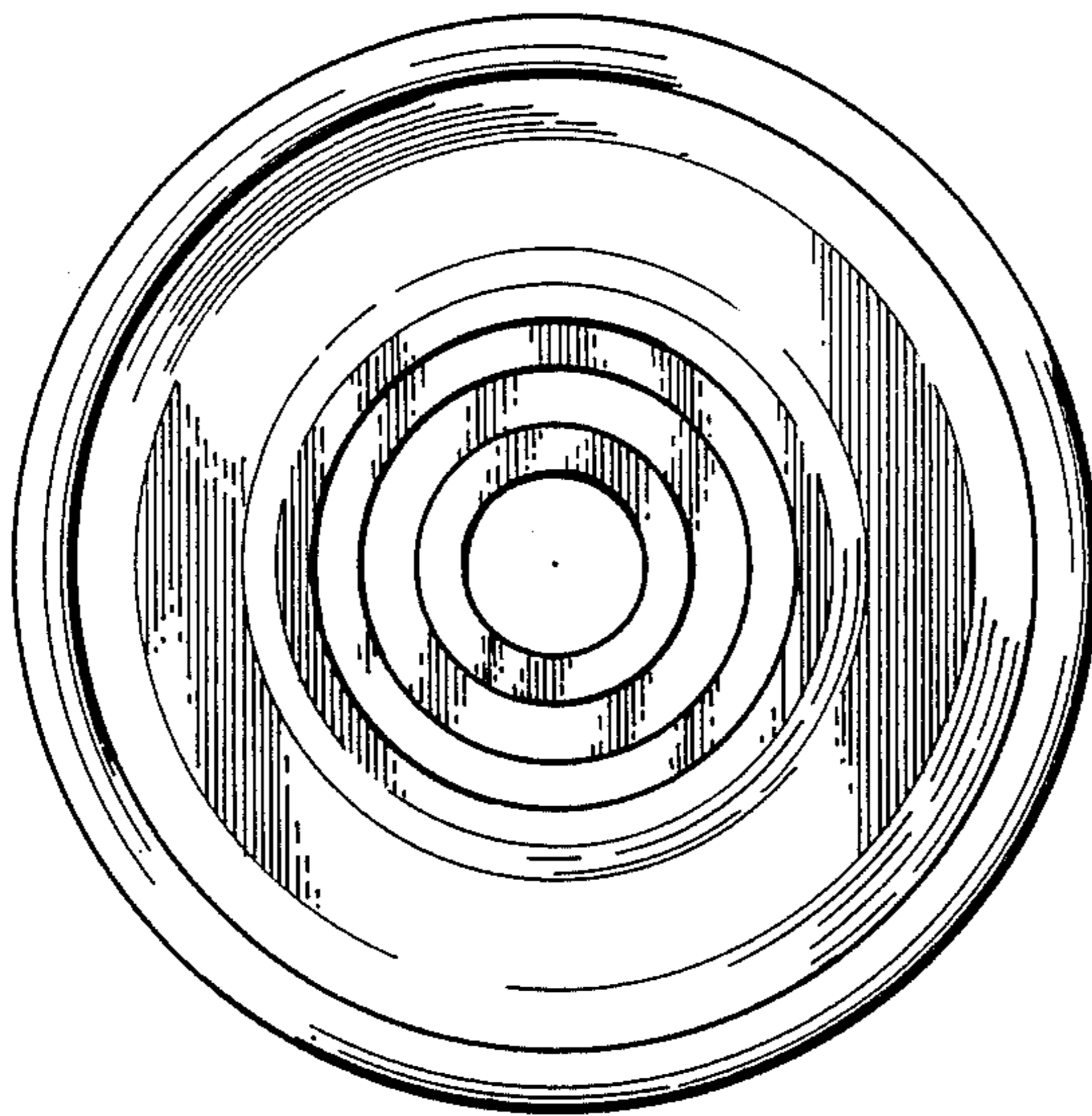

FIG. 9



FIG. 11

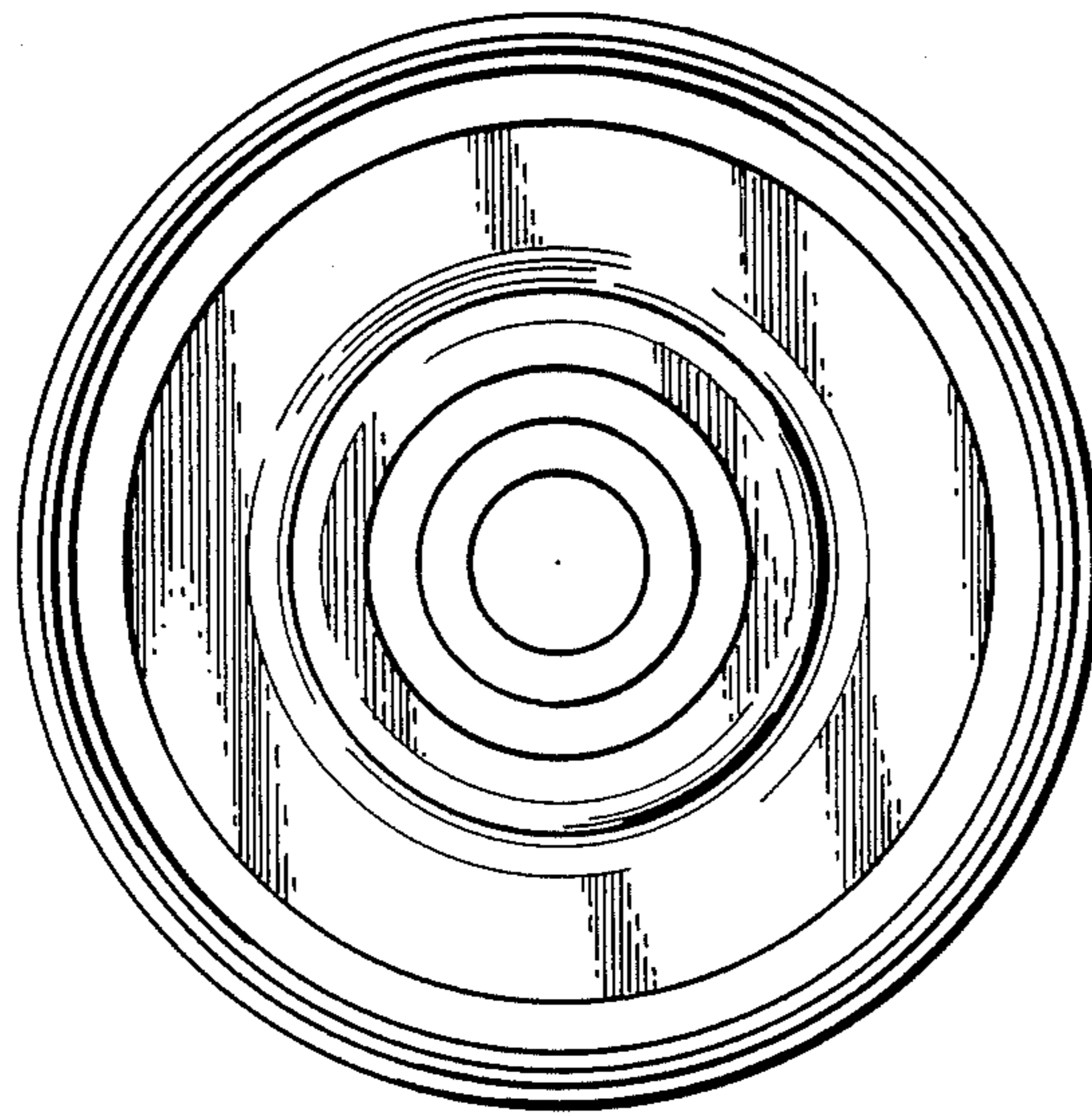

FIG. 10

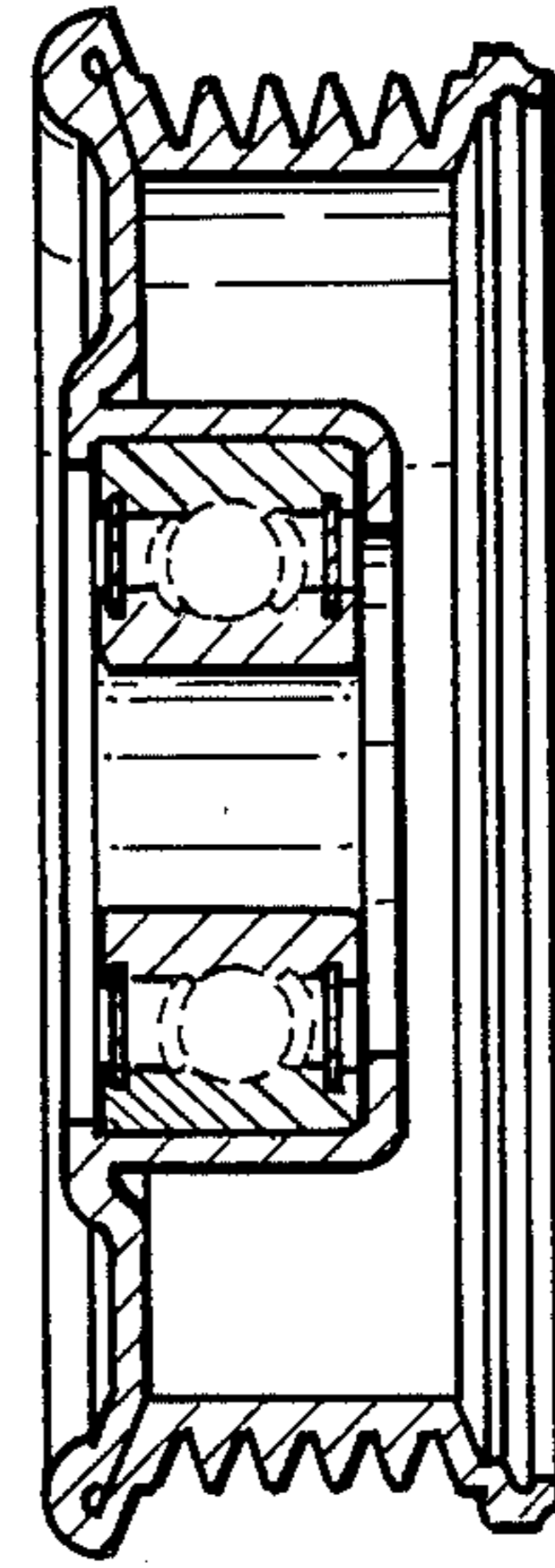

FIG. 12

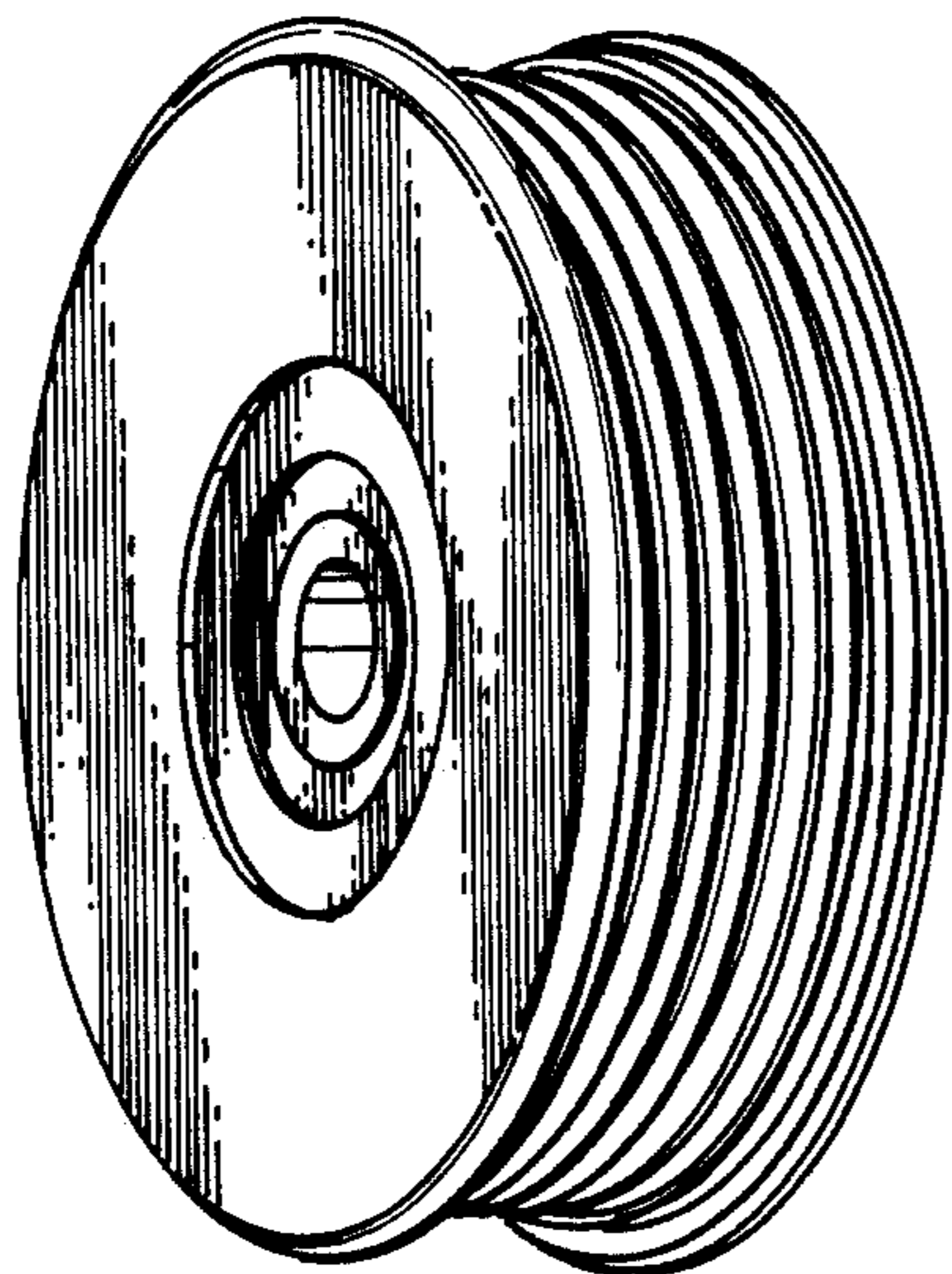

FIG. 13

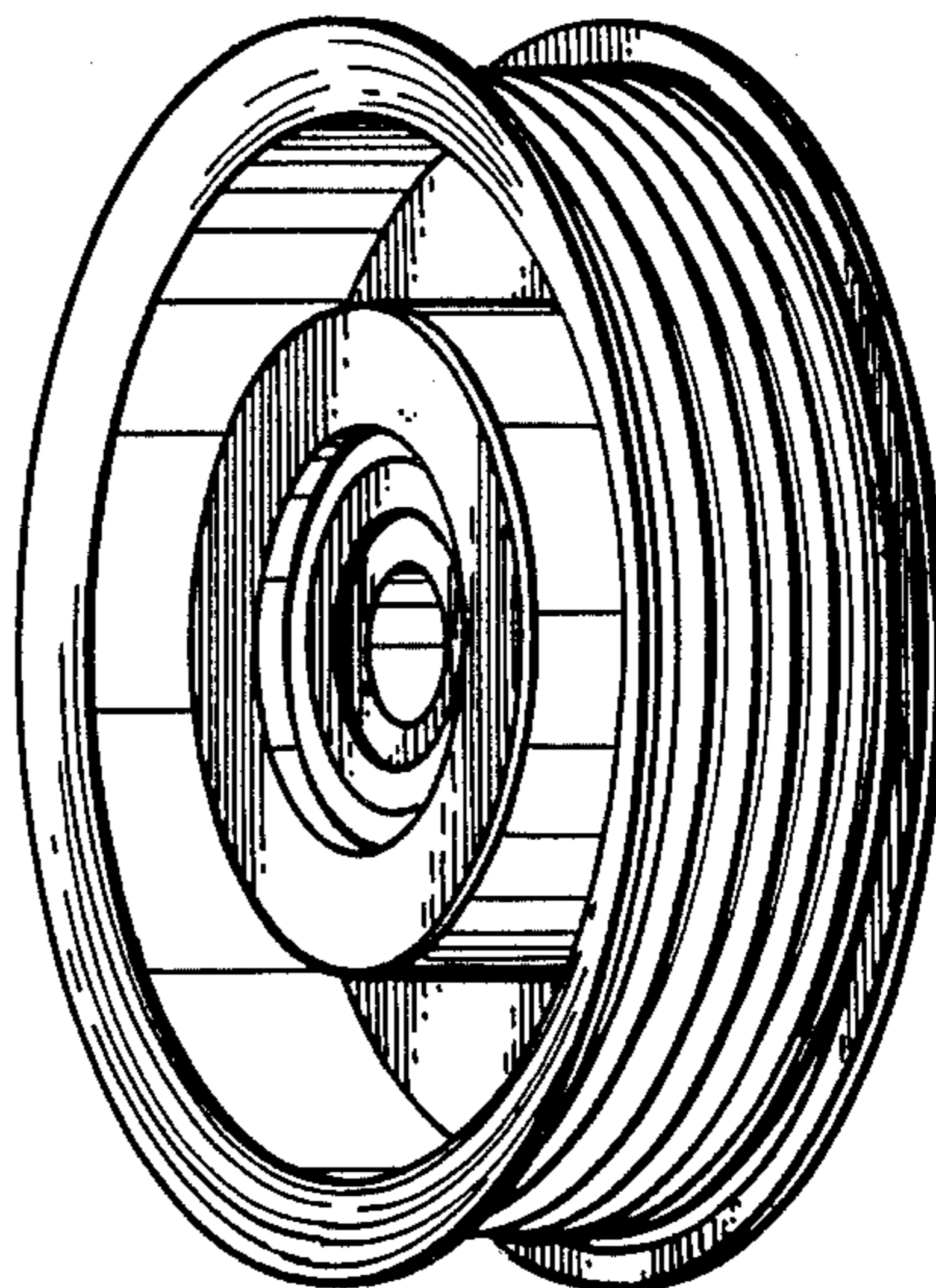

FIG. 14

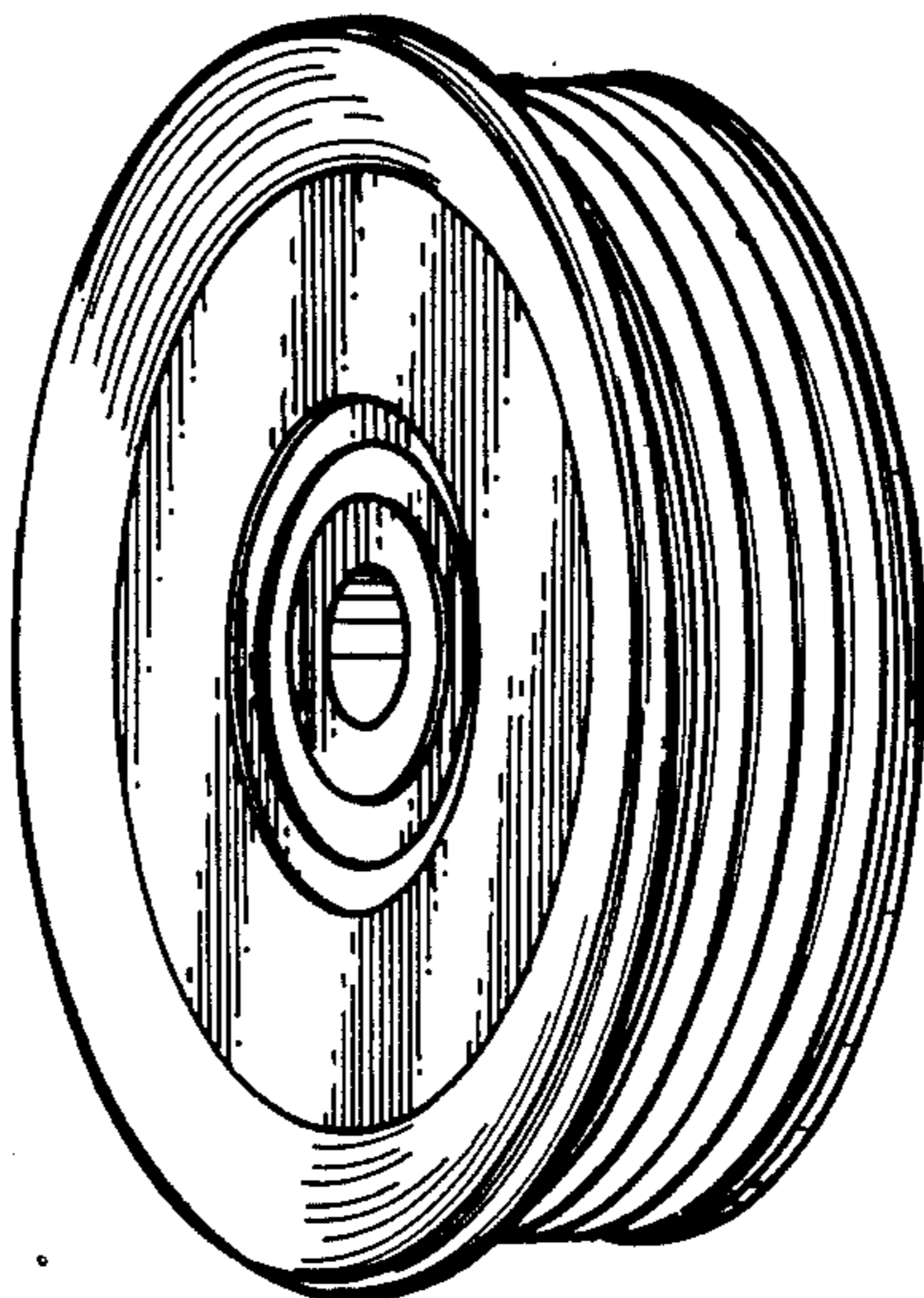

FIG. 15

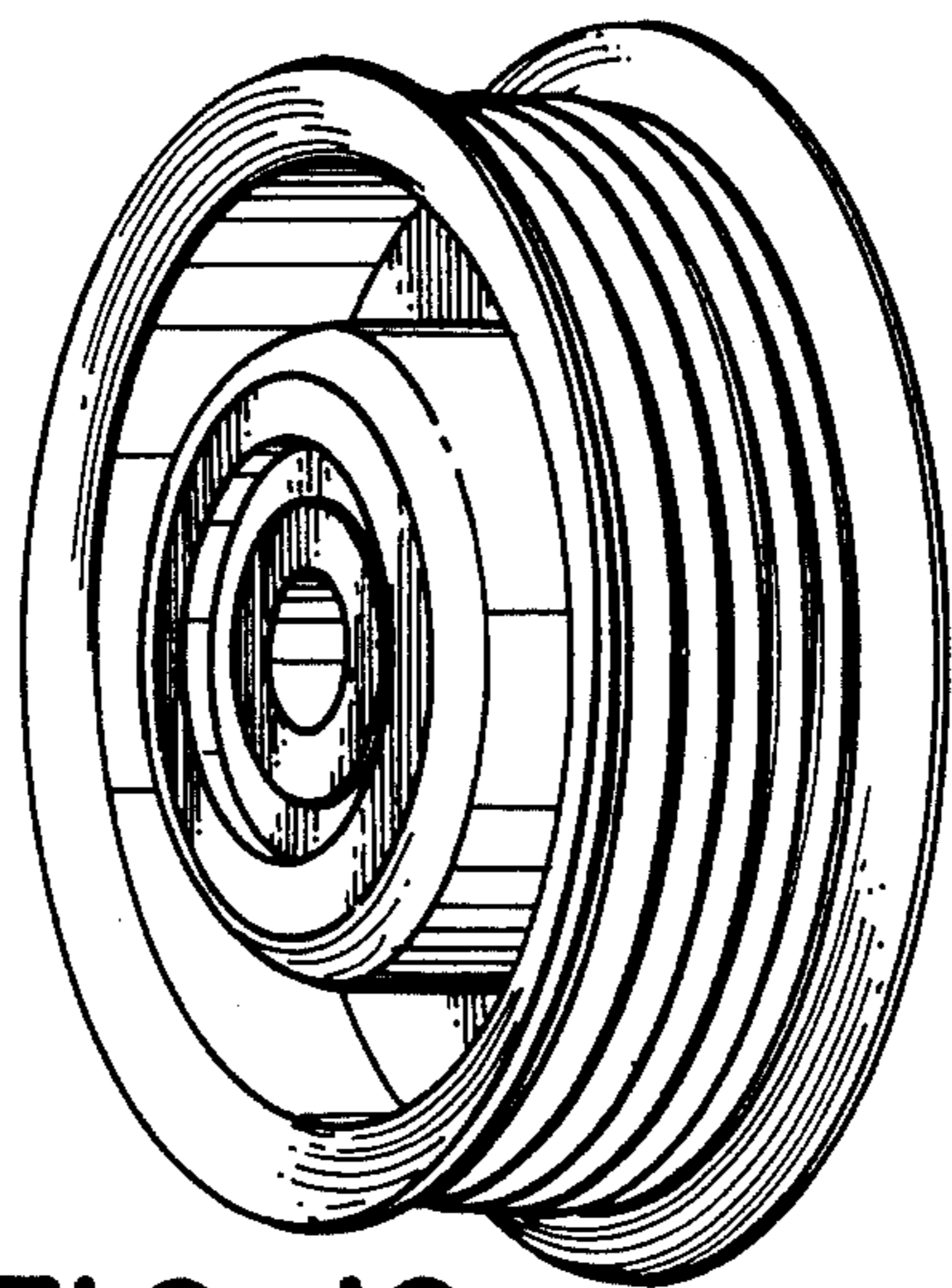

FIG. 16

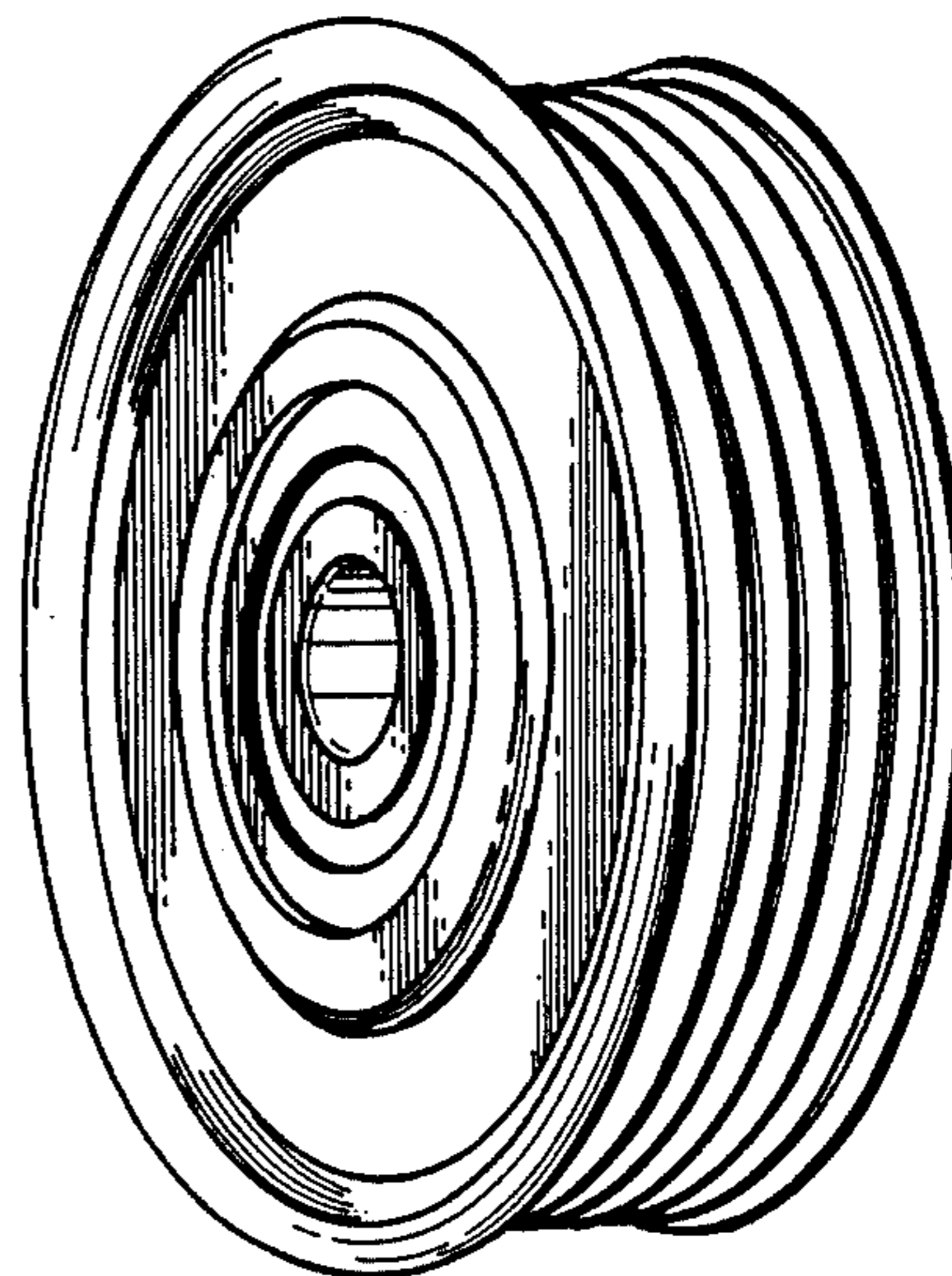

FIG. 17

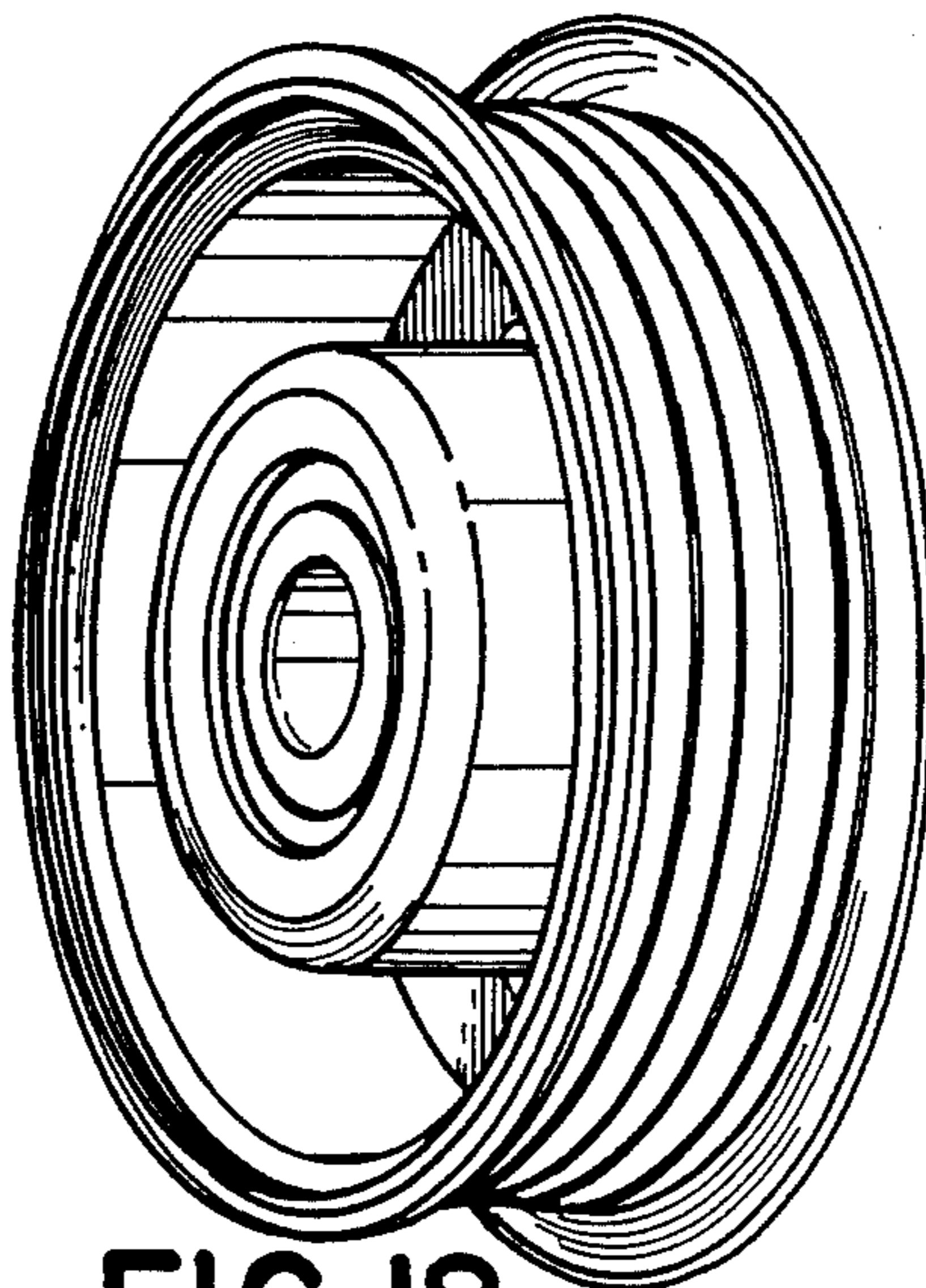

FIG. 18