

[54] CAGE FOR ANIMALS

3,556,038 1/1969 Smiler 119/17
3,896,766 7/1975 Martin 119/17
4,416,493 11/1983 Summer 119/17 X

[75] Inventor: Kazutoshi Tominaga, Higashi
Osakashi, Japan

Primary Examiner—James R. Largen

[73] Assignee: Kabushiki Kaisha Tominaga Jyushi
Kogyosho, Higashi, Japan

[57] CLAIM

[**] Term: 14 Years

The ornamental design for a cage for animals, as shown
and described.

[21] Appl. No.: 196,111

DESCRIPTION

[22] Filed: May 19, 1988

[52] U.S. Cl. D30/112

[58] Field of Search D30/102, 108-120,
D30/125, 160; 119/1, 17, 19, 23, 26, 29, 52.28,
58.7

FIG. 1 is a perspective view taken from the top, front
and left side of a cage for animals showing my new
design;

FIG. 2 is a front elevational view thereof, the rear being
the same as the front shown;

FIG. 3 is a top plan view thereof;

FIG. 4 is a right side elevational view thereof, the left
side being the same as the right side shown;

FIG. 5 is a bottom plan view thereof;

FIG. 6 is a cross sectional view taken on line 6-6 of
FIG. 3; and

FIG. 7 is an exploded perspective view thereof showing
the cage partially disassembled.

[56] References Cited

U.S. PATENT DOCUMENTS

- D. 187,534 3/1960 Benjamin, Jr. D30/112
- 2,778,333 1/1957 Babros et al. D30/116 X
- 3,195,505 7/1965 Hauth et al. 119/17
- 3,352,287 11/1967 Klingberg 119/17

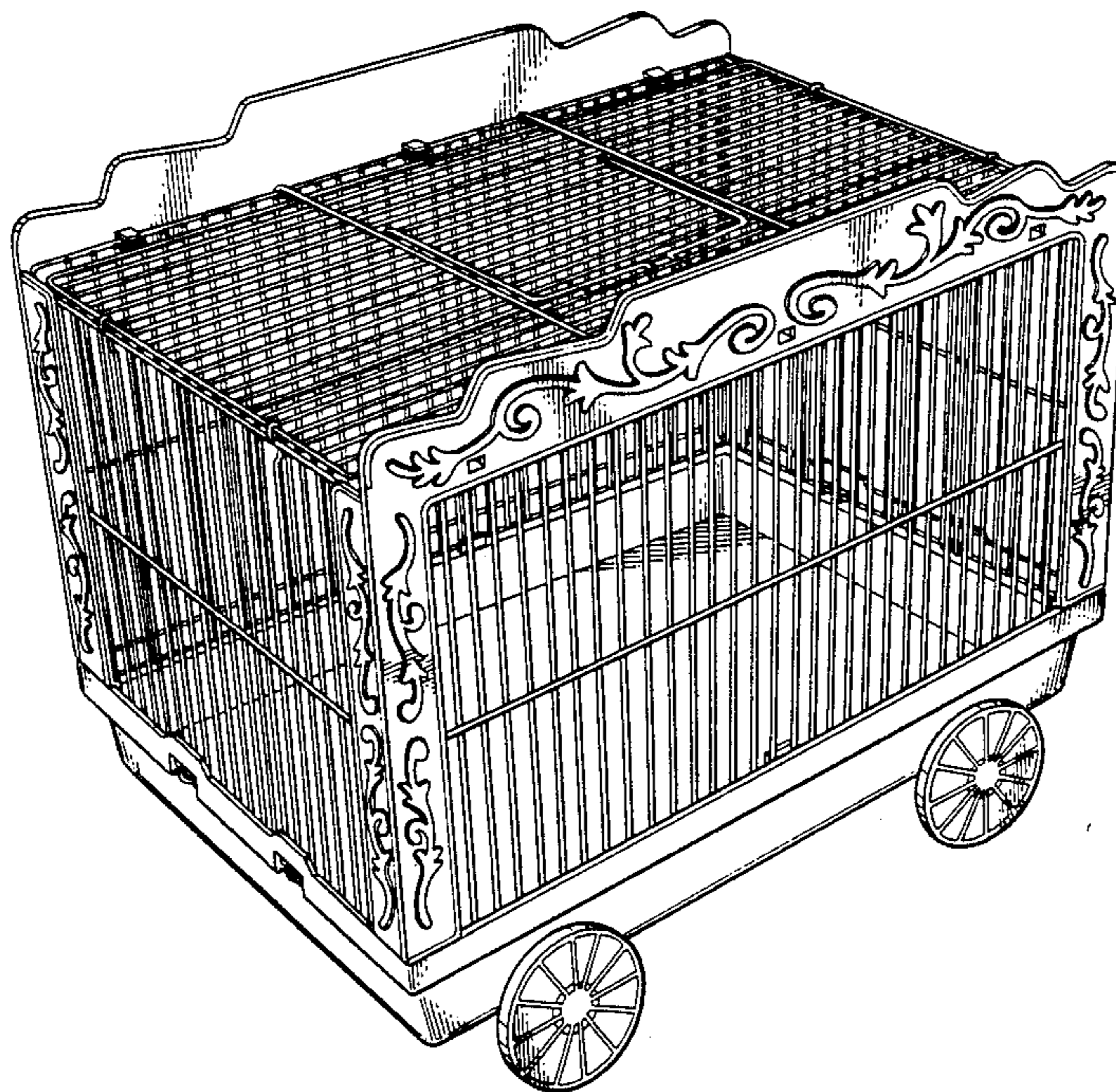

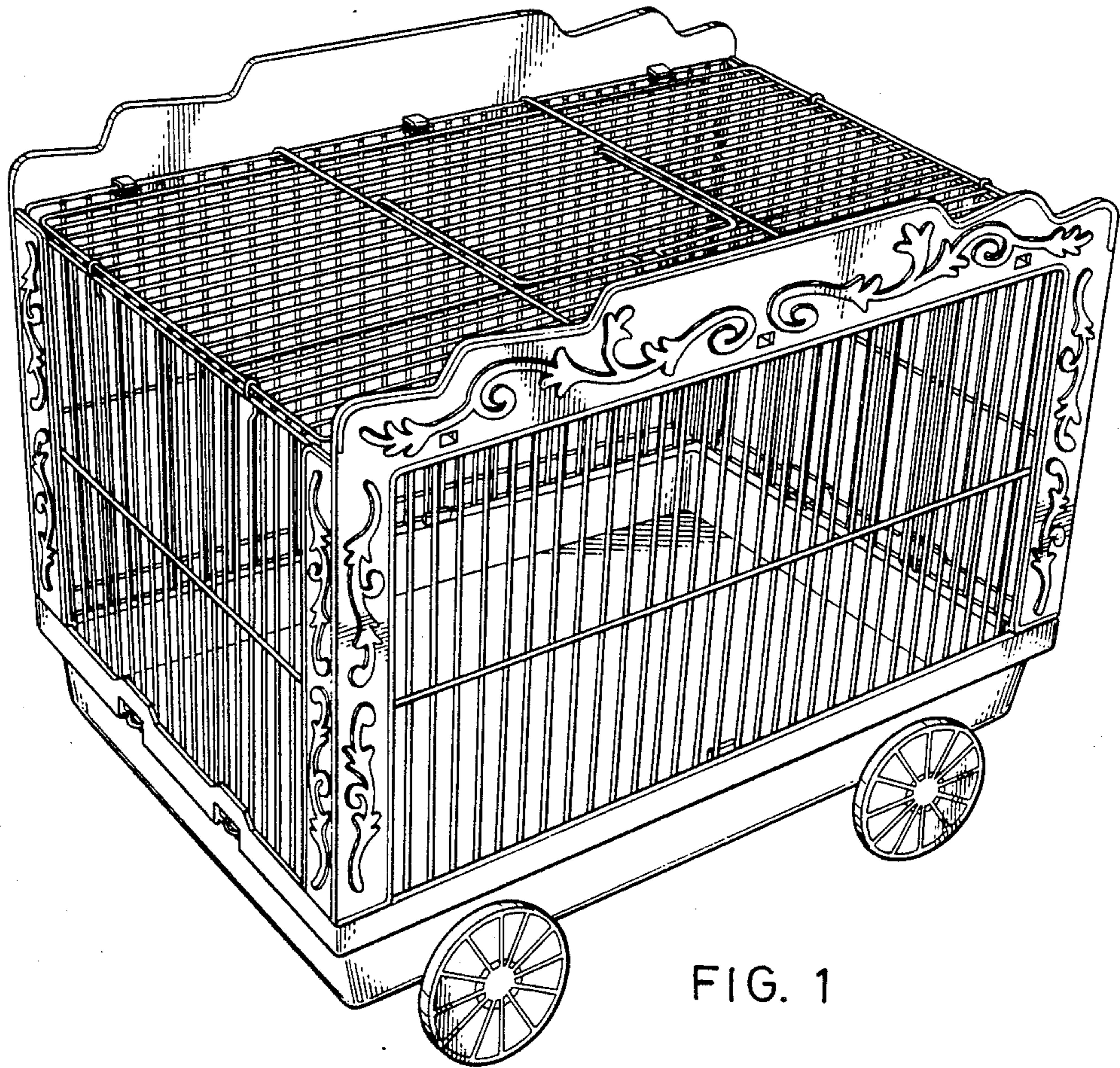

FIG. 1

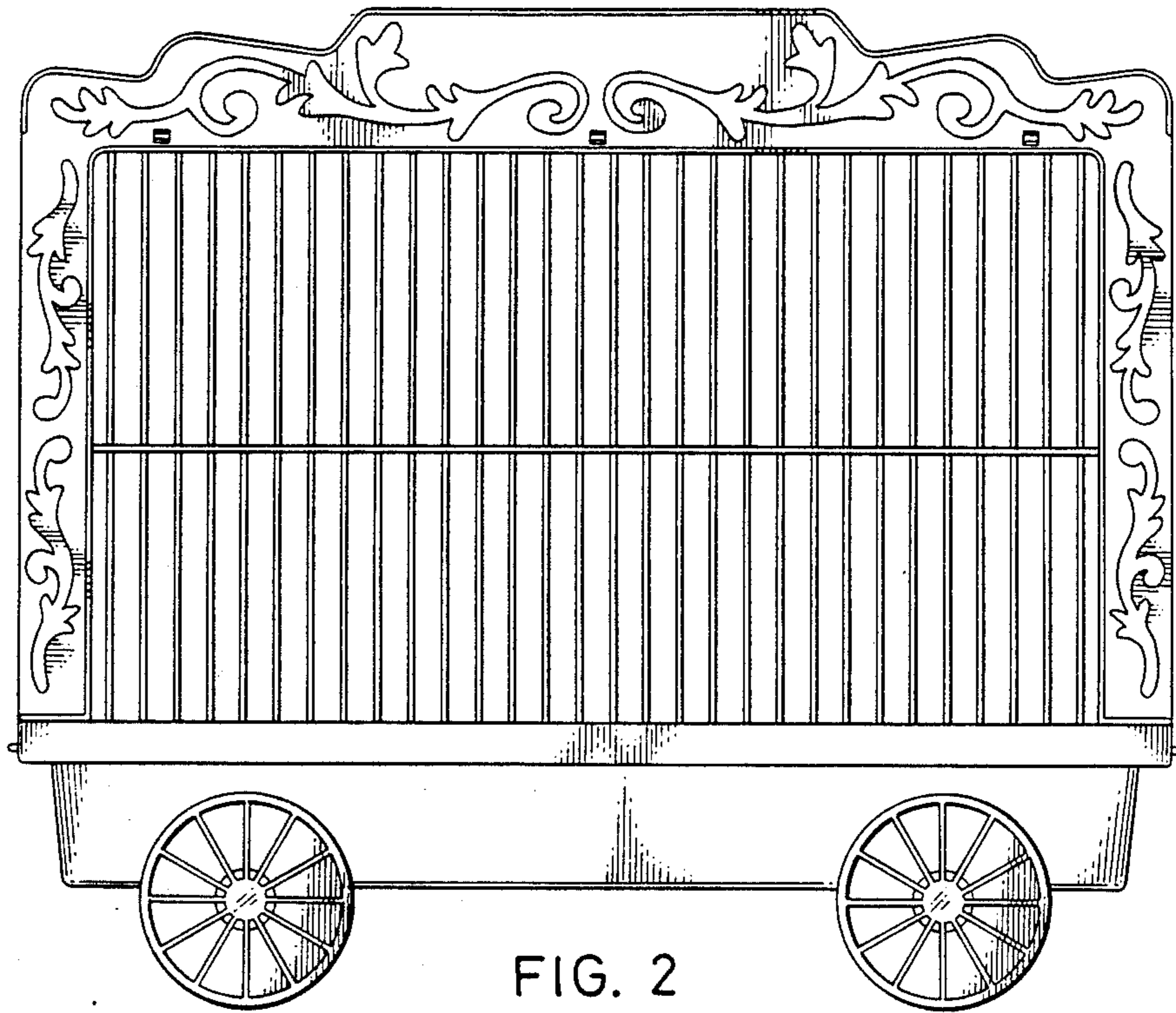

FIG. 2

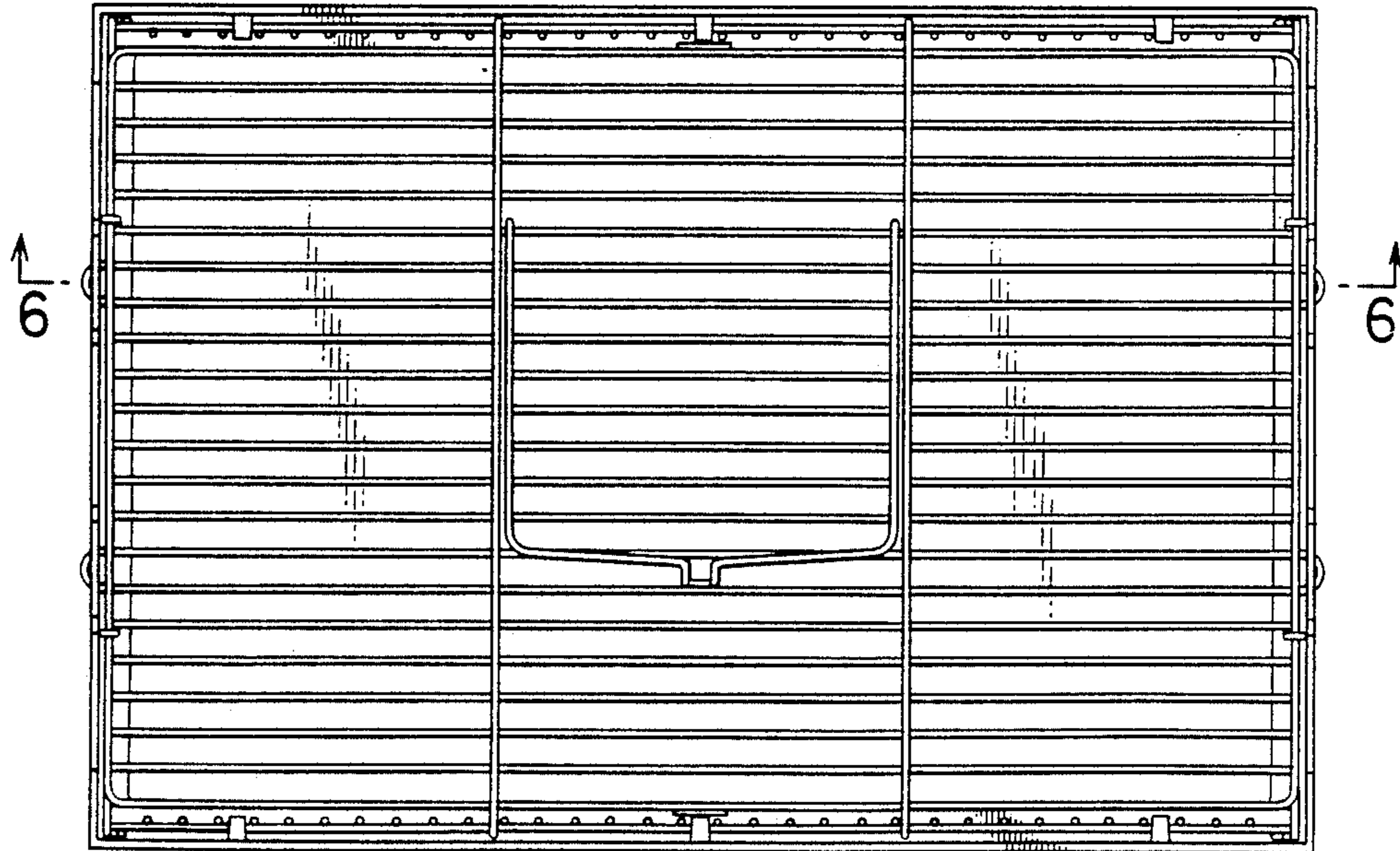

FIG. 3

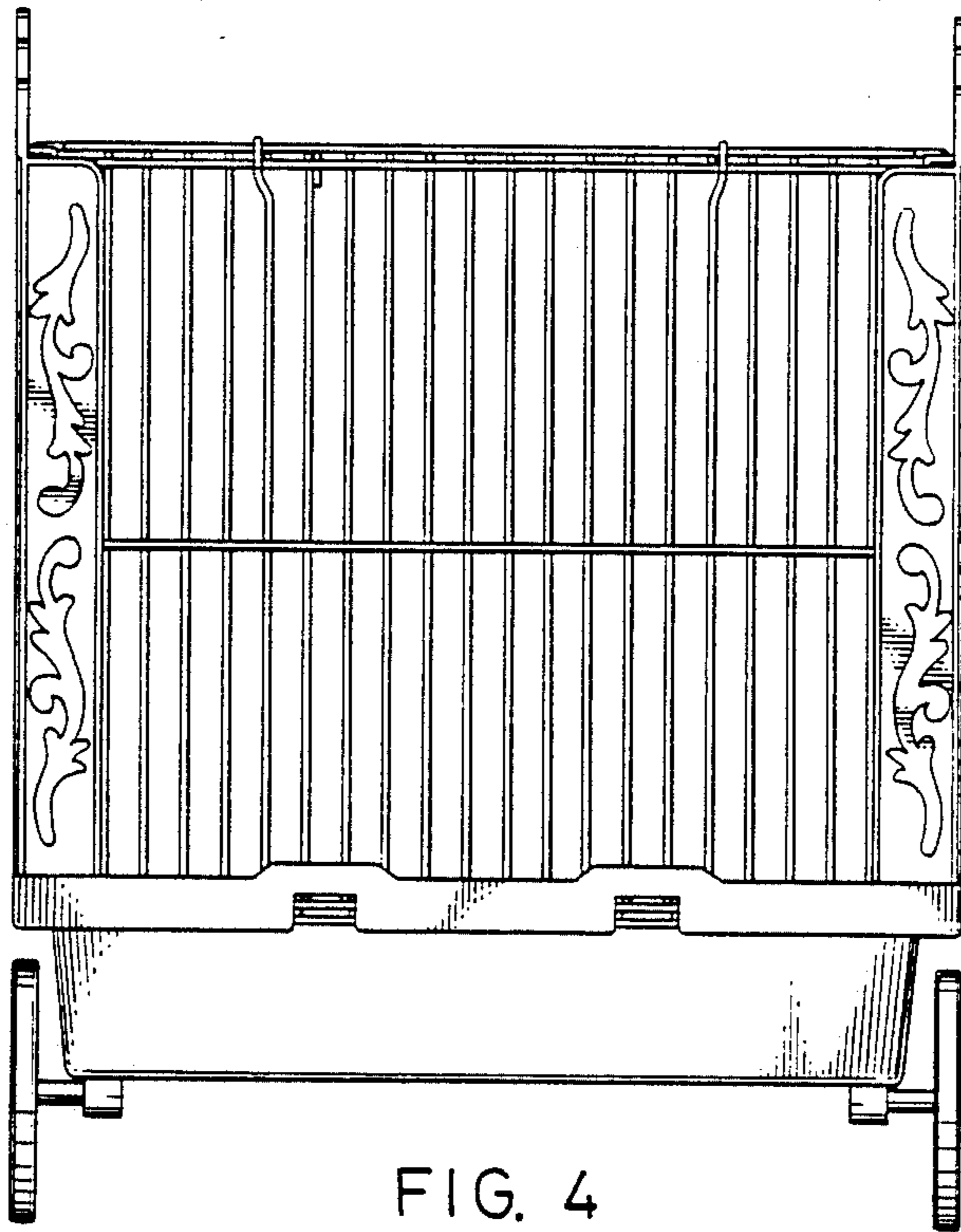

FIG. 4

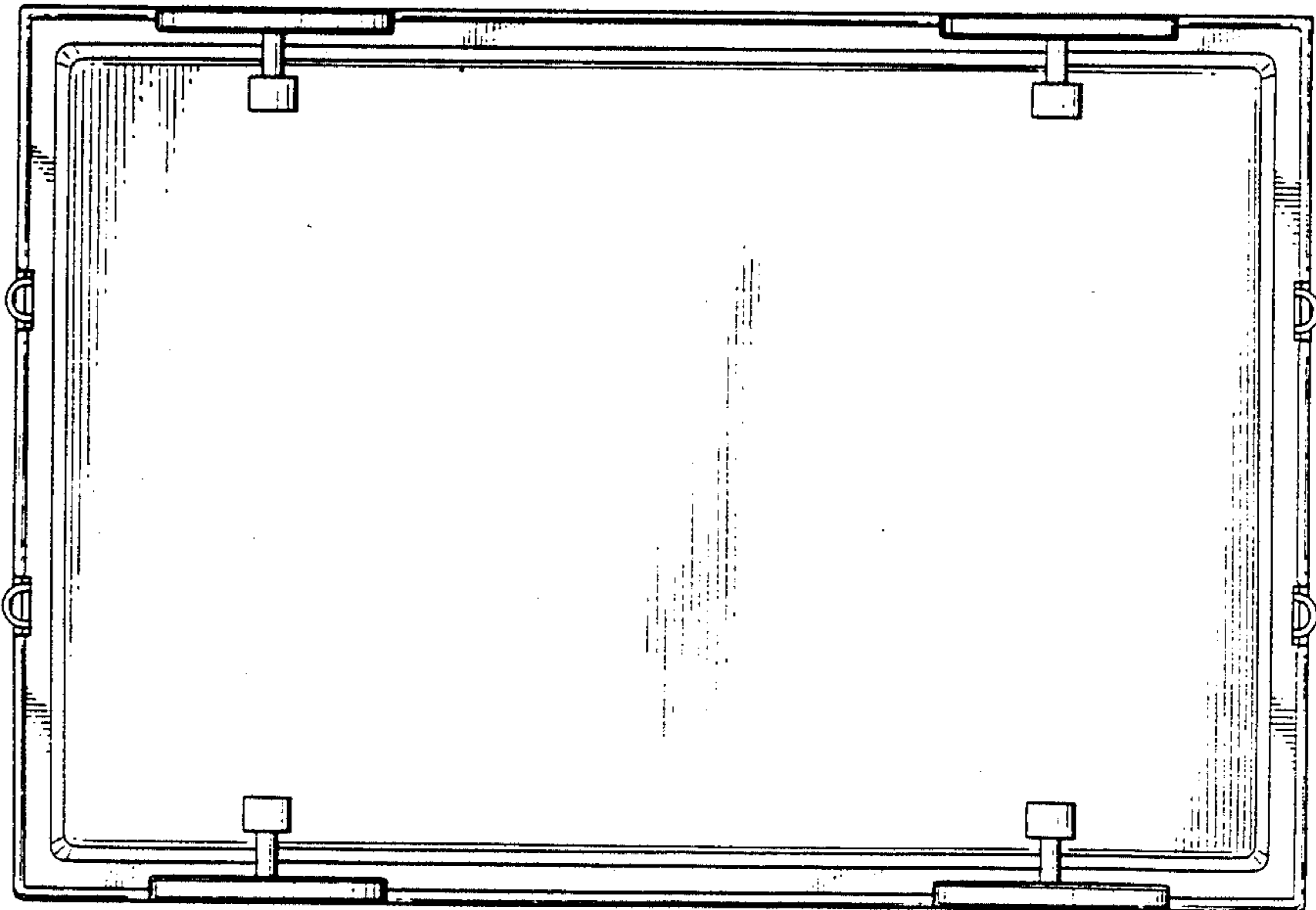

FIG. 5

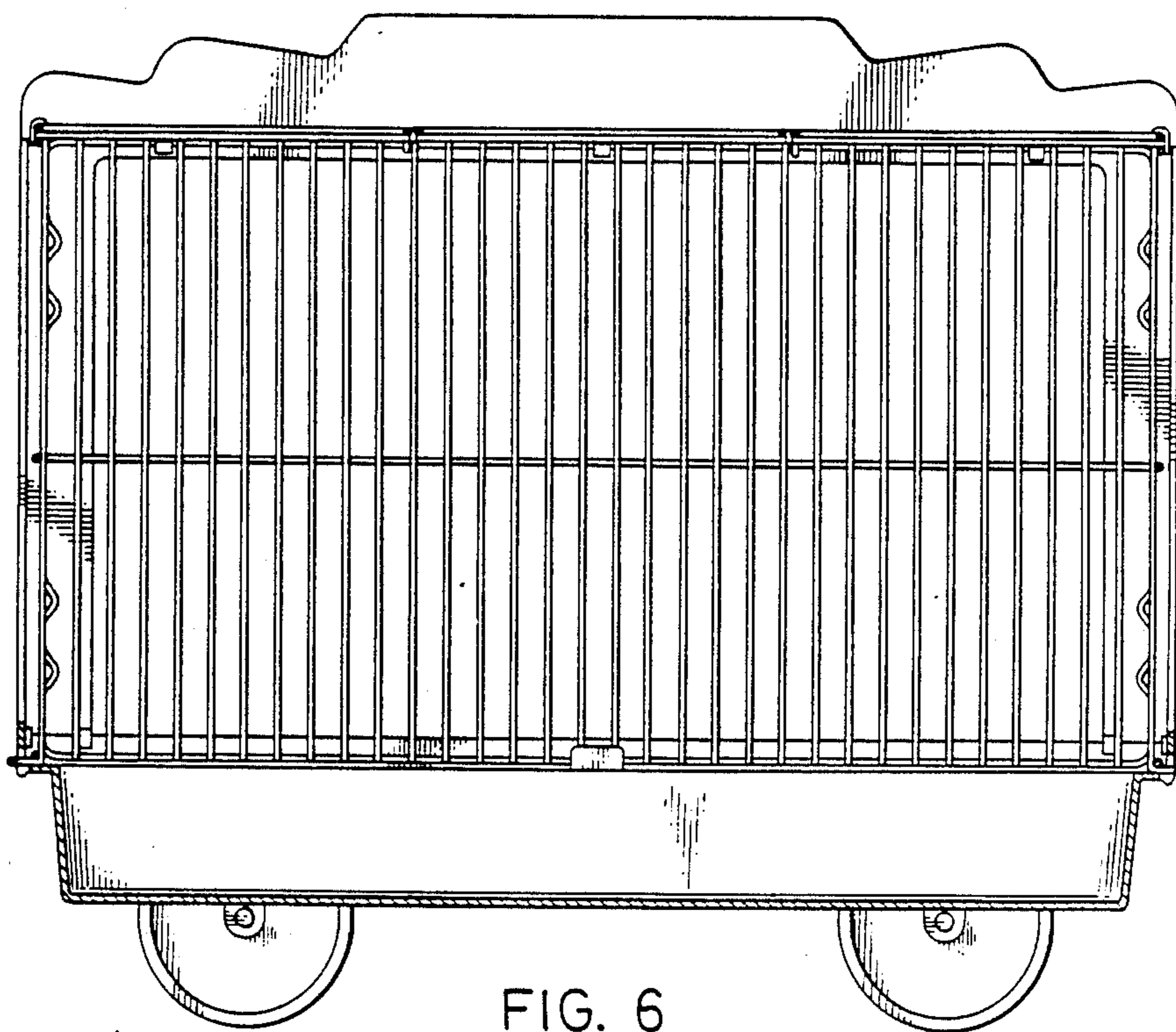

FIG. 6

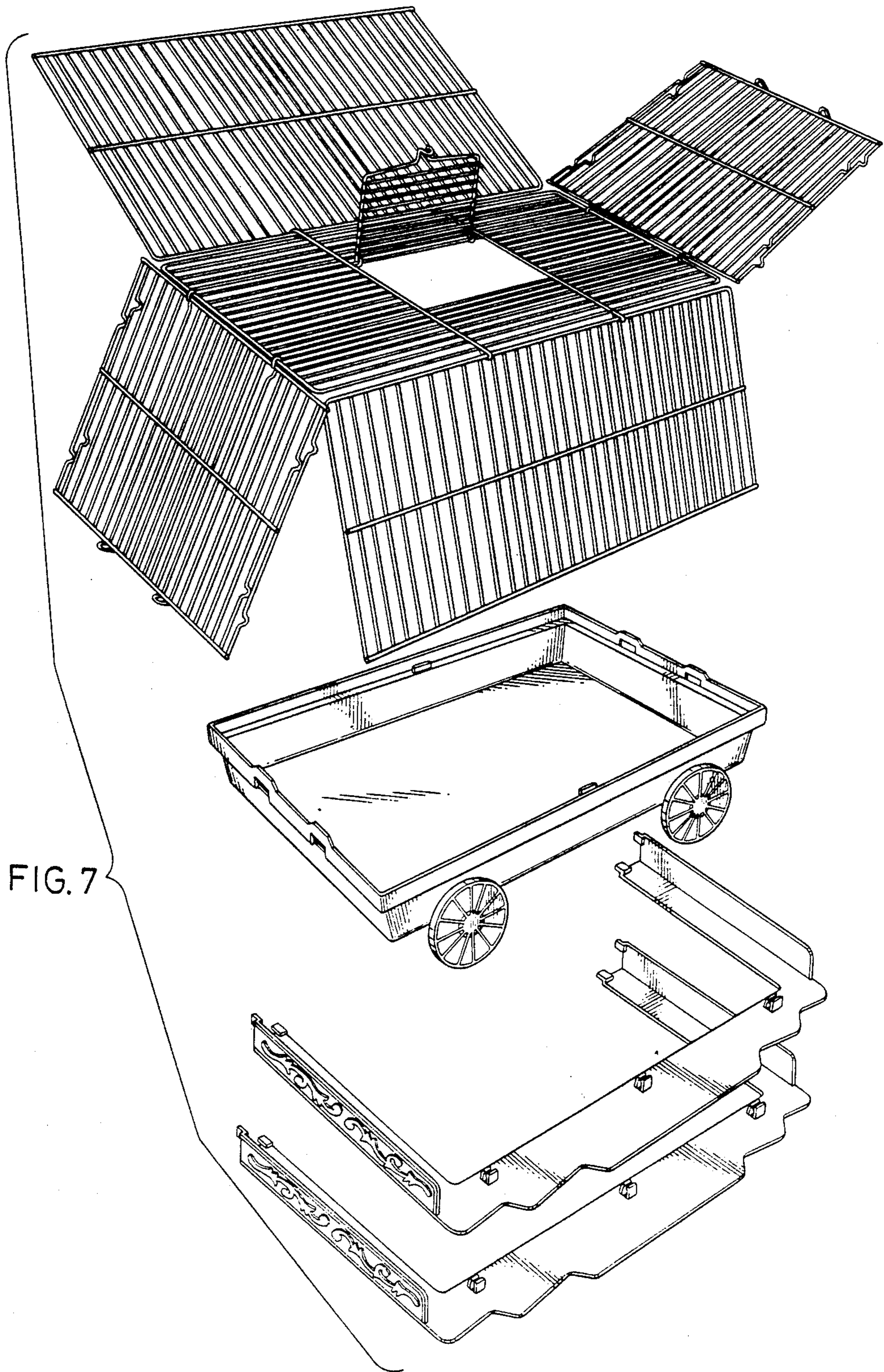

FIG. 7