

[54] TELEVISION SET

[75] Inventors: Ryunosuke Kitagawa; Osamu Shimizu, both of Osaka, Japan

[73] Assignee: Sharp Corporation, Osaka, Japan

[**] Term: 14 Years

[21] Appl. No.: 193,485

[22] Filed: May 11, 1988

[30] Foreign Application Priority Data

Nov. 17, 1987 [JP] Japan 62-47162
 [52] U.S. Cl. D14/126
 [58] Field of Search D14/125-134,
 D14/113, 299; 355/254, 255; 312/7.2

[56] References Cited

U.S. PATENT DOCUMENTS

D. 281,244	11/1985	Ohtsu	D14/126
D. 289,047	3/1987	Suzuki et al.	D14/132
D. 294,699	3/1988	Ohzu	D14/126
D. 294,700	3/1988	Sakuta	D14/126
D. 300,633	4/1989	Makino et al.	D14/131
4,639,225	1/1987	Washizuka	358/254 X

OTHER PUBLICATIONS

Popular Science; Jan. 1986; p. 65; Epson LCD Color TV.

Video Review; Aug. 1987; p. 29; bottom right-Toshiba LCD TV.

HFD; 12/7/87; p. 99; top right-Sharp LCD TV.

Primary Examiner—Bernard Ansher

Assistant Examiner—Theodore M. Shooman

Attorney, Agent, or Firm—Flehr, Hohbach, Test, Albritton & Herbert

[57] CLAIM

The ornamental design for a television set, as shown and described.

DESCRIPTION

FIG. 1 is a front elevational view of a television set showing our new design;

FIG. 2 is a rear elevational view thereof;

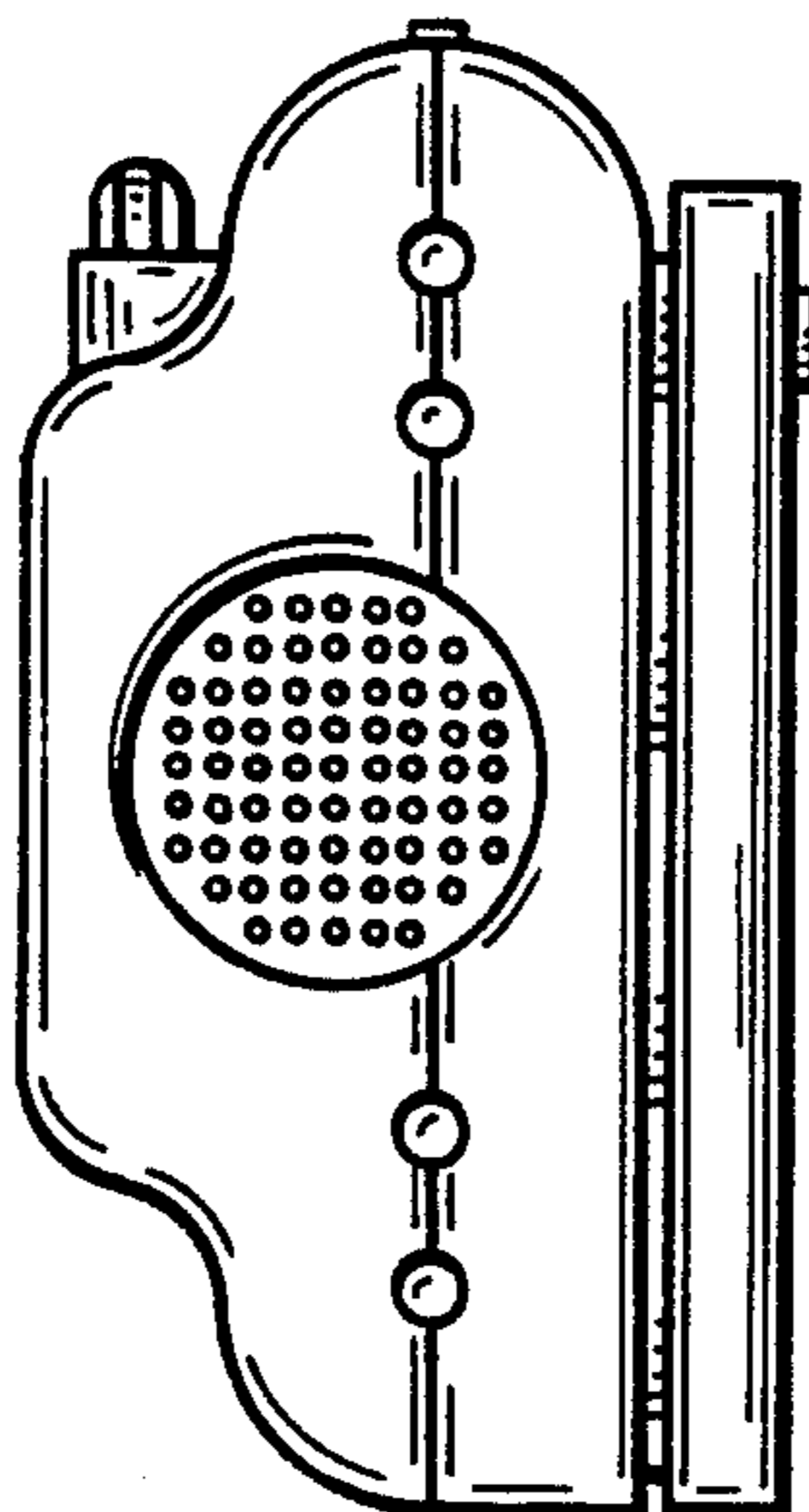
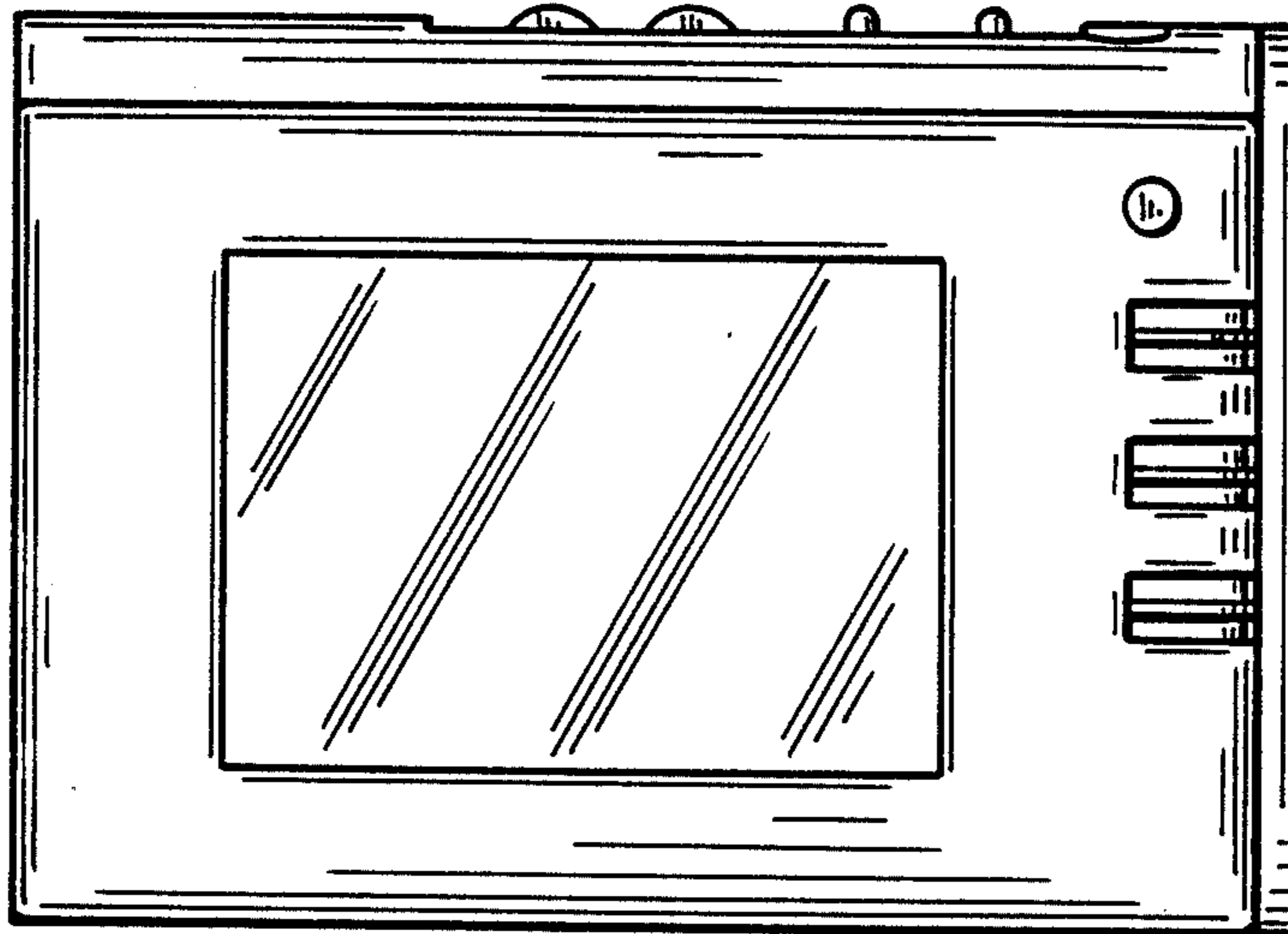
FIG. 3 is a top plan view thereof;

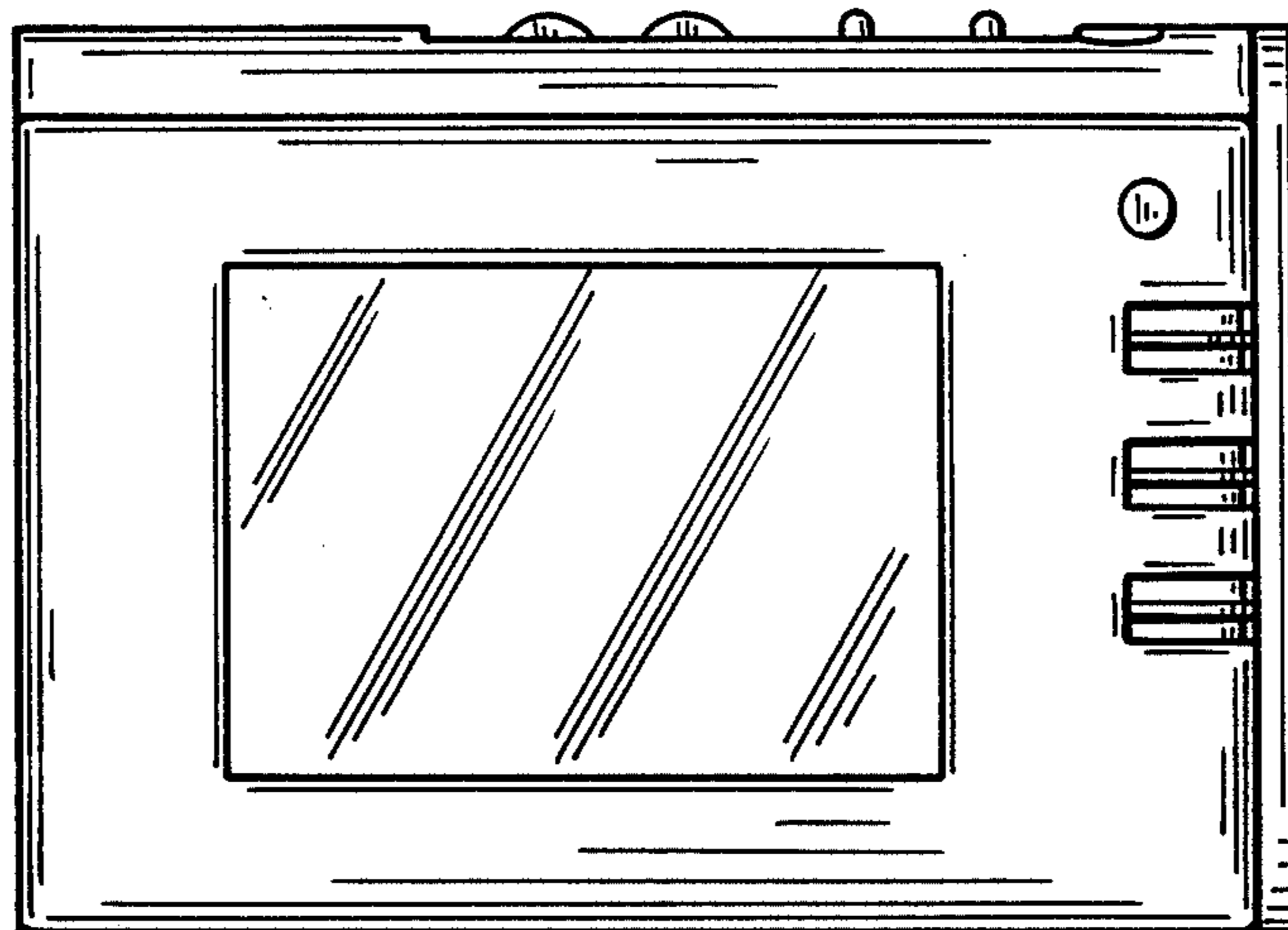
FIG. 4 is a bottom plan view thereof;

FIG. 5 is a right side elevational view thereof;

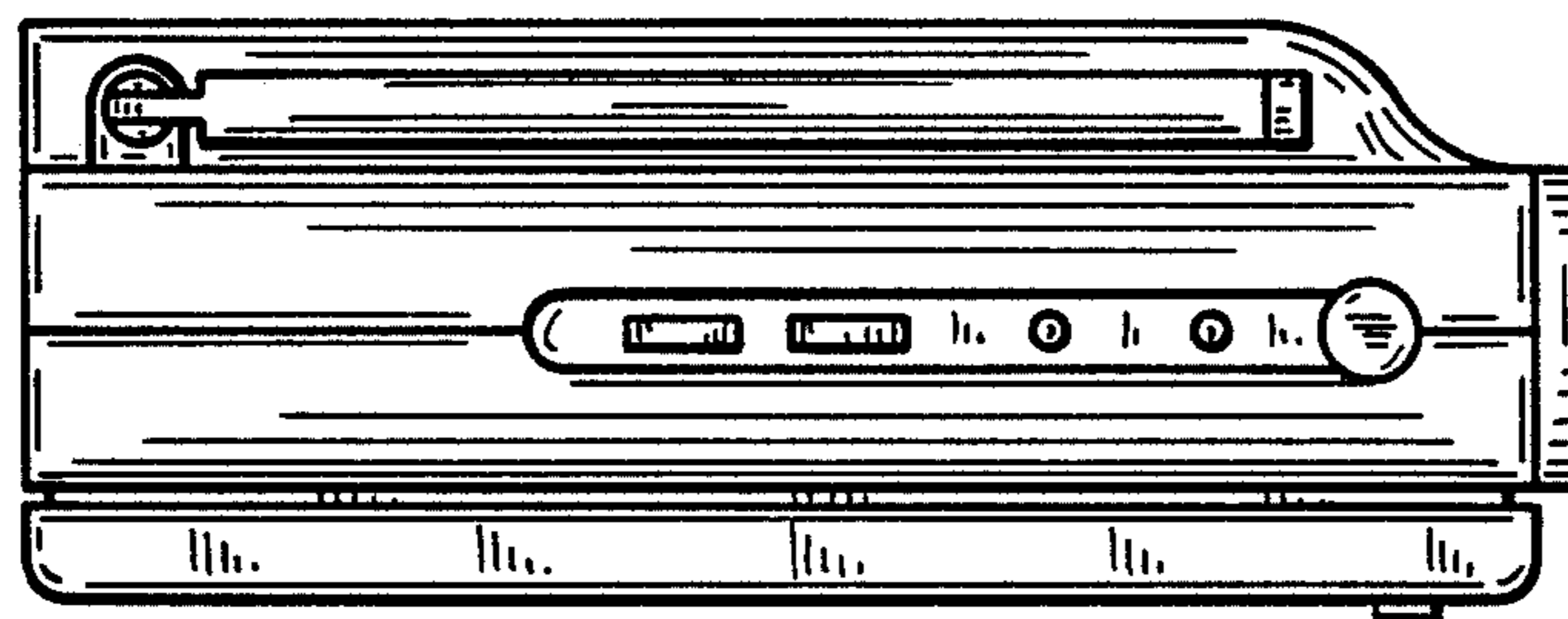
FIG. 6 is a left side elevational view thereof; and

FIG. 7 is a right side elevational view with the stand extended.

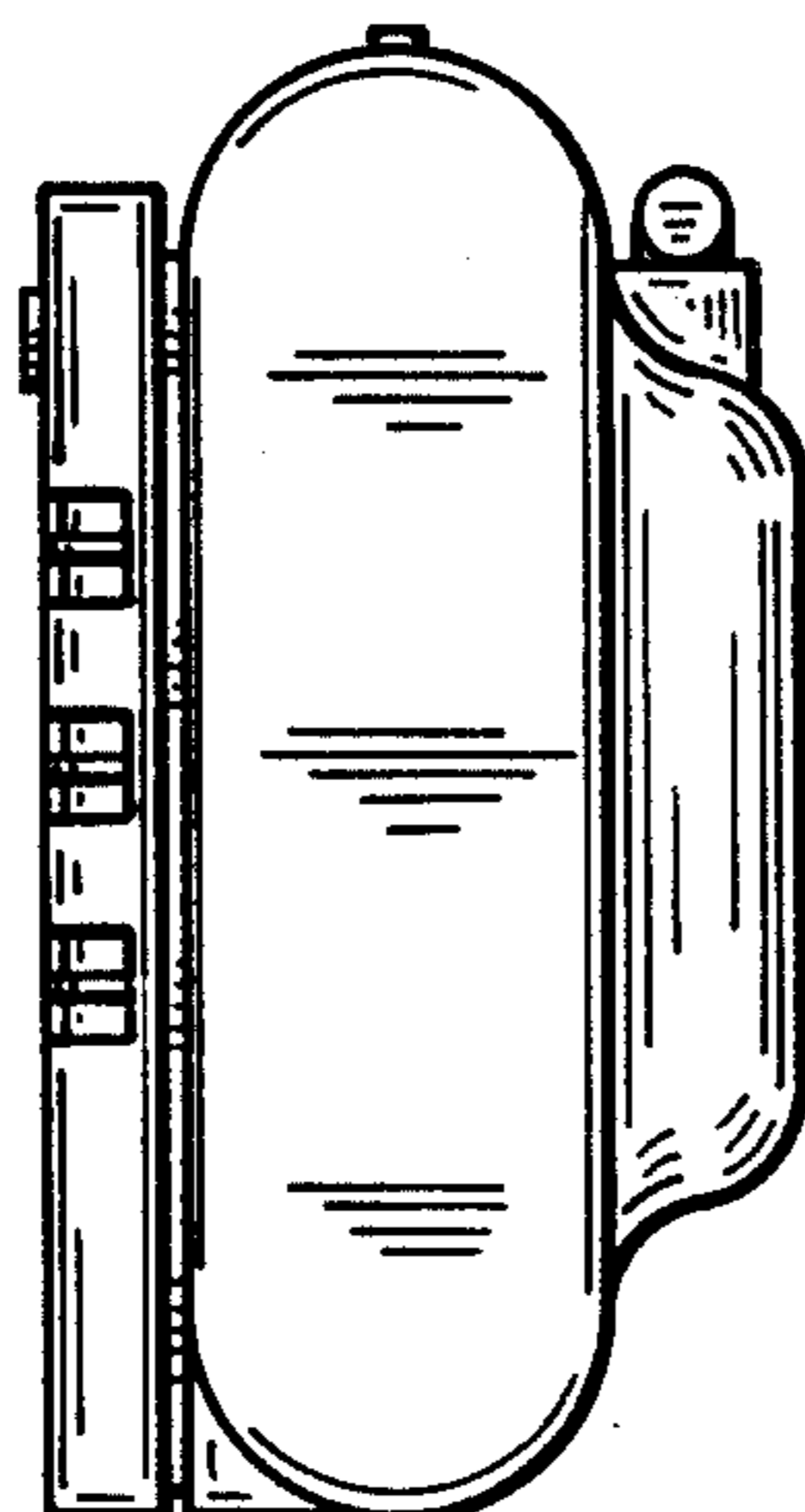




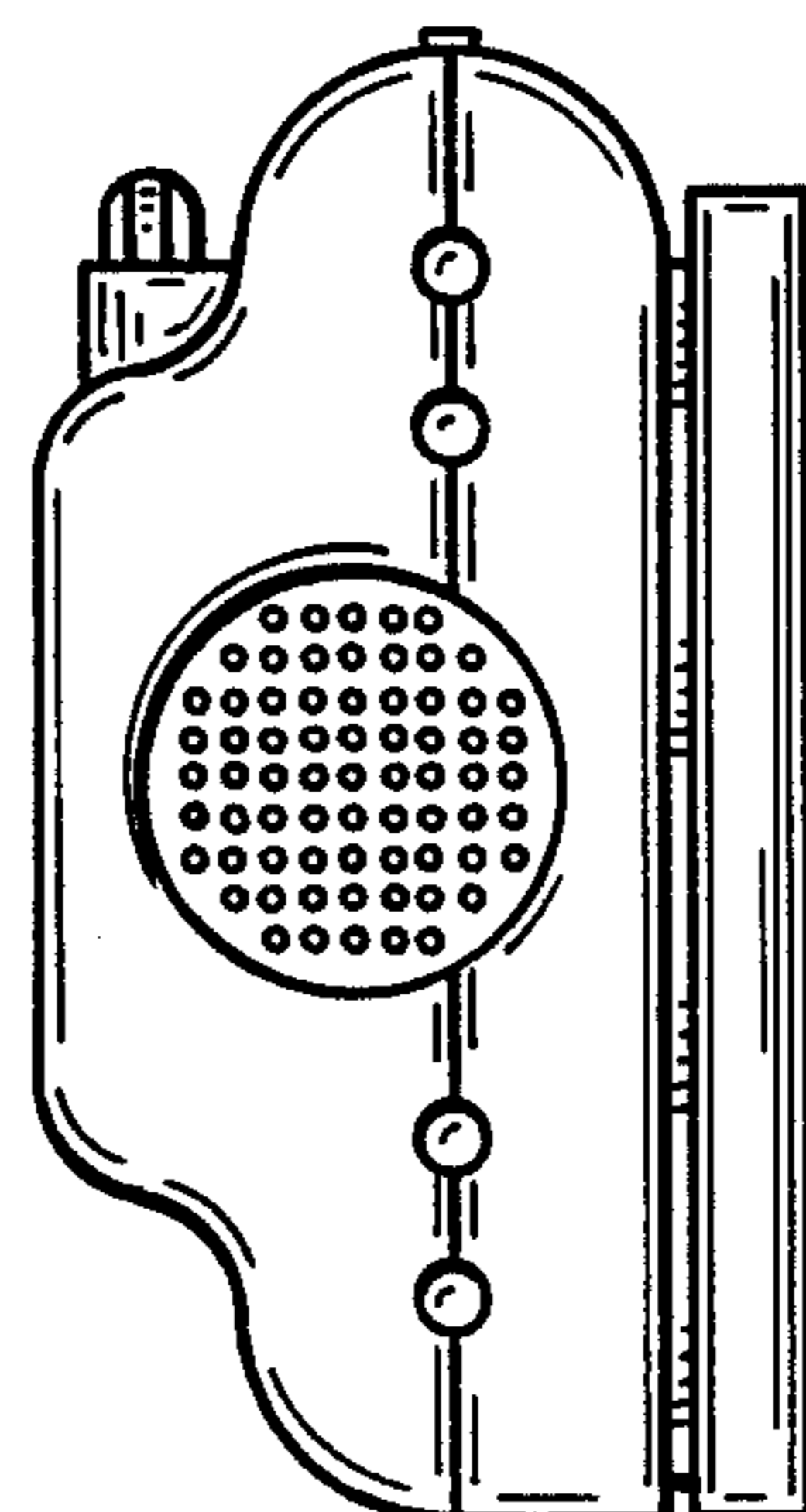
FIG_1



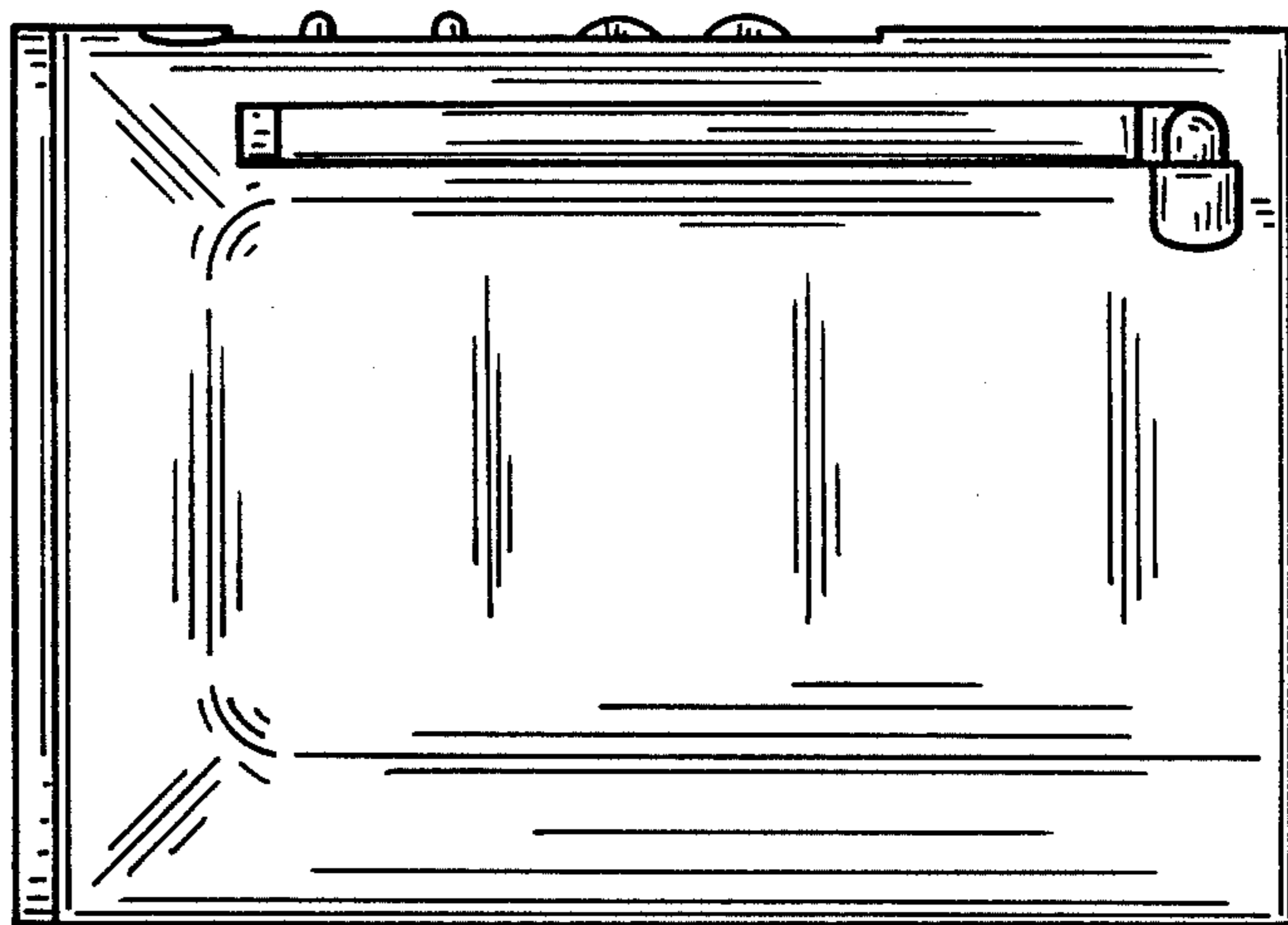
FIG_3



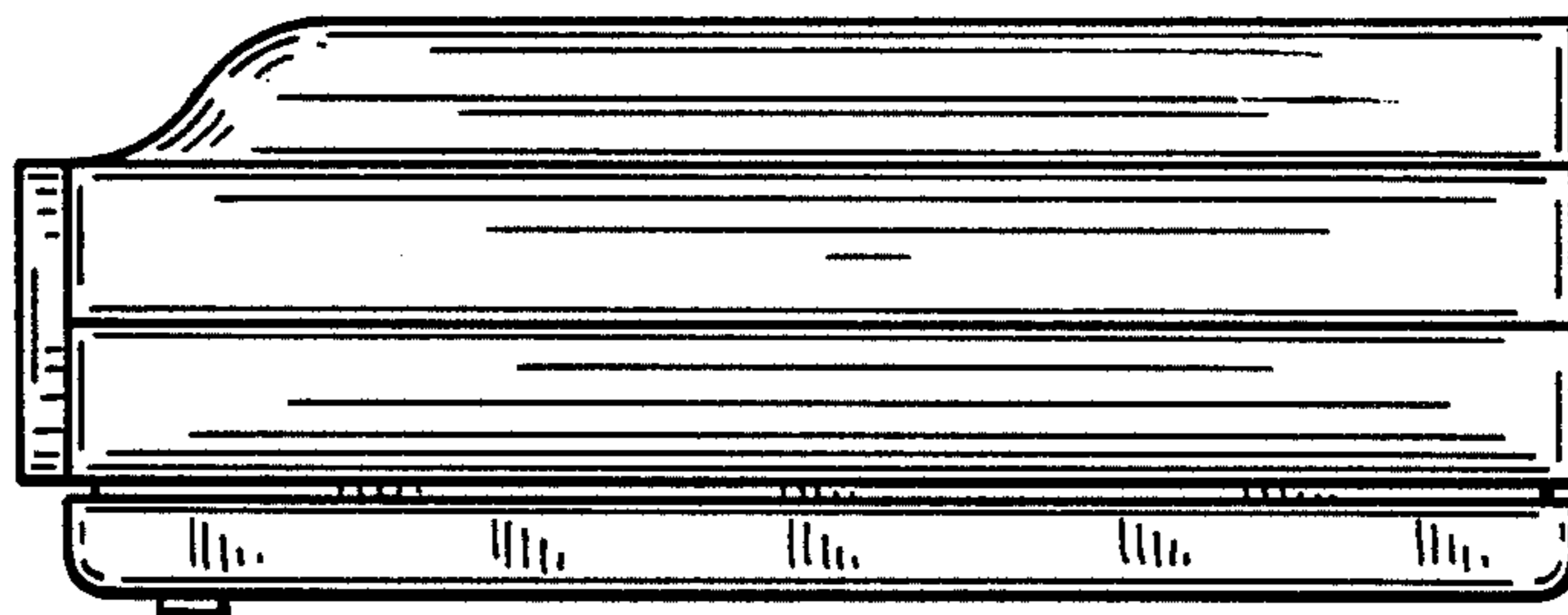
FIG_5



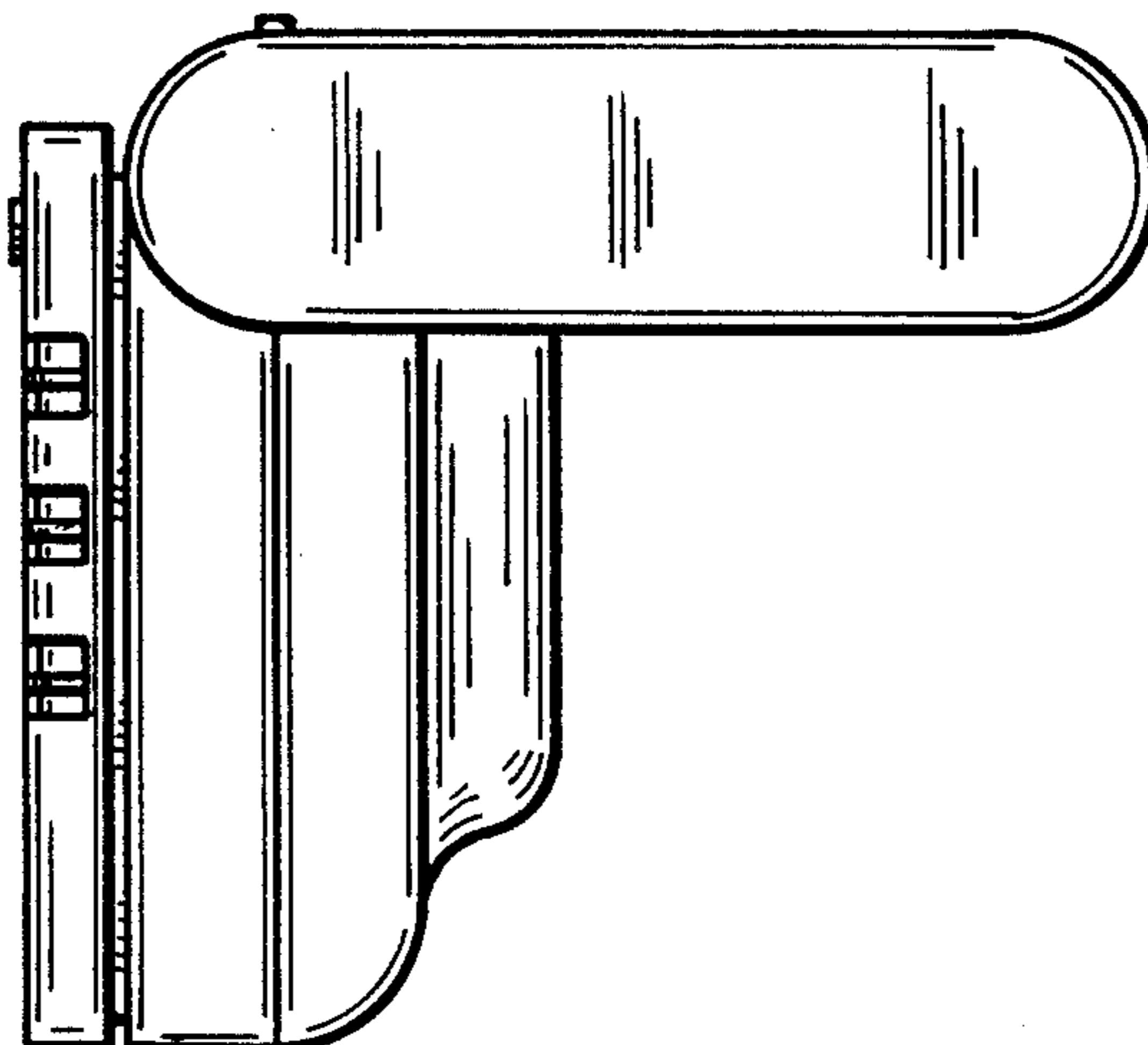
FIG_6



FIG_2



FIG_4



FIG_7