

[54] **RECEPTACLE PLUG COMBINATION**

[75] **Inventor: Douglas Hyde, Nepean, Canada**

[73] **Assignee: Electec, Ltd., Ontario, Canada**

[**] **Term: 14 Years**

[21] **Appl. No.: 866,300**

[22] **Filed: May 23, 1986**

[30] **Foreign Application Priority Data**

Nov. 26, 1985 [CA] Canada 26-11-85-1

[52] **U.S. Cl. D13/139**

[58] **Field of Search D13/11, 12, 18-24,
D13/40; 439/502, 677, 679, 925, 135, 136, 138,
578, 264, 259, 60, 63, 92, 404, 692, 628**

[56] **References Cited**

U.S. PATENT DOCUMENTS

D. 77,736 2/1929 Both D13/24
D. 91,940 4/1934 Hollingsworth D13/30

FOREIGN PATENT DOCUMENTS

0052591 8/1921 Switzerland 439/677
0619329 3/1949 United Kingdom 439/628

Primary Examiner—Bruce W. Dunkins

Assistant Examiner—Clare E. Heflin

Attorney, Agent, or Firm—Pollock, Vande Sande & Priddy

[57] **CLAIM**

The ornamental design for a receptacle-plug combination, as shown and described.

DESCRIPTION

FIG. 1 is a rear elevational view of the receptacle-plug combination showing my new design, the three wires being shown broken away to depict indeterminate length;

FIG. 2 is a front elevational view thereof;

FIG. 3 is a side elevational view thereof;

FIG. 4 is a top plan view thereof;

FIG. 5 is a bottom plan view thereof;

FIG. 6 is an opposite side elevational view thereof.

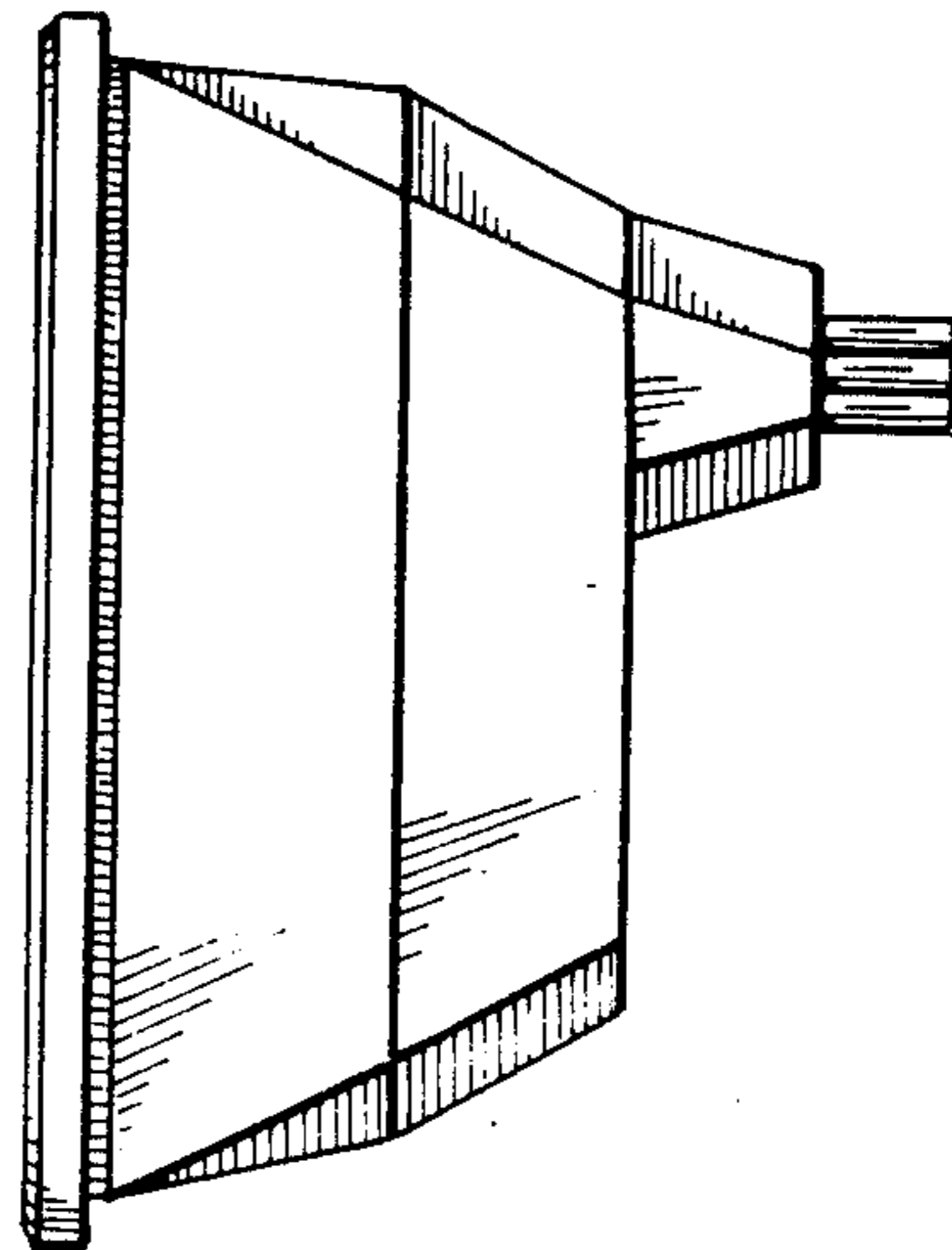
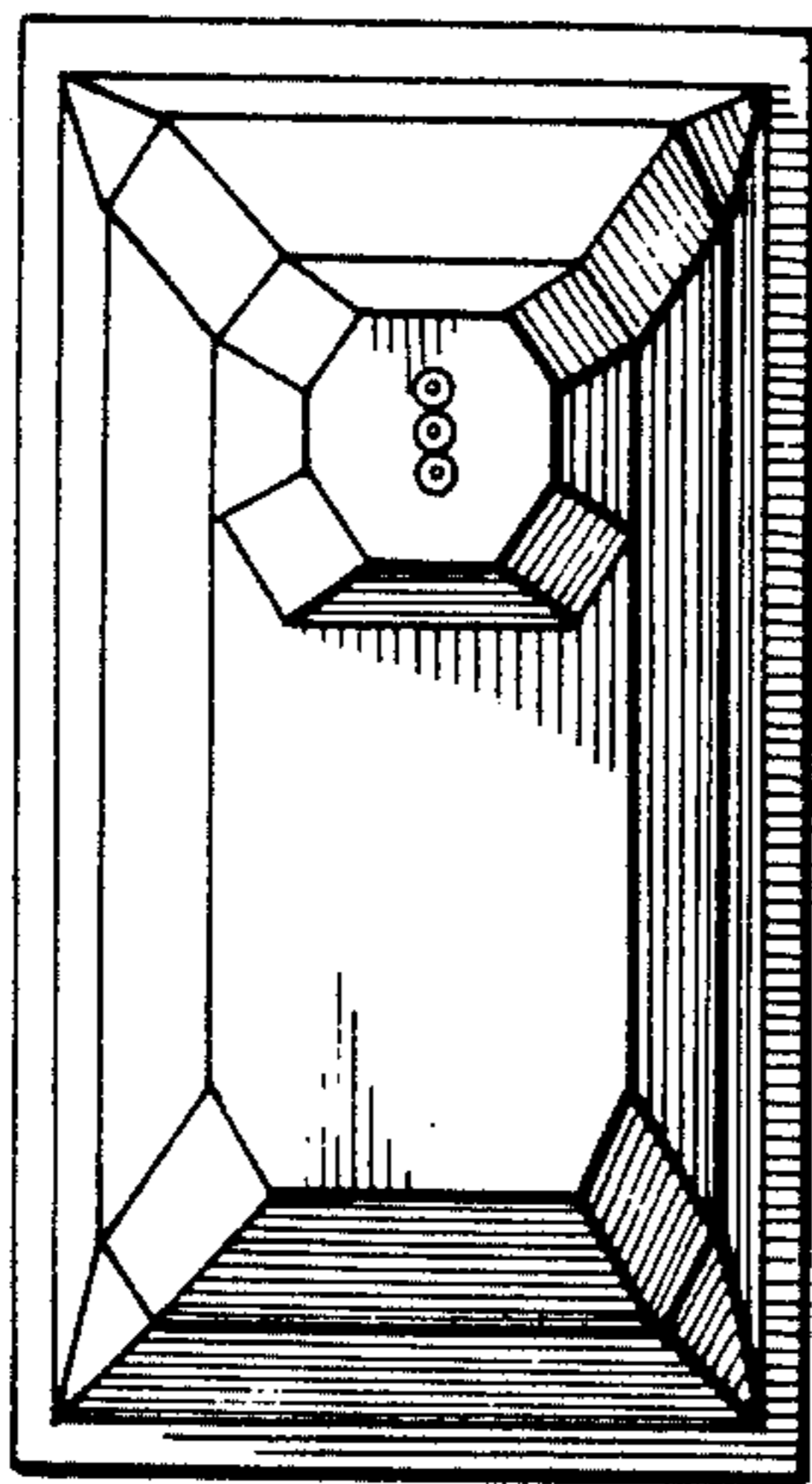

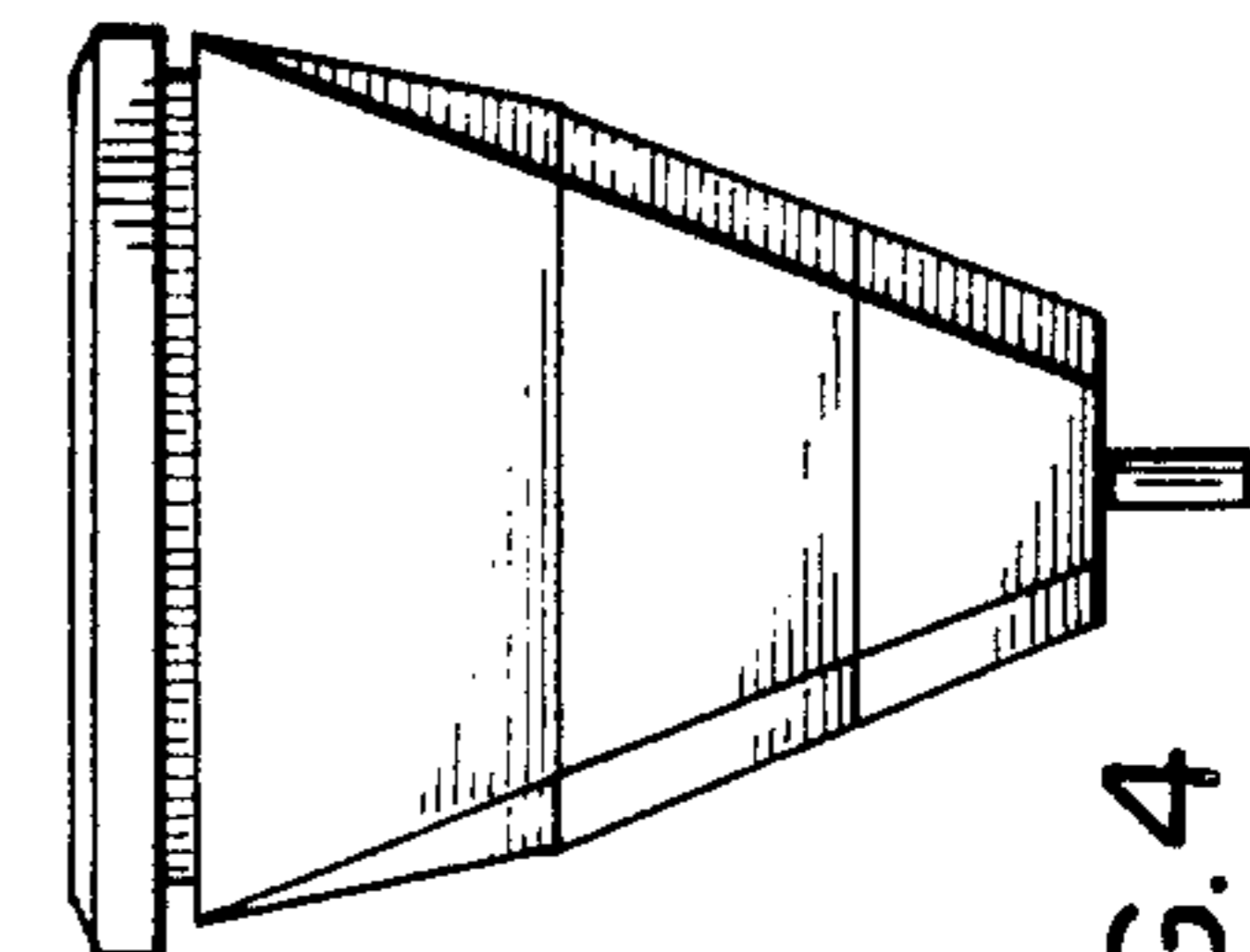
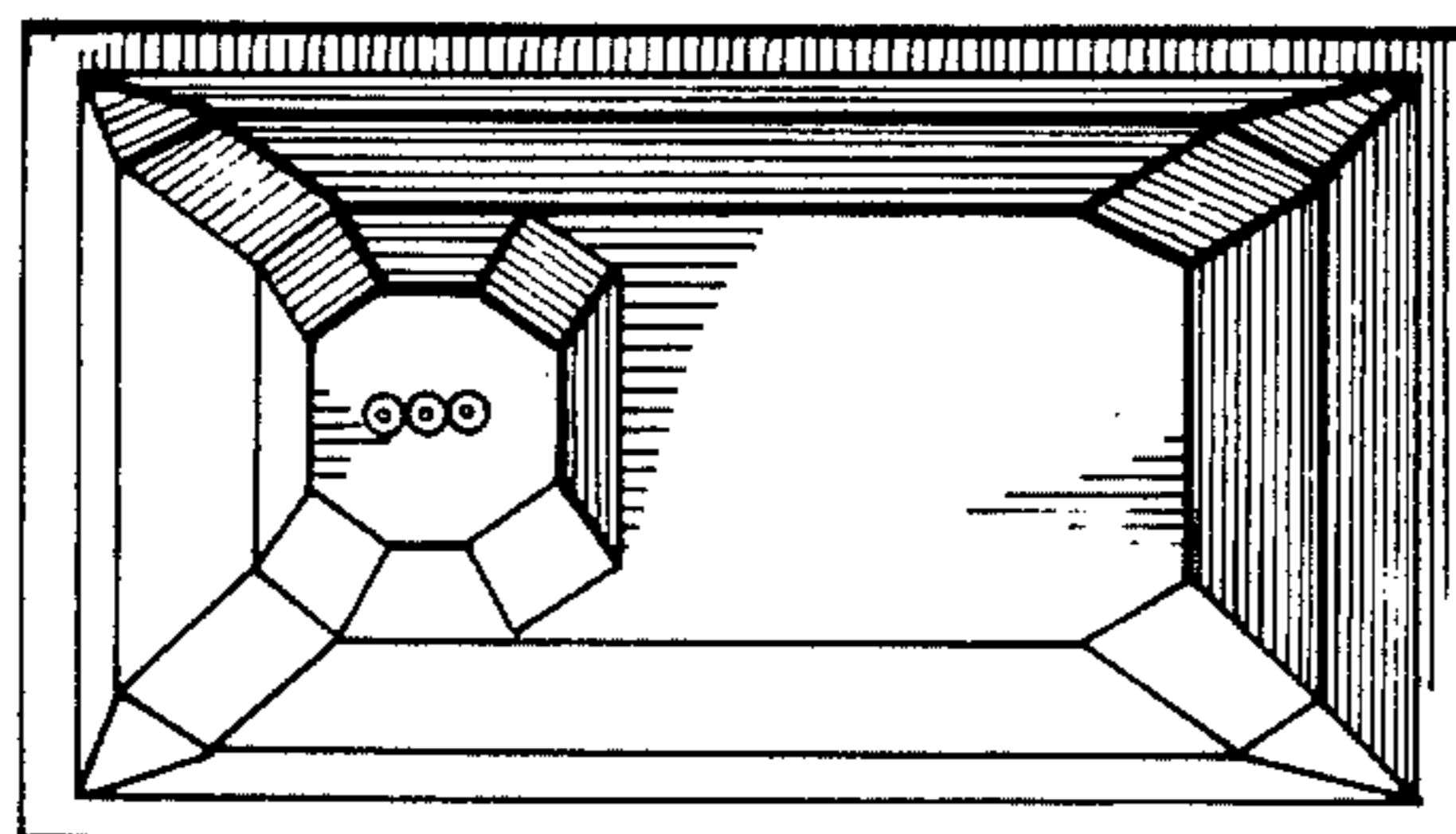
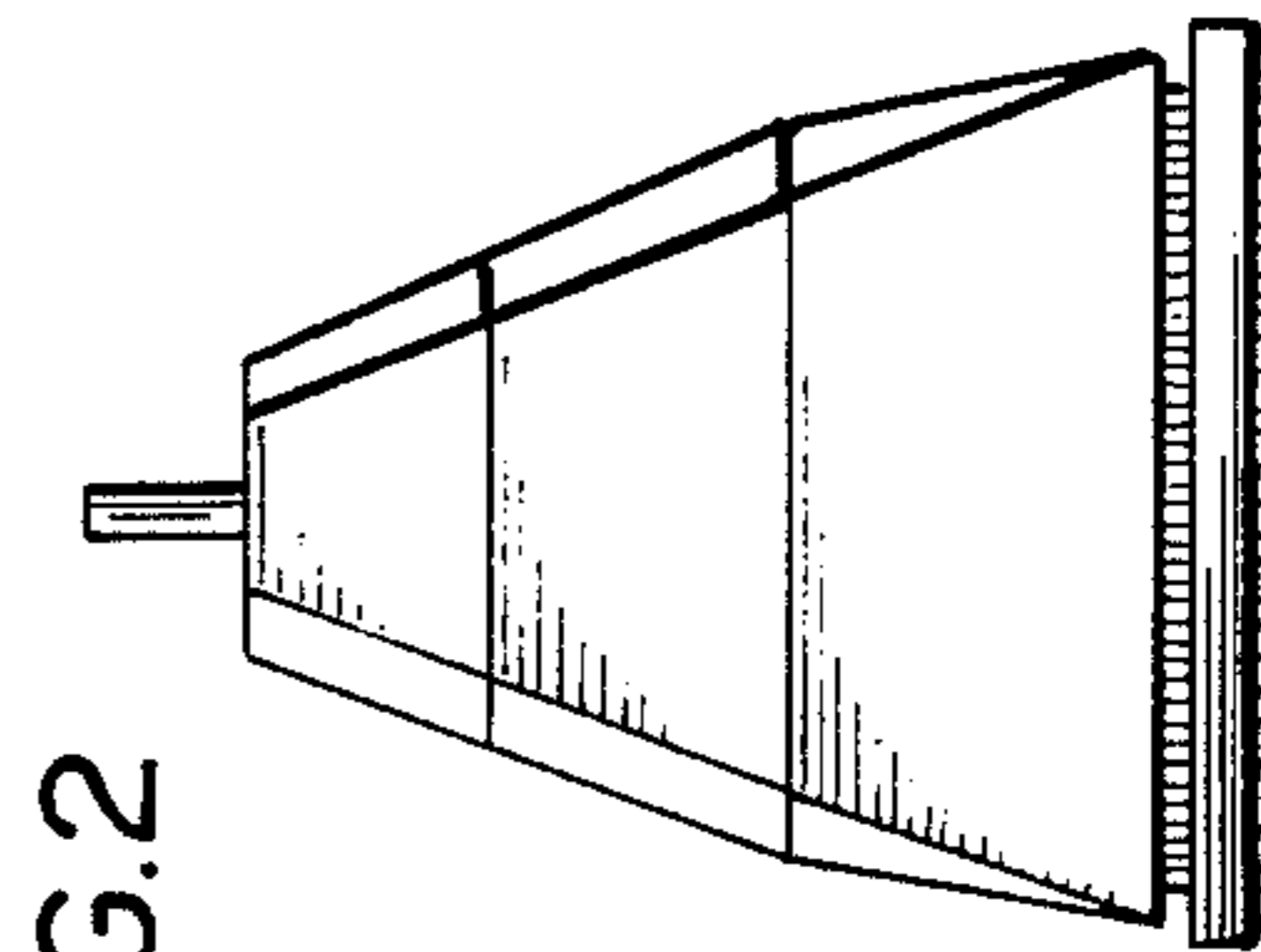
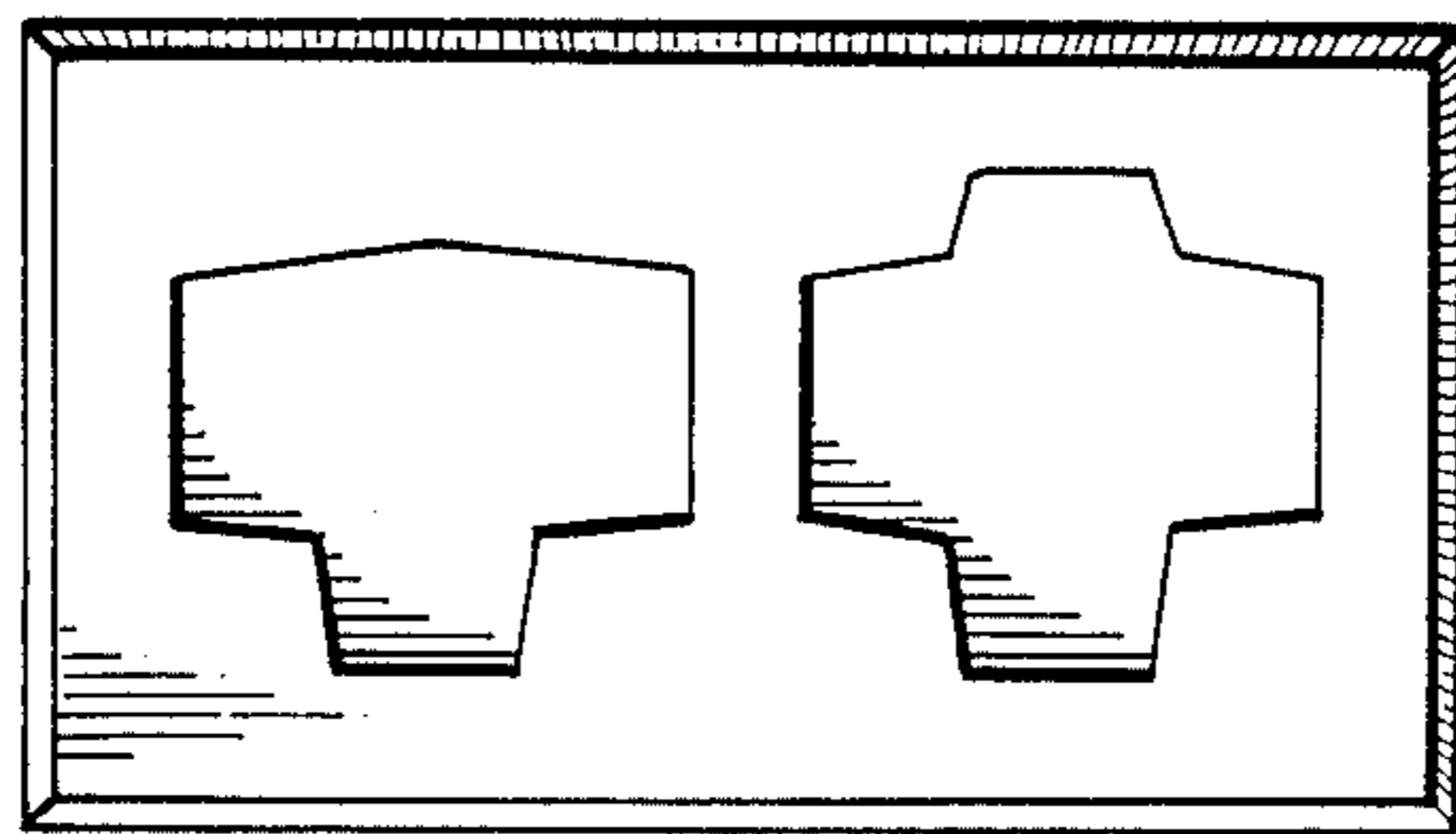
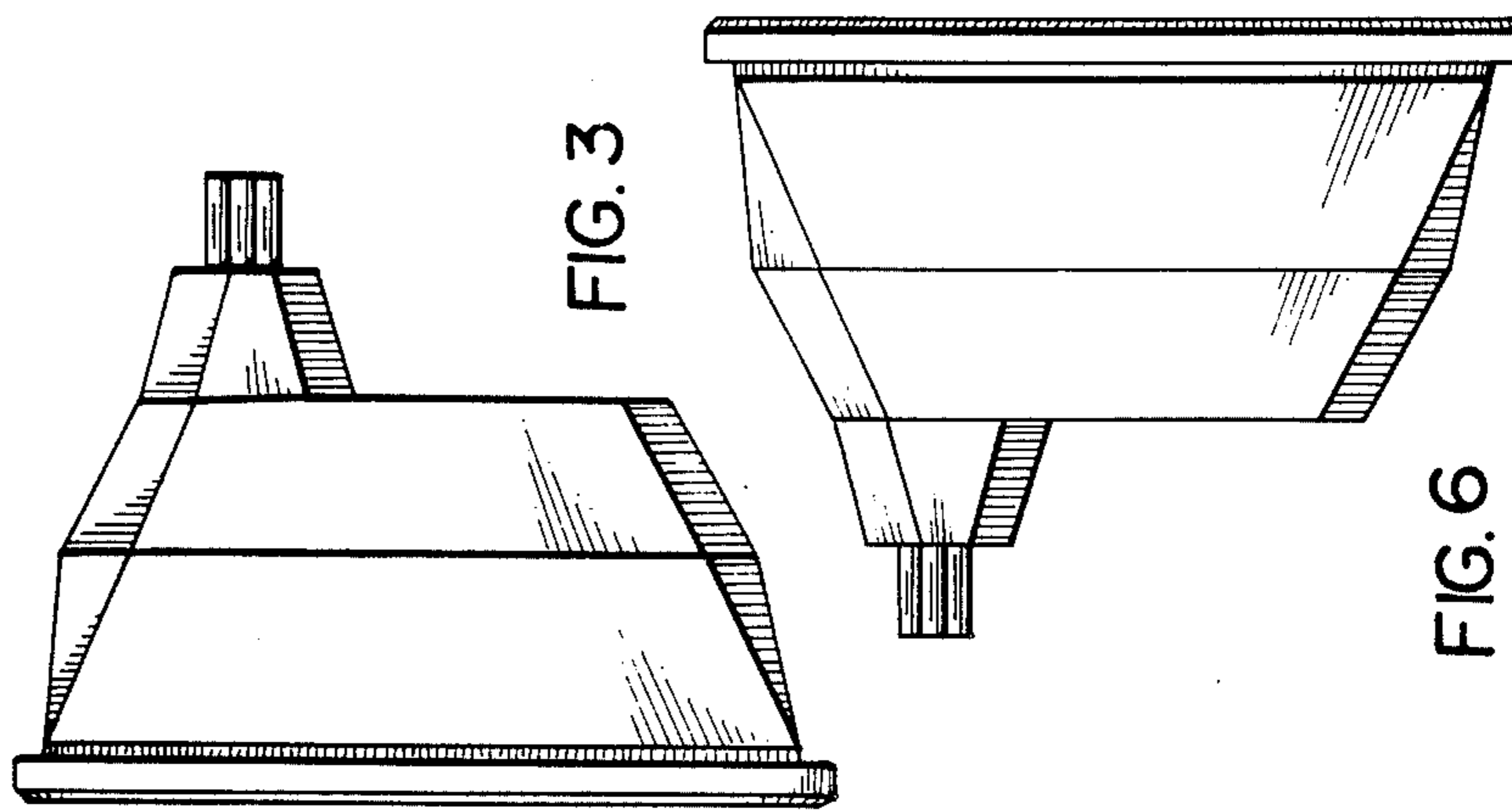

FIG. 3

FIG. 6

FIG. 2

FIG. 5

FIG. 1

FIG. 4