

United States Patent [19]

Aoki et al.

[11] Patent Number: Des. 307,850

[45] Date of Patent: ** May 15, 1990

[54] CAN HOLDER

[75] Inventors: Sanae Aoki; Tsunataka Konoike, both of Tokyo, Japan

[73] Assignee: Tanaka Manufacturing Company Limited, Tokyo, Japan

[**] Term: 14 Years

[21] Appl. No.: 88,103

[22] Filed: Aug. 21, 1987

[52] U.S. Cl. D7/624; D9/301

[58] Field of Search D7/70, 77; D9/455, 301; 220/85 H, 412; 62/371, 457.1-457.4, 457.8

[56] References Cited

U.S. PATENT DOCUMENTS

D. 229,034 11/1973 Miller D9/301
3,162,371 12/1964 Palmer et al. D9/301 X
4,462,444 7/1984 Larson 215/100.5

Primary Examiner—Bernard Ansher

Assistant Examiner—Terry A. Pfeffer
Attorney, Agent, or Firm—Amster, Rothstein & Ebenstein

[57] CLAIM

The ornamental design for a can holder, as shown and described.

DESCRIPTION

FIG. 1 is a top front isometric view of a can holder showing our new design;

FIG. 2 is a front elevational view thereof;

FIG. 3 is a side elevational view thereof, taken from one side;

FIG. 4 is a side elevational view thereof, taken from the one side, showing the can holder in a possible position of use;

FIG. 5 is a top plan view thereof; and

FIG. 6 is a bottom plan view thereof.

The view from the rear is identical to the view from the front; the view from the opposite side is identical to the view from the one side.

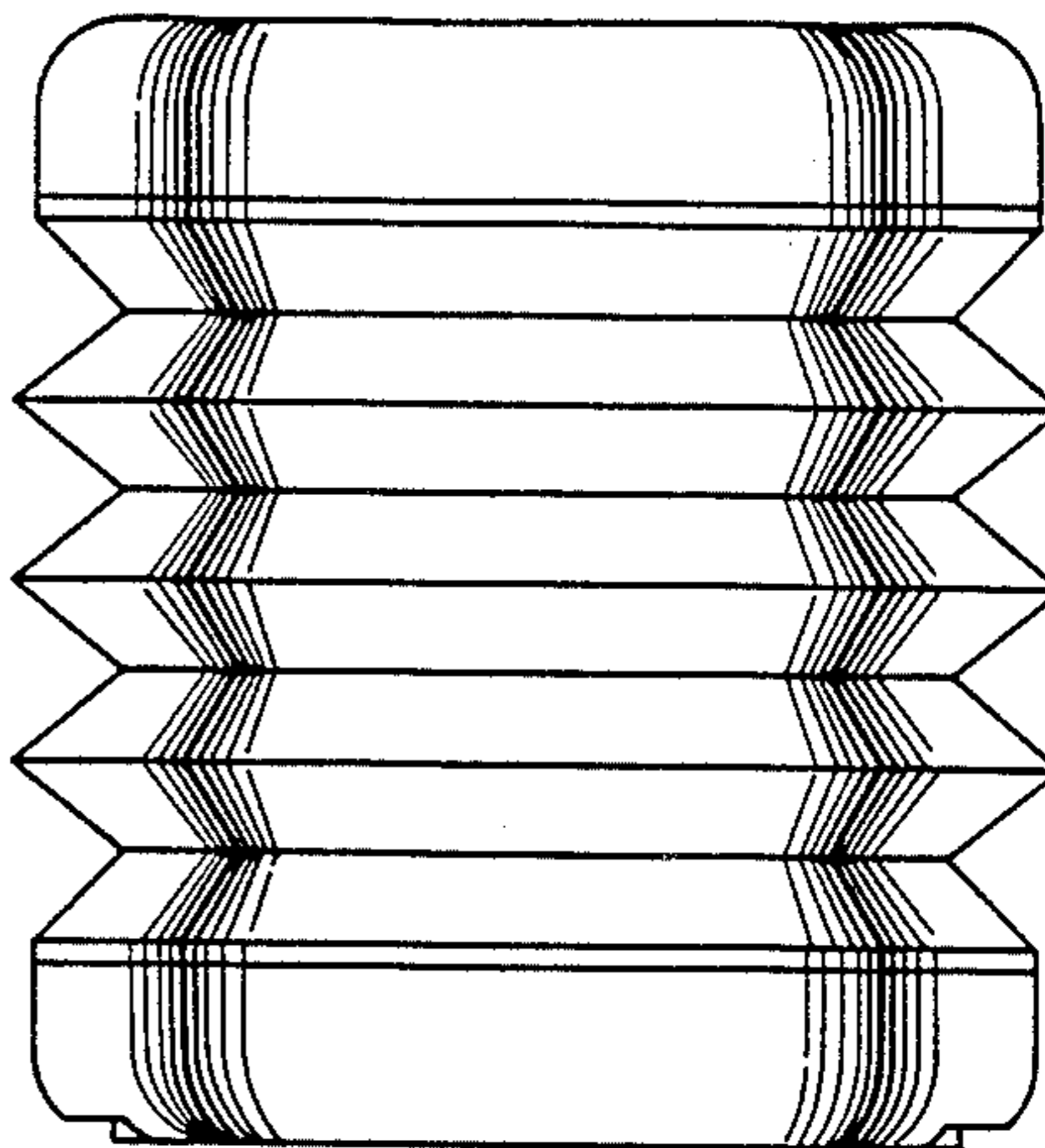
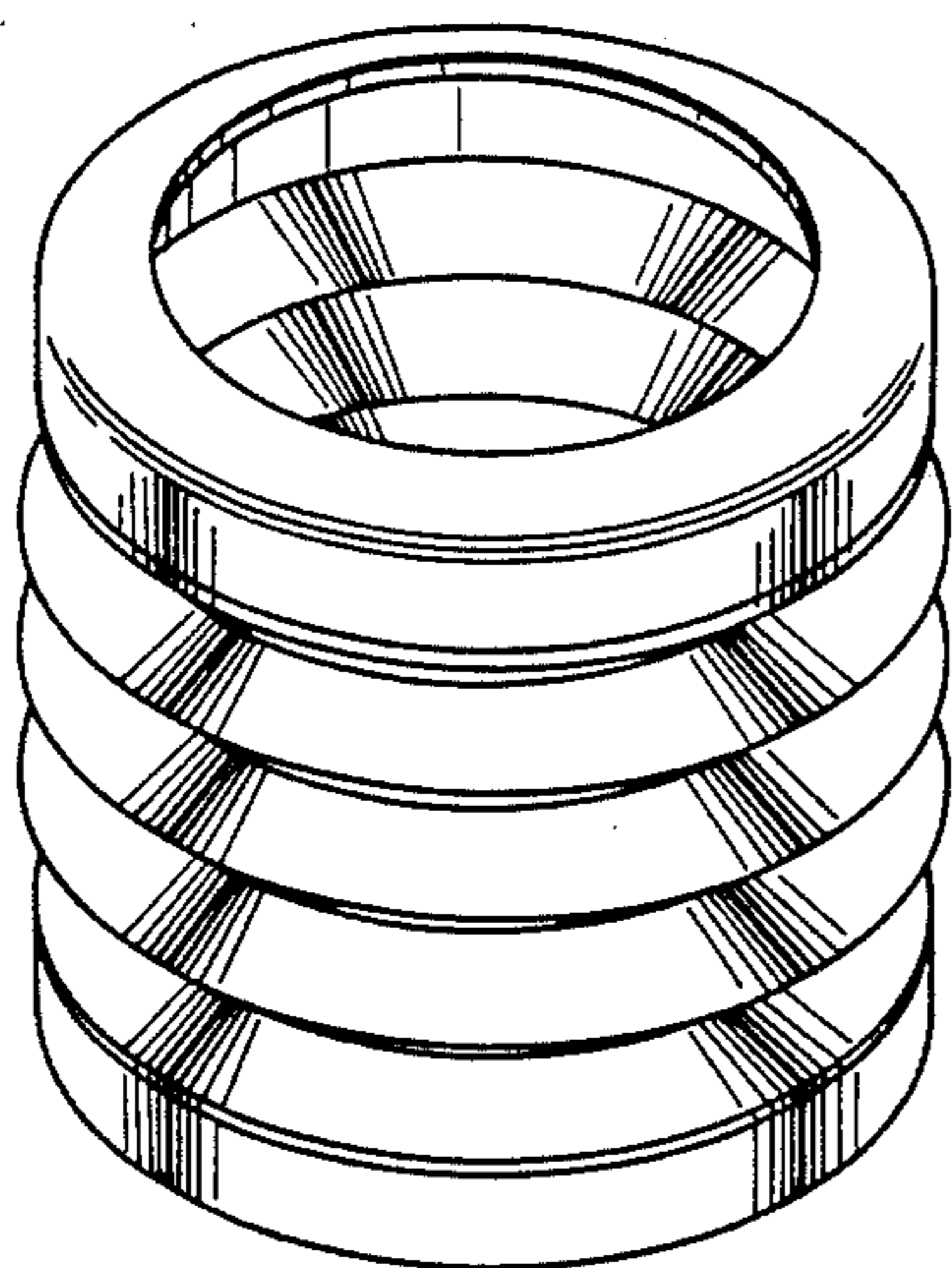

FIG. 1

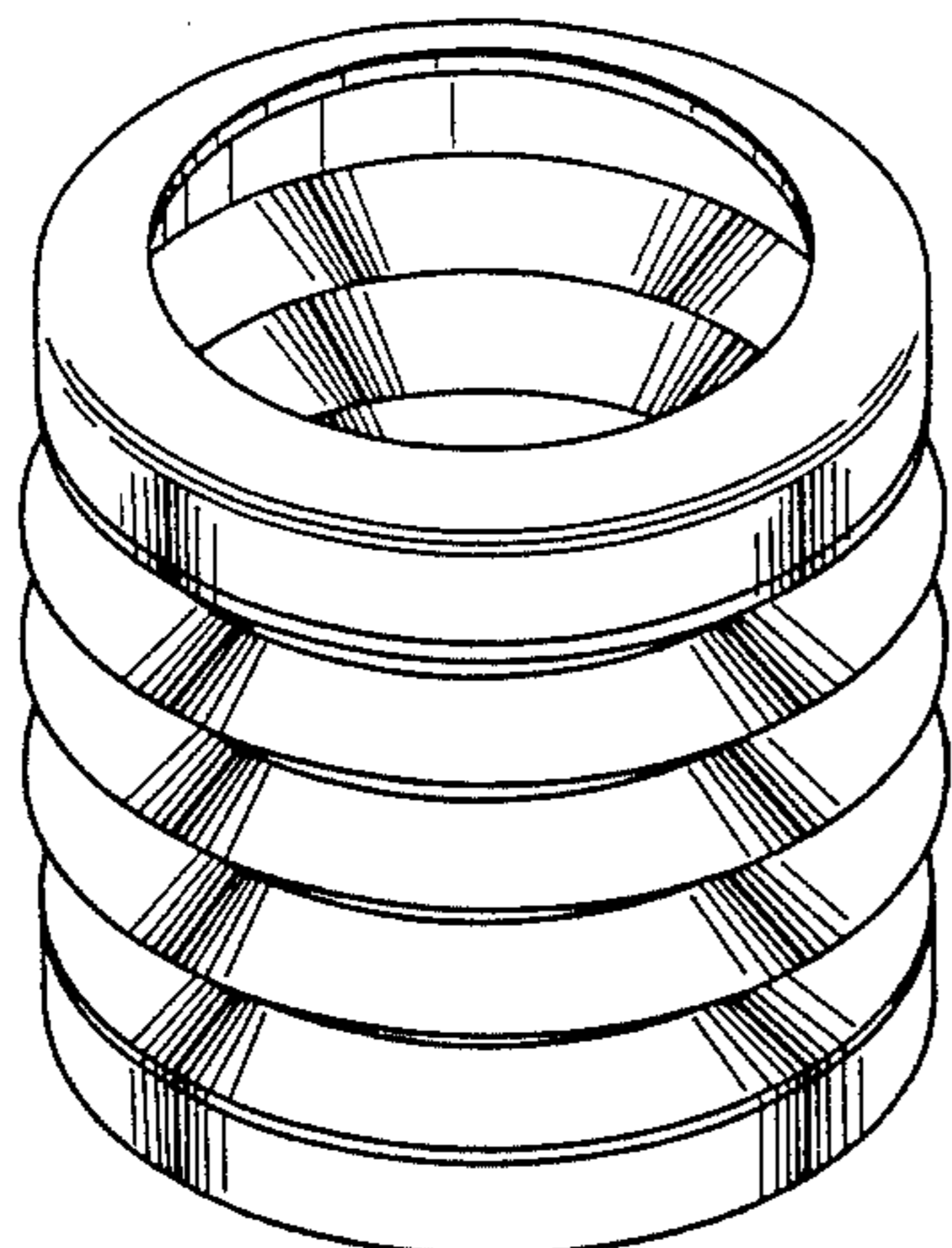

FIG. 2

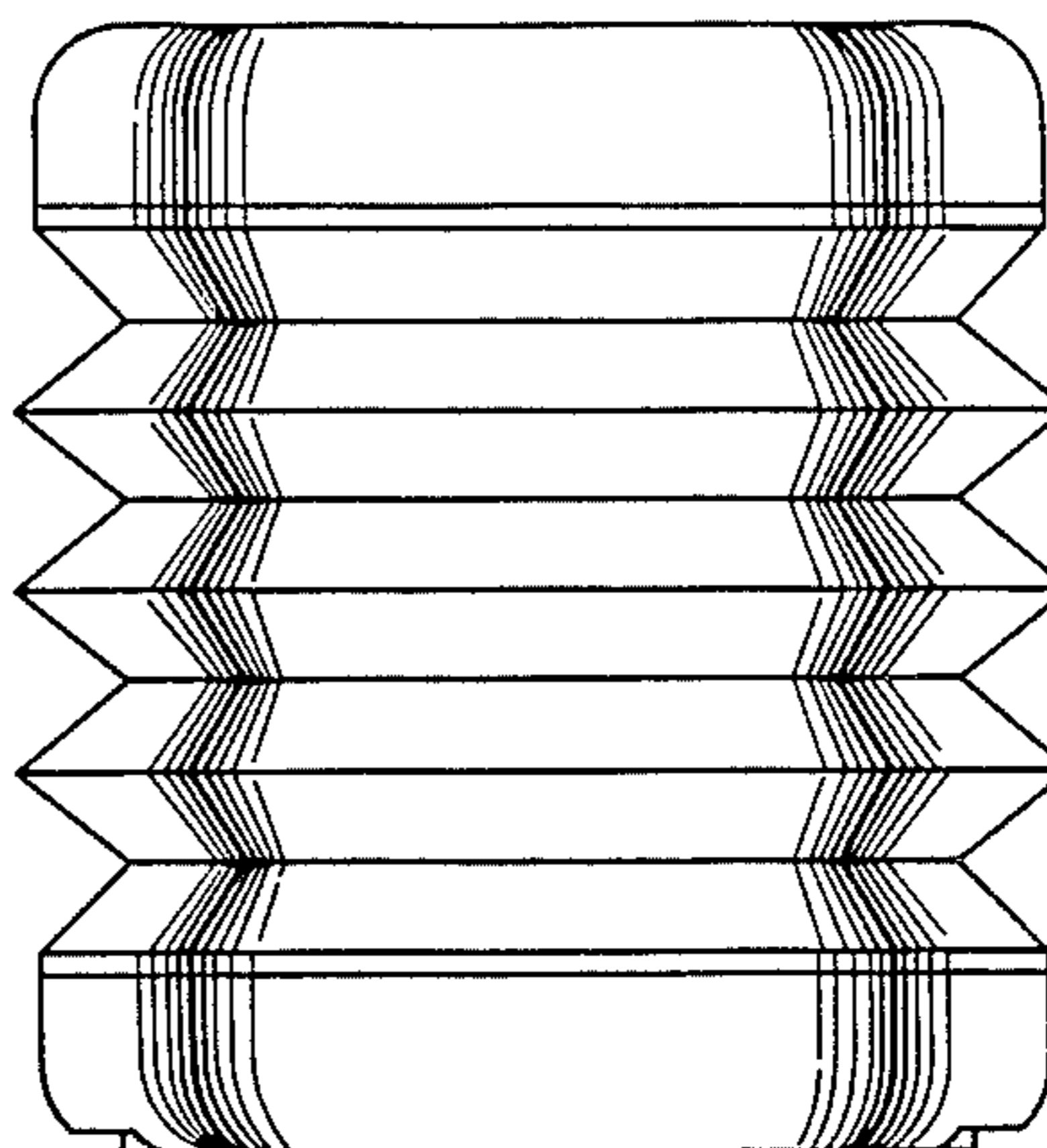

FIG. 4

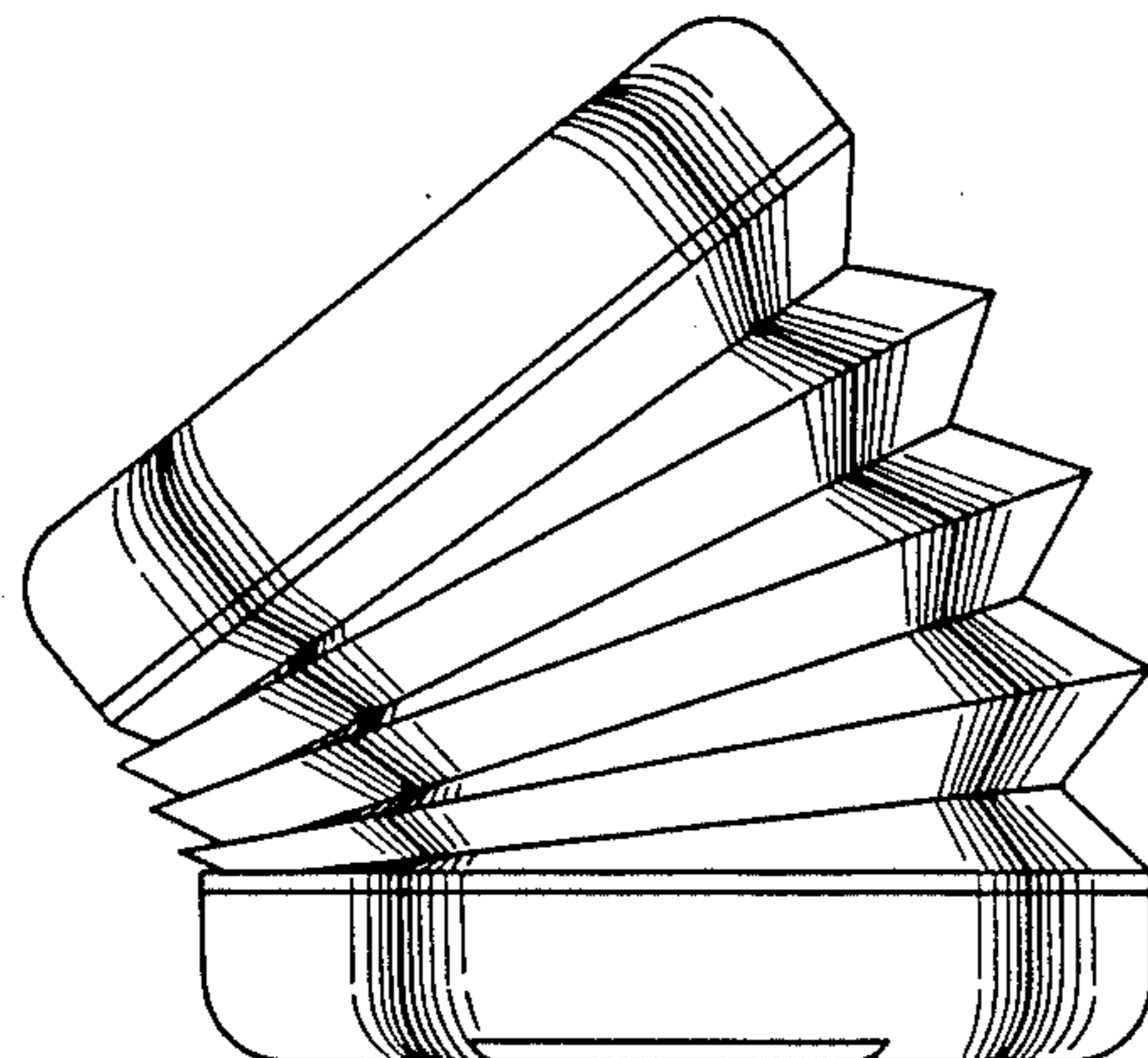

FIG. 3

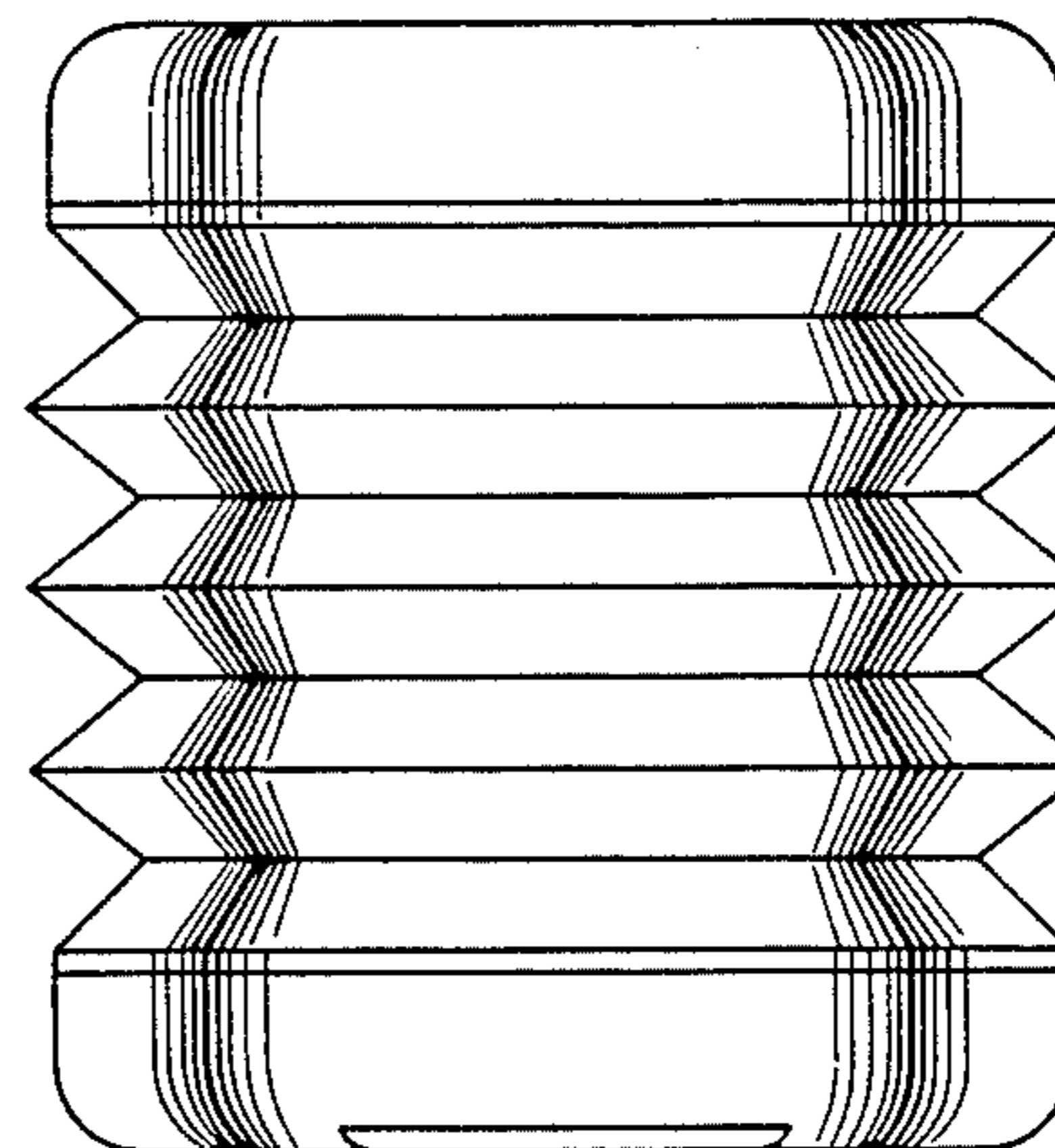

FIG. 5

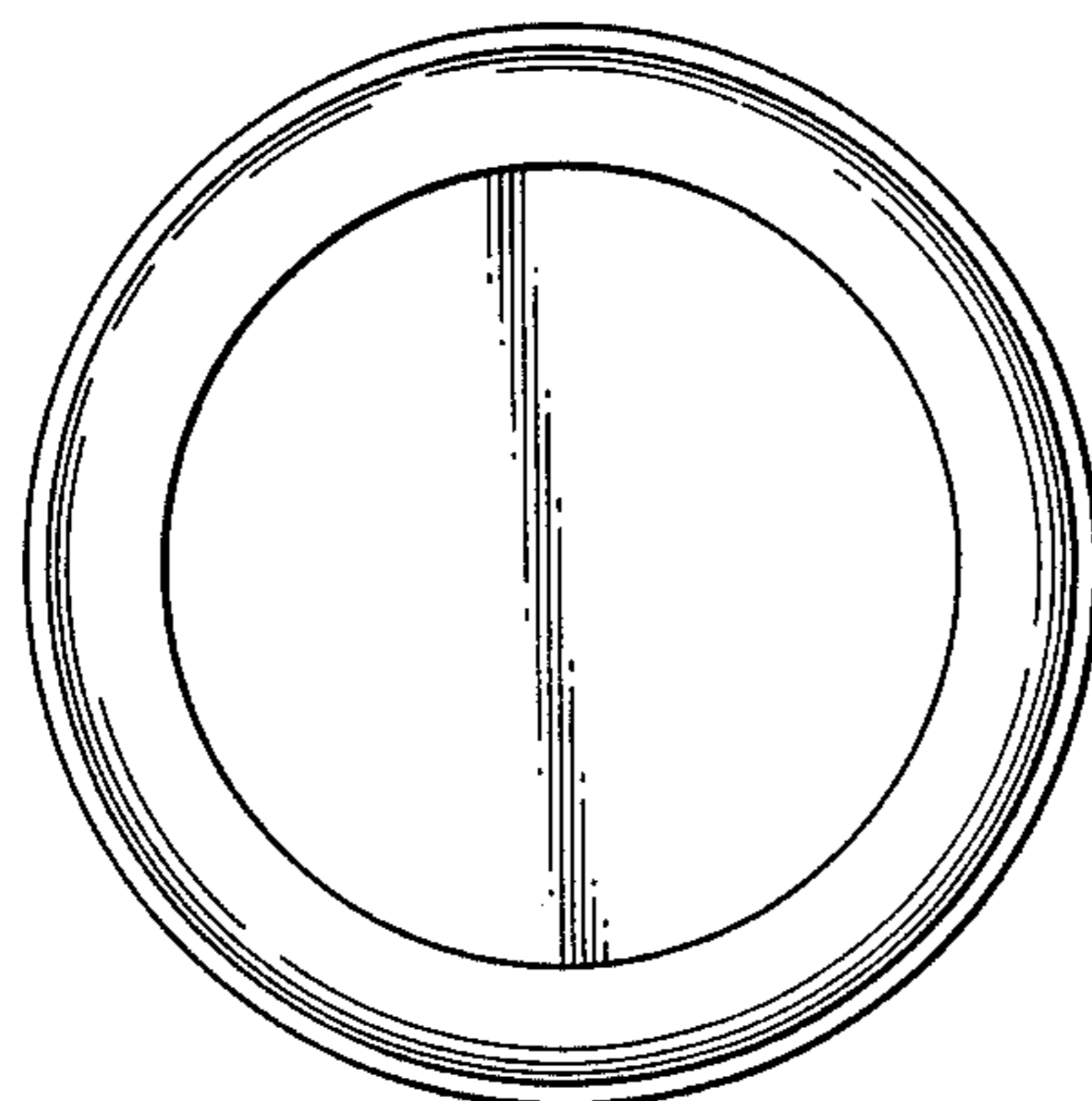

FIG. 6

