

United States Patent [19]

Sudoh et al.

[11] Patent Number: **Des. 307,834**

[45] Date of Patent: **** May 15, 1990**

[54] **CHILD CAR SEAT**

[75] Inventors: **Kunio Sudoh, Tokyo; Kohei Nogami, Narashino, both of Japan**

[73] Assignee: **Nippon Seiko K.K., Tokyo, Japan**

[**] Term: **14 Years**

[21] Appl. No.: **943,919**

[22] Filed: **Dec. 18, 1986**

[52] U.S. Cl. **D6/333**

[58] Field of Search **D6/333, 334**

[56] **References Cited**

U.S. PATENT DOCUMENTS

- D. 231,589 5/1974 Bloom D6/333
- D. 288,036 2/1987 Johnson, Jr. D6/333

D. 291,032 7/1987 Sauter et al. D6/333

Primary Examiner—Bruce W. Dunkins
Assistant Examiner—Ann Hunt
Attorney, Agent, or Firm—Bachman & LaPointe

[57] **CLAIM**

The ornamental design for a child car seat, as shown and described.

DESCRIPTION

FIG. 1 is a perspective view of a child car seat showing our new design;
FIG. 2 is a front elevational view thereof;
FIG. 3 is a rear elevational view thereof;
FIG. 4 is a top plan view thereof;
FIG. 5 is a bottom plan view thereof;
FIG. 6 is a right side elevational view thereof; and
FIG. 7 is a left side elevational view thereof.

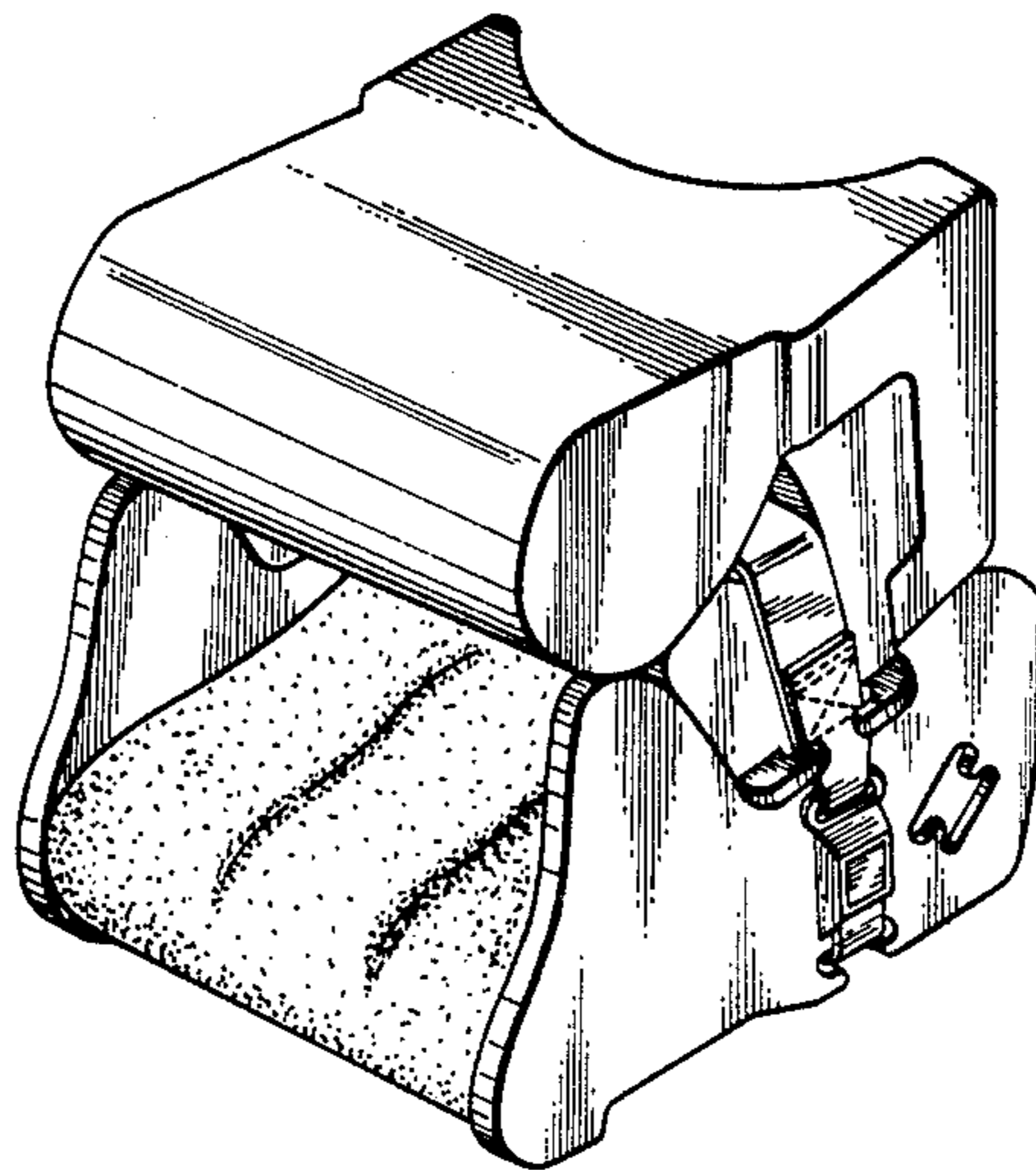

FIG. 1

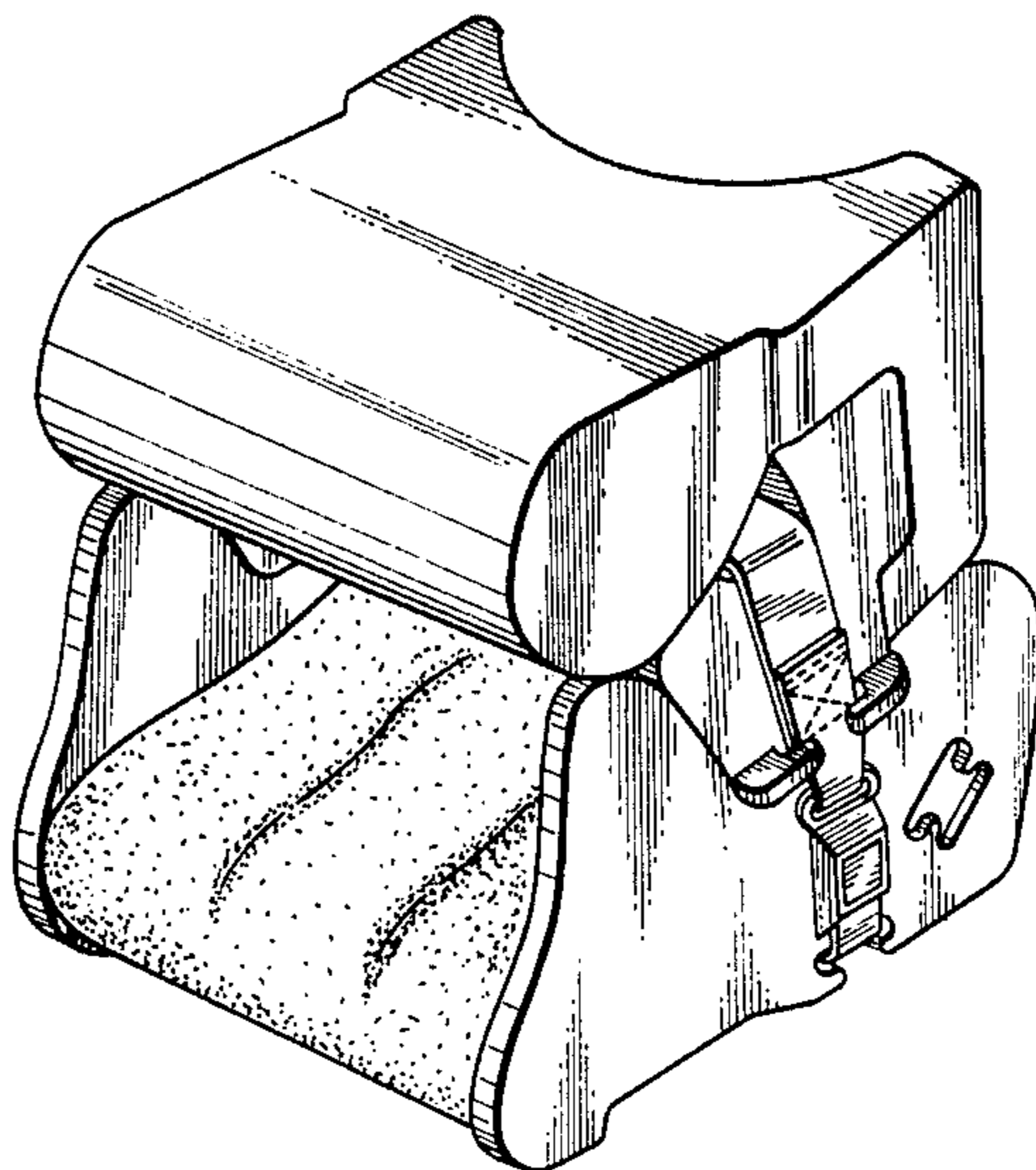

FIG. 2

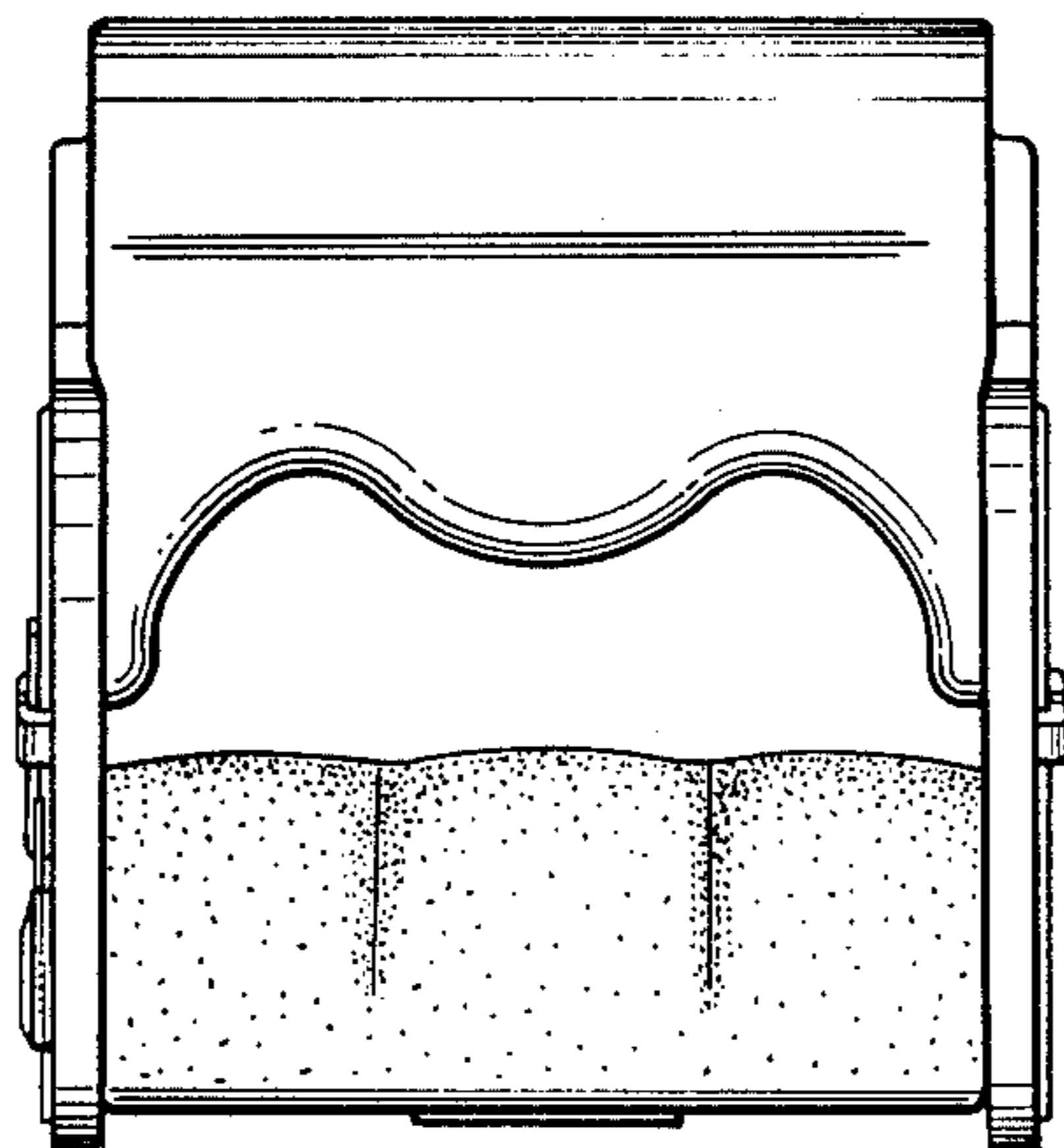

FIG. 3

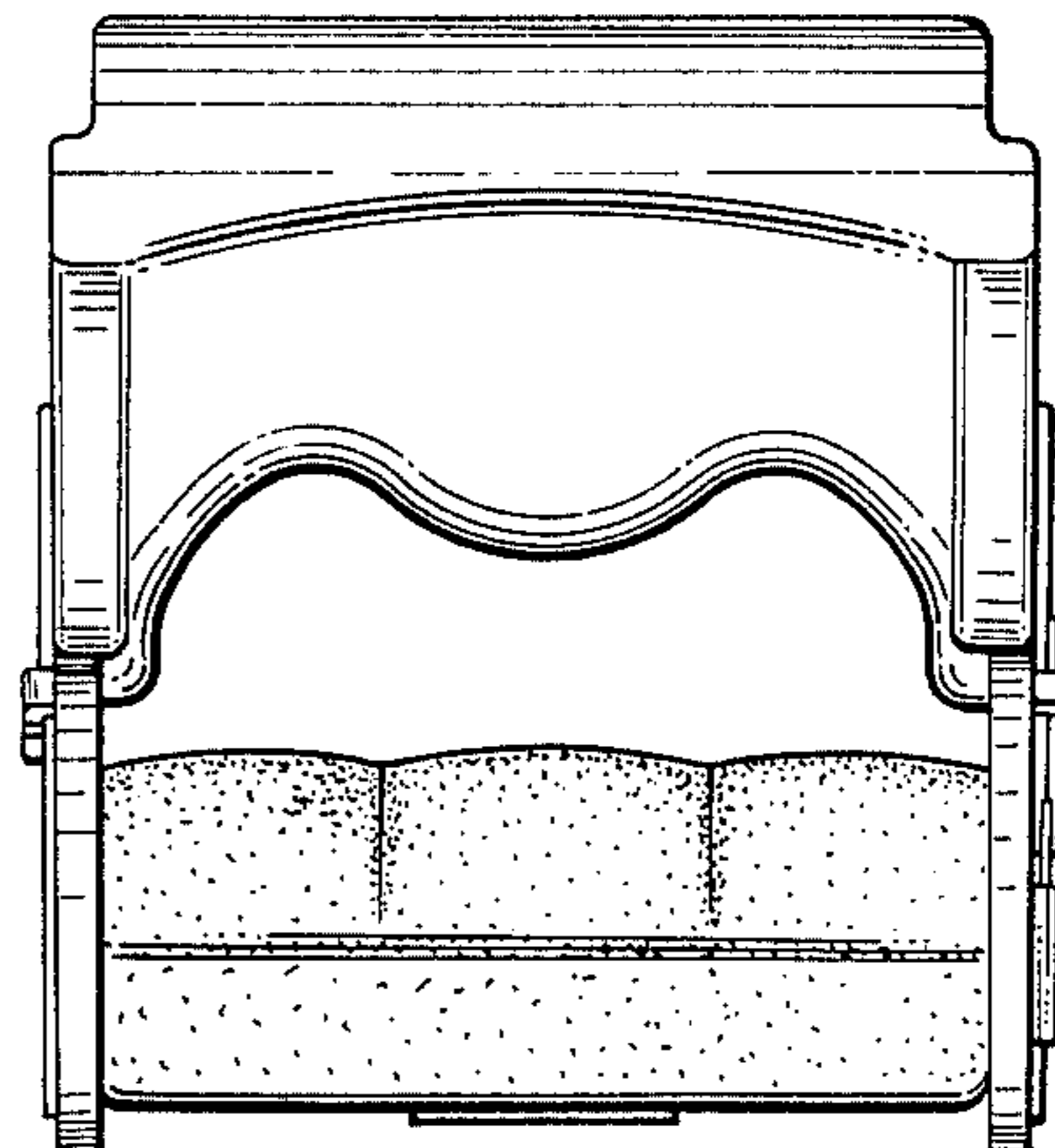

FIG. 4

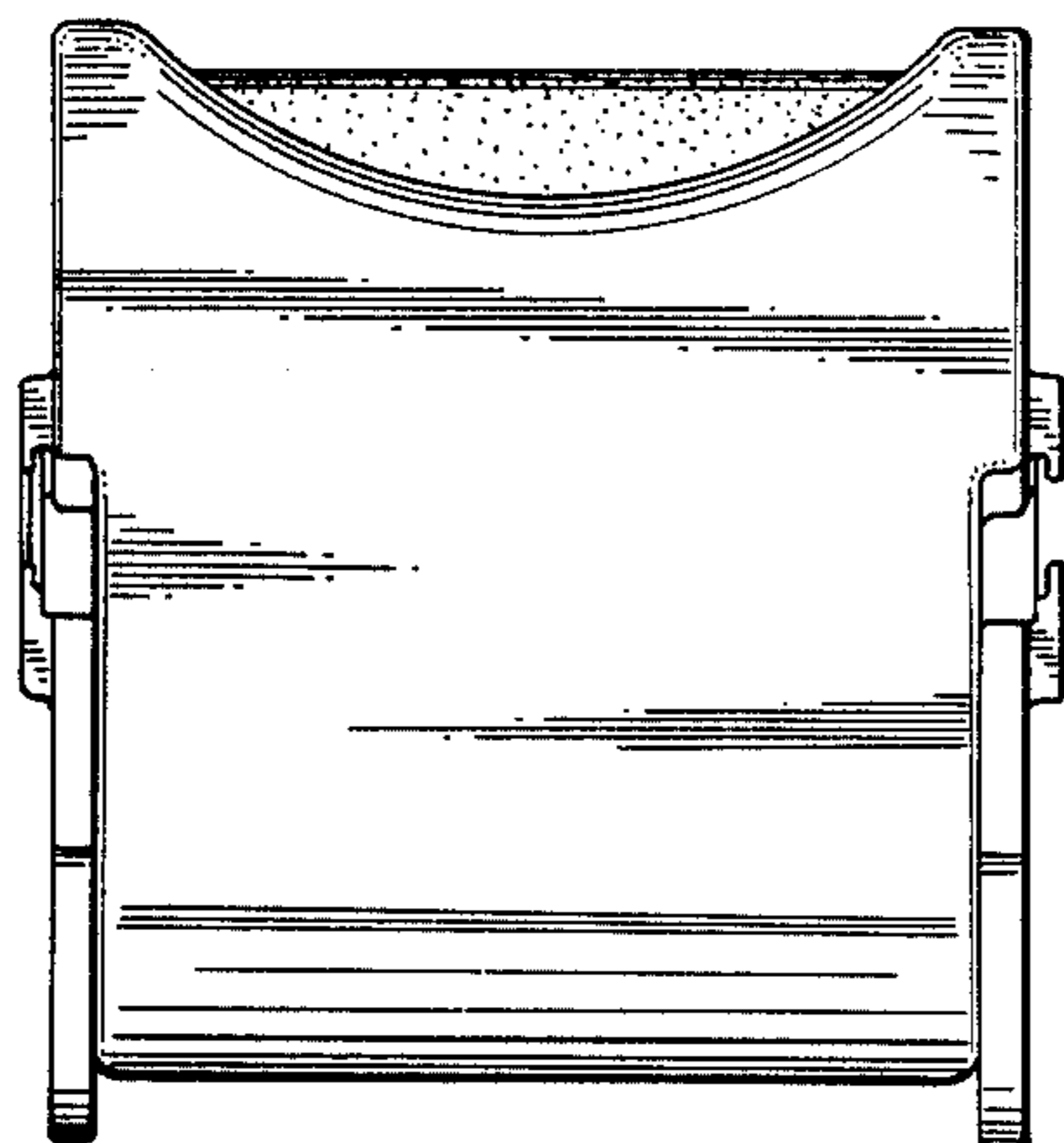

FIG. 5

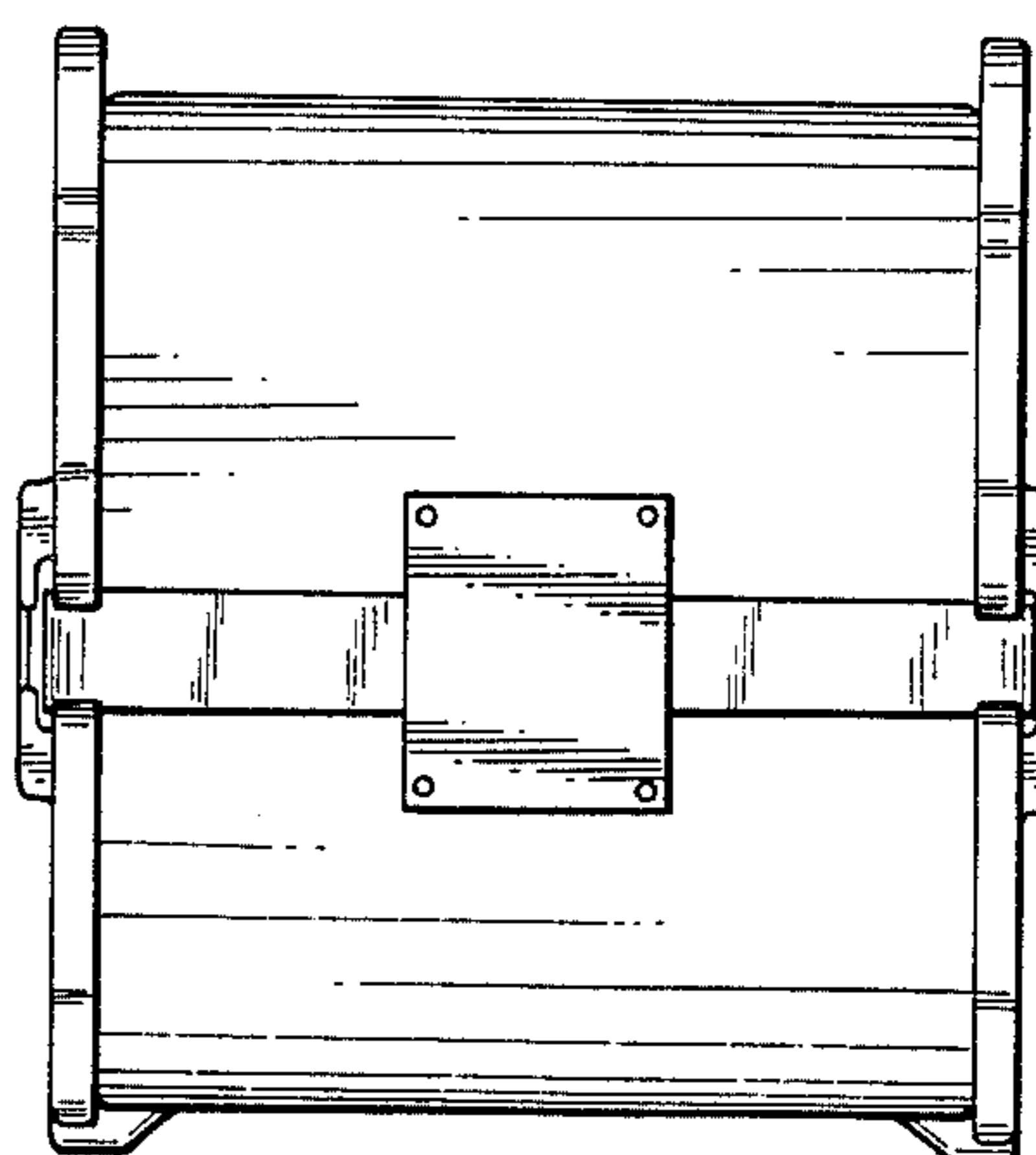

FIG. 7

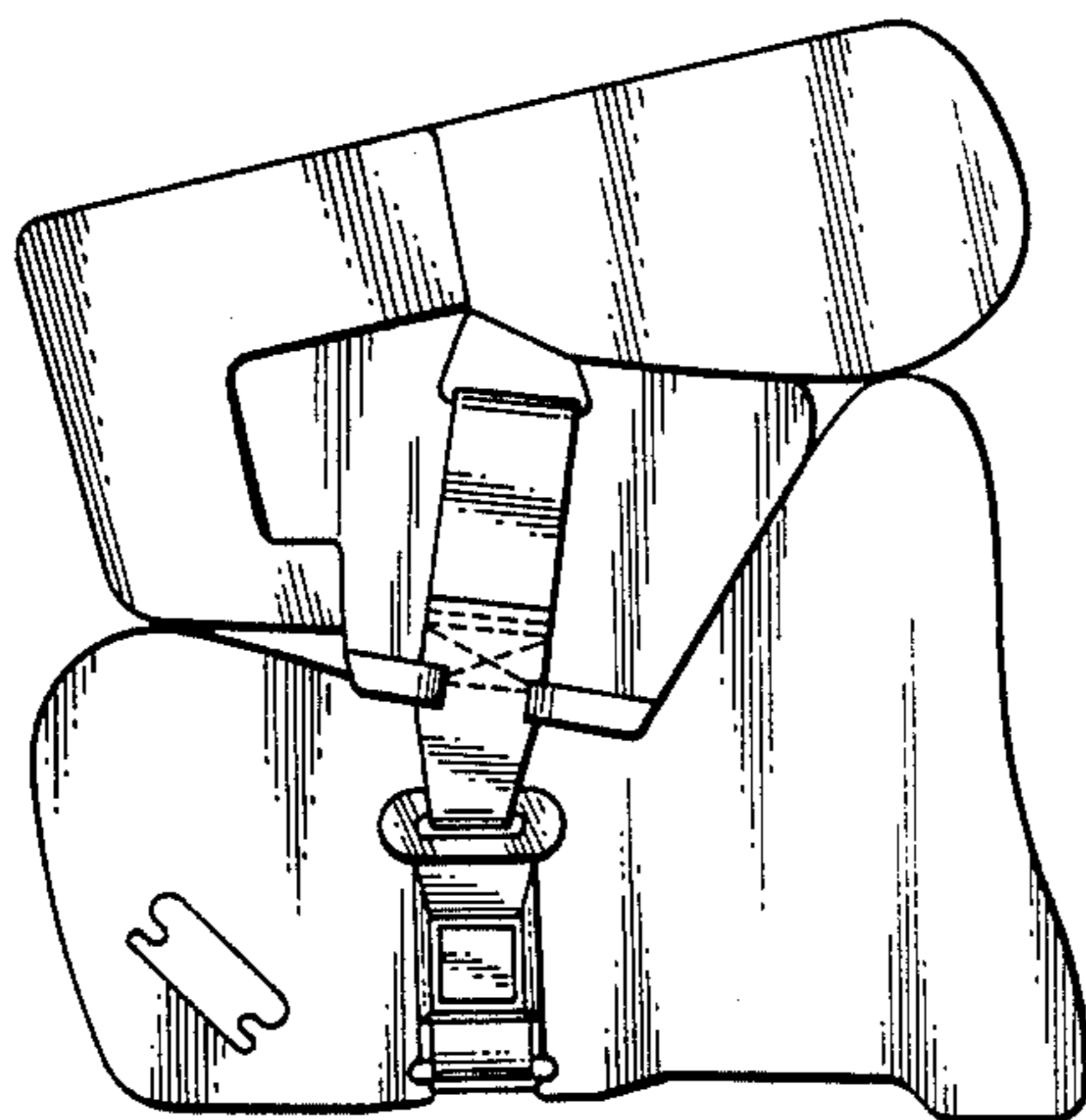

FIG. 6

