

[54] COMBINED CONTAINER/BOTTLE AND COSMETIC WAND APPLICATORS OR THE LIKE

[75] Inventors: Henry J. Cassai, 163-47 85th St., Howard Beach, N.Y. 11414; Gino H. Cassai, Brooklyn, N.Y.

[73] Assignee: Henry J. Cassai, Howard Beach, N.Y.

[**] Term: 14 Years

[21] Appl. No.: 321,555

[22] Filed: Mar. 10, 1989

Related U.S. Application Data

[62] Division of Ser. No. 790,517, Oct. 23, 1985, Pat. No. Des. 300,269.

[52] U.S. Cl. D28/77; D9/372

[58] Field of Search D28/4-8, D28/61, 73, 76-91.1; D3/39; D9/337, 338, 341, 347, 367, 377, 372; 220/DIG. 26; 206/235, 385, 581, 823; 132/286, 288, 293, 294, 297-301, 303-305, 313-318

[56] References Cited

U.S. PATENT DOCUMENTS

- D. 70,623 7/1926 Morrison D9/372
D. 183,674 10/1958 Bau D28/7 X
D. 276,698 12/1984 Carlson D9/372

FOREIGN PATENT DOCUMENTS

2037409 2/1972 Fed. Rep. of Germany ... D28/7 X

Primary Examiner—Louis S. Zarfes

[57] CLAIM

The ornamental design for combined container/bottle and cosmetic wand applicators or the like, as shown and described.

DESCRIPTION

FIG. 1 is an exploded front elevational view of a "combined container/bottle and cosmetic wand applicators or the like" showing our new design;

FIG. 2 is a rear elevational view thereof with applicator caps on;

FIG. 3 is a partially exploded side elevational view showing a second embodiment of our new design wherein the applicator caps have been modified;

FIG. 4 is a top plan view of FIG. 1;

FIG. 5 is a bottom plan view thereof;

FIG. 6 is a front elevational view of a "combined container/bottle and cosmetic wand applicators or the like" with applicator caps on, showing a third embodiment of our new design;

FIG. 7 is a rear elevational view thereof;

FIG. 8 is a side elevational view of FIG. 6 showing a fourth embodiment of our new design wherein the applicator caps have been modified;

FIG. 9 is a top plan view of FIG. 6 with applicator caps removed;

FIG. 10 is a bottom plan view thereof, with applicator caps removed;

FIG. 11 is a front elevational view of a "combined container/bottle and cosmetic wand applicators or the like" with applicator caps on, showing a fifth embodiment of our new design;

FIG. 12 is a rear elevational view thereof;

FIG. 13 is a side elevational view of FIG. 11 showing a sixth embodiment of our new design wherein the applicator caps have been modified;

FIG. 14 is a top plan view of FIG. 11, with applicator caps removed;

FIG. 15 is a bottom plan view thereof, with applicator caps removed;

FIG. 16 is a front elevational view of a "combined container/bottle and cosmetic wand applicators or the like" with applicator caps on, showing a seventh embodiment of our new design;

FIG. 17 is a rear elevational view thereof;

FIG. 18 is a side elevational view of FIG. 16 showing an eighth embodiment of our new design wherein the applicator caps have been modified;

FIG. 19 is a top plan view of FIG. 16, with applicator caps removed;

FIG. 20 is a bottom plan view thereof, with applicator caps removed;

FIG. 21 is a front elevational view of a "combined container/bottle and cosmetic wand applicators or the

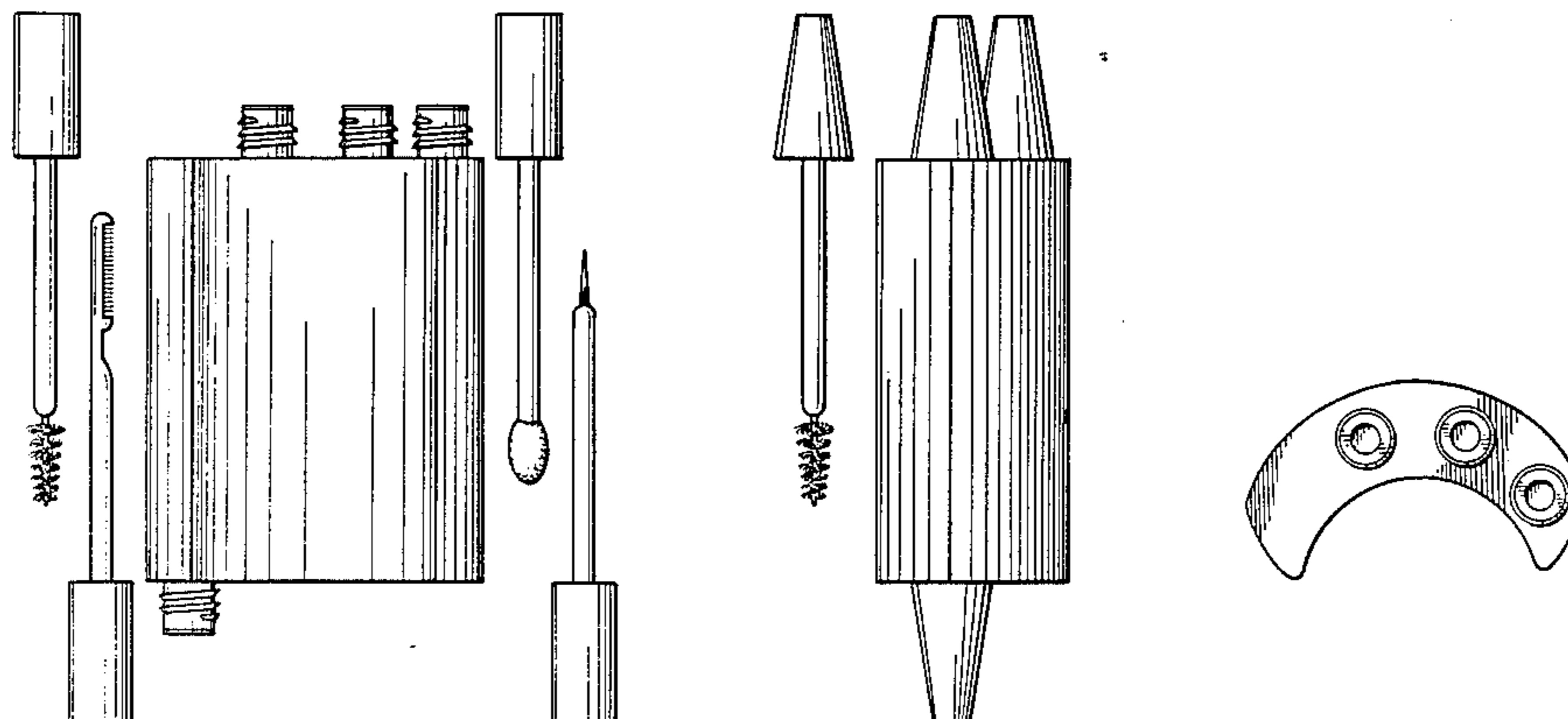

Des. 307,809

Page 2

like" with applicator caps on, showing a ninth embodiment of our new design;

FIG. 22 is a rear elevational view thereof;

FIG. 23 is a side elevational view of FIG. 21 showing a

tenth embodiment of our new design wherein the applicator caps have been modified;

FIG. 24 is a top plan view of FIG. 21, with applicator caps removed; and

FIG. 25 is a bottom plan view thereof, with applicator cap removed.

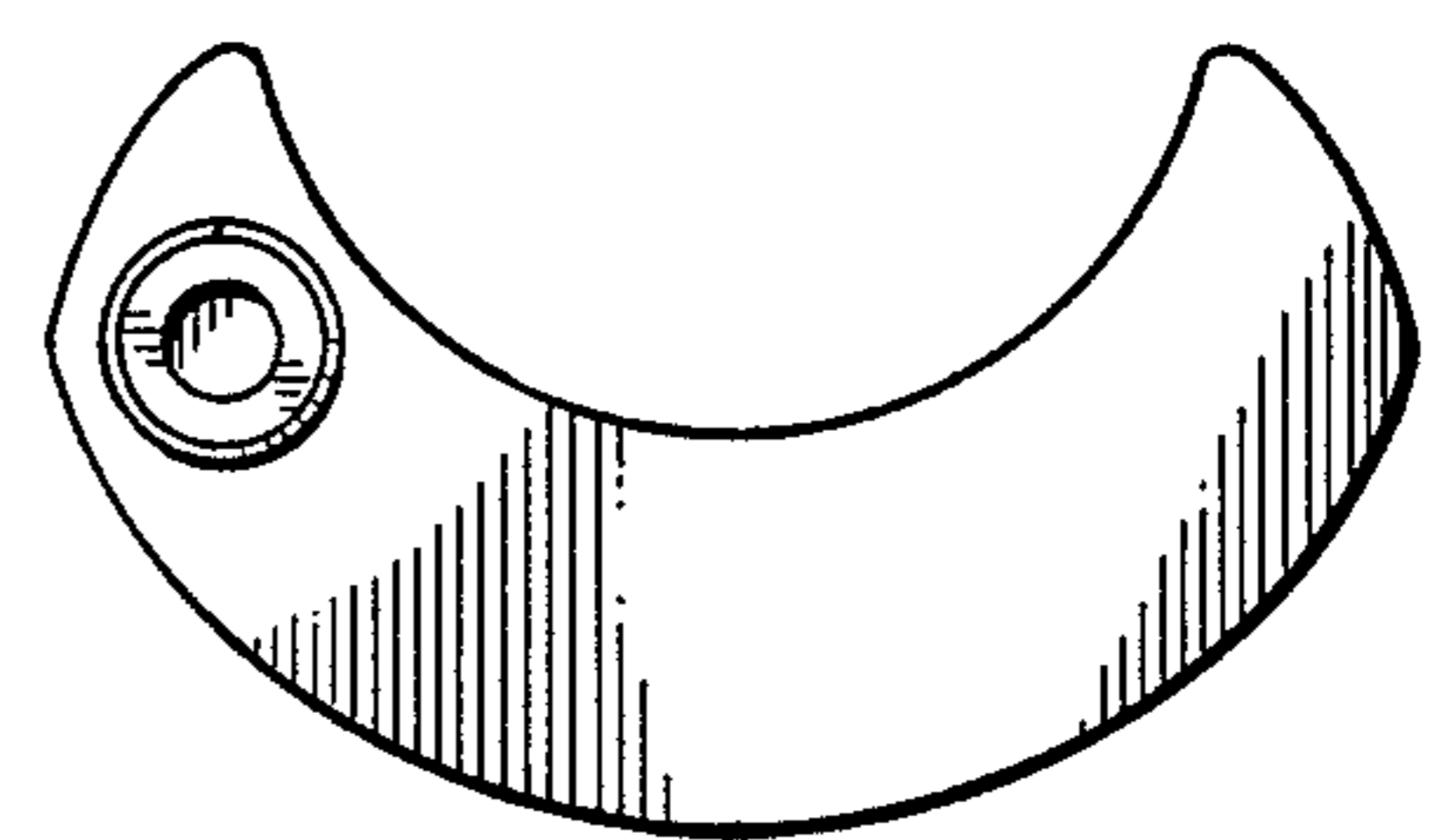
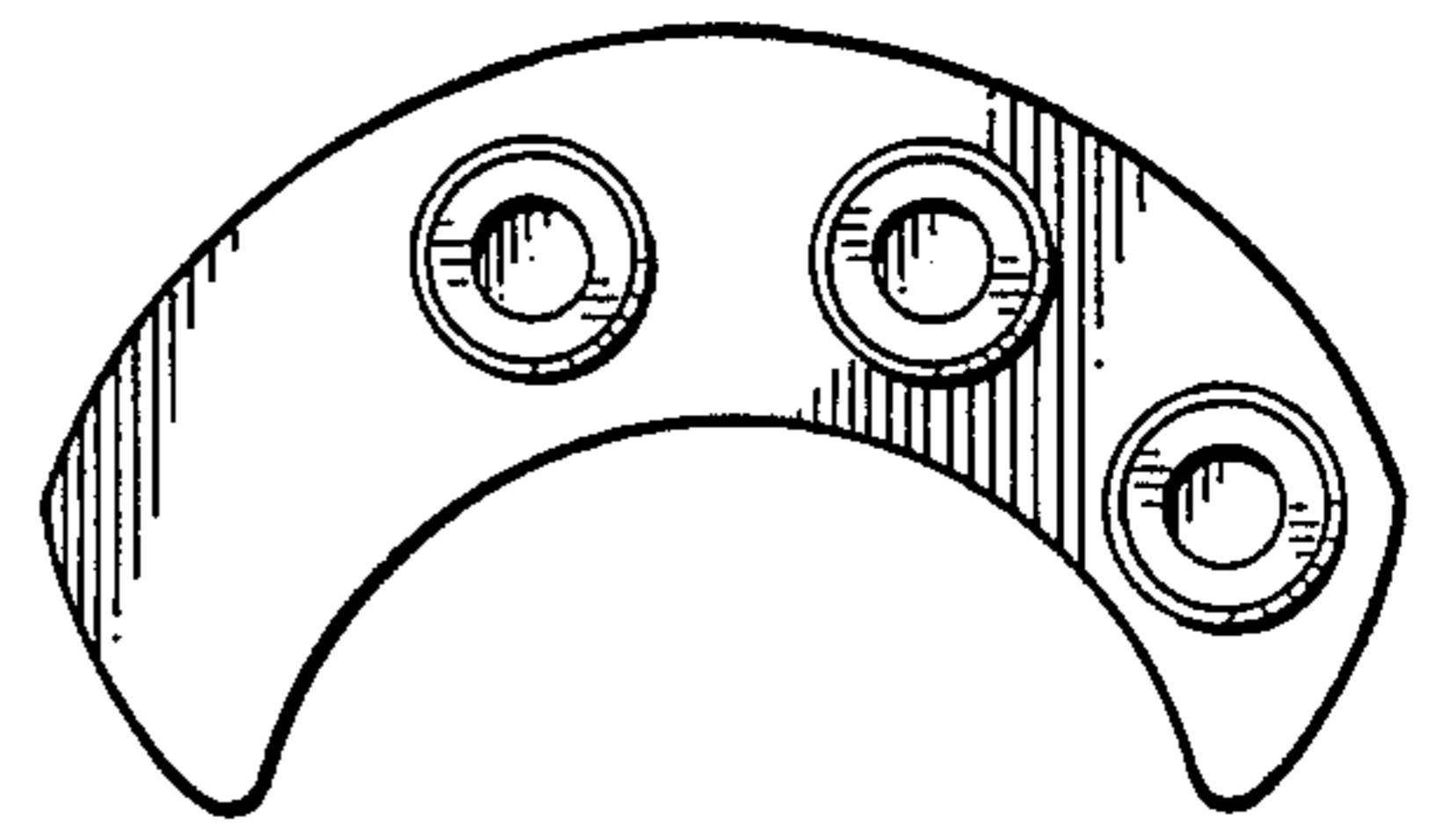
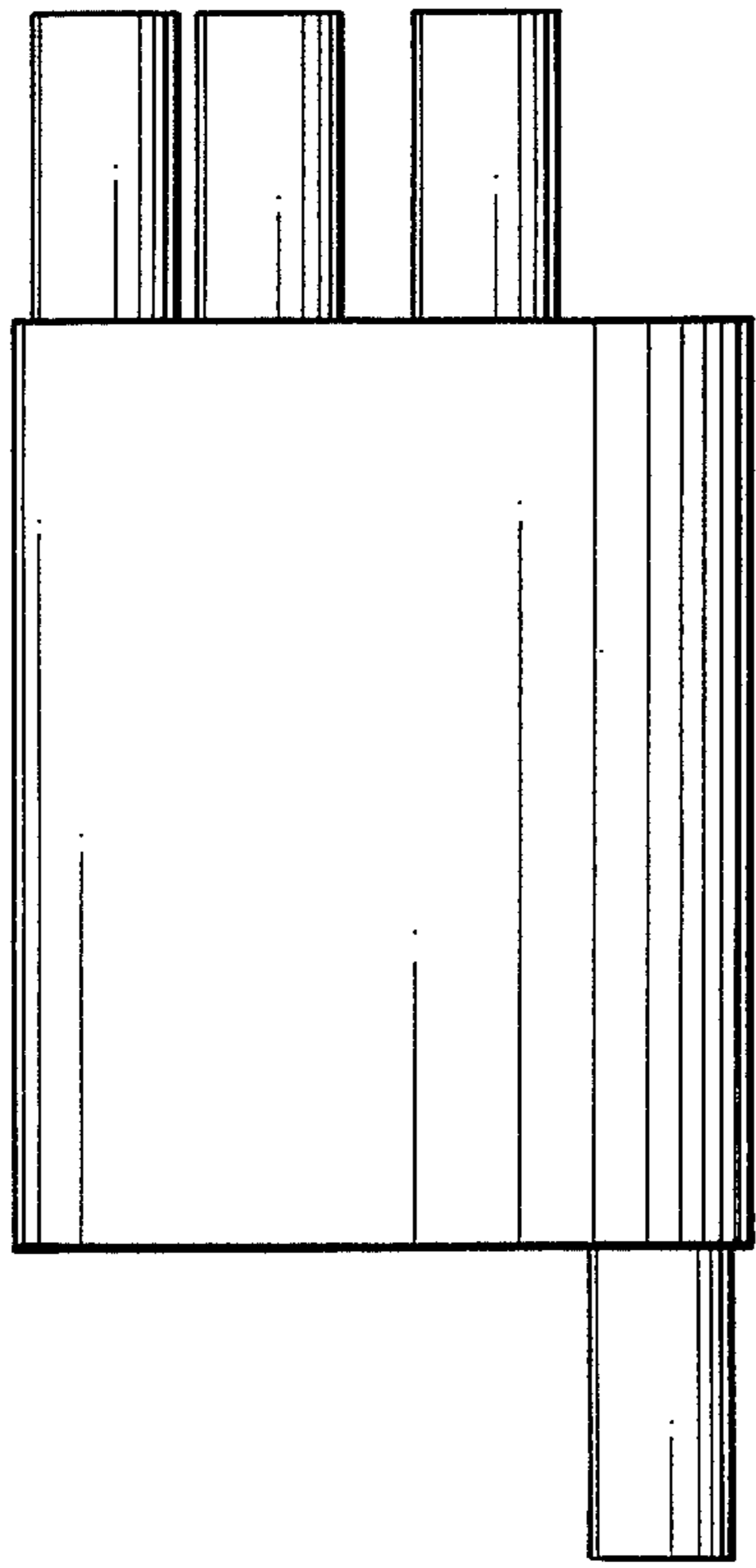
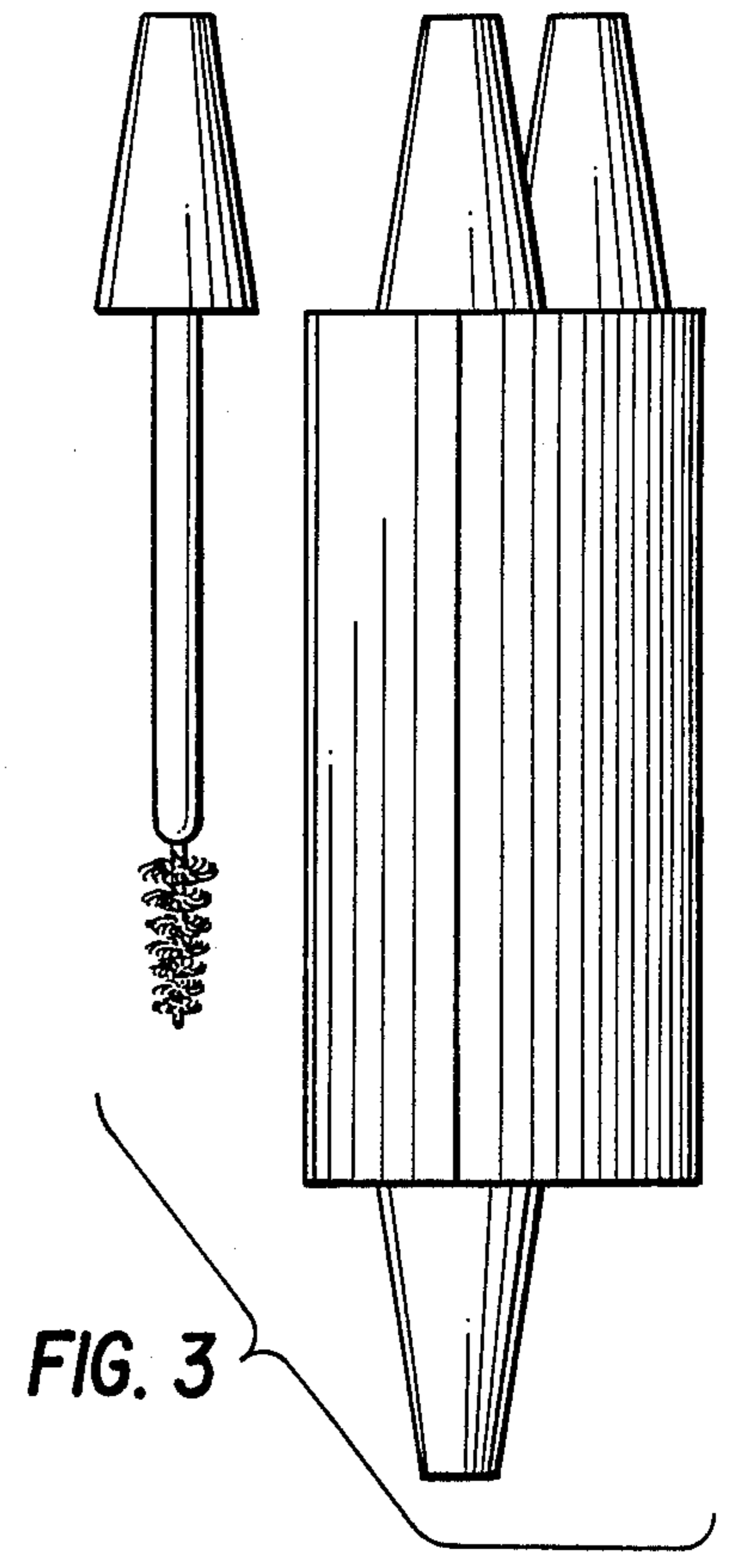
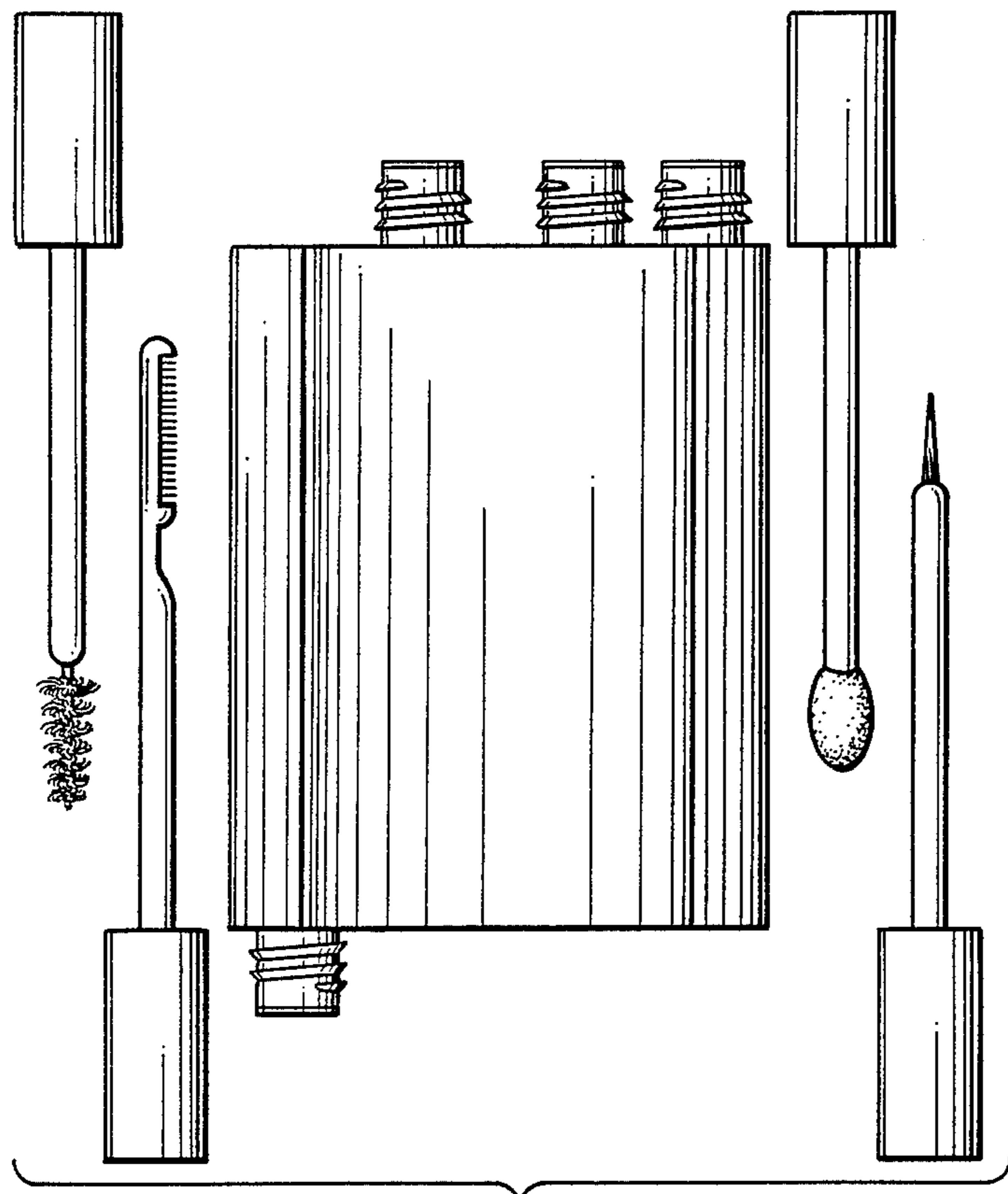

FIG. 2

FIG. 5

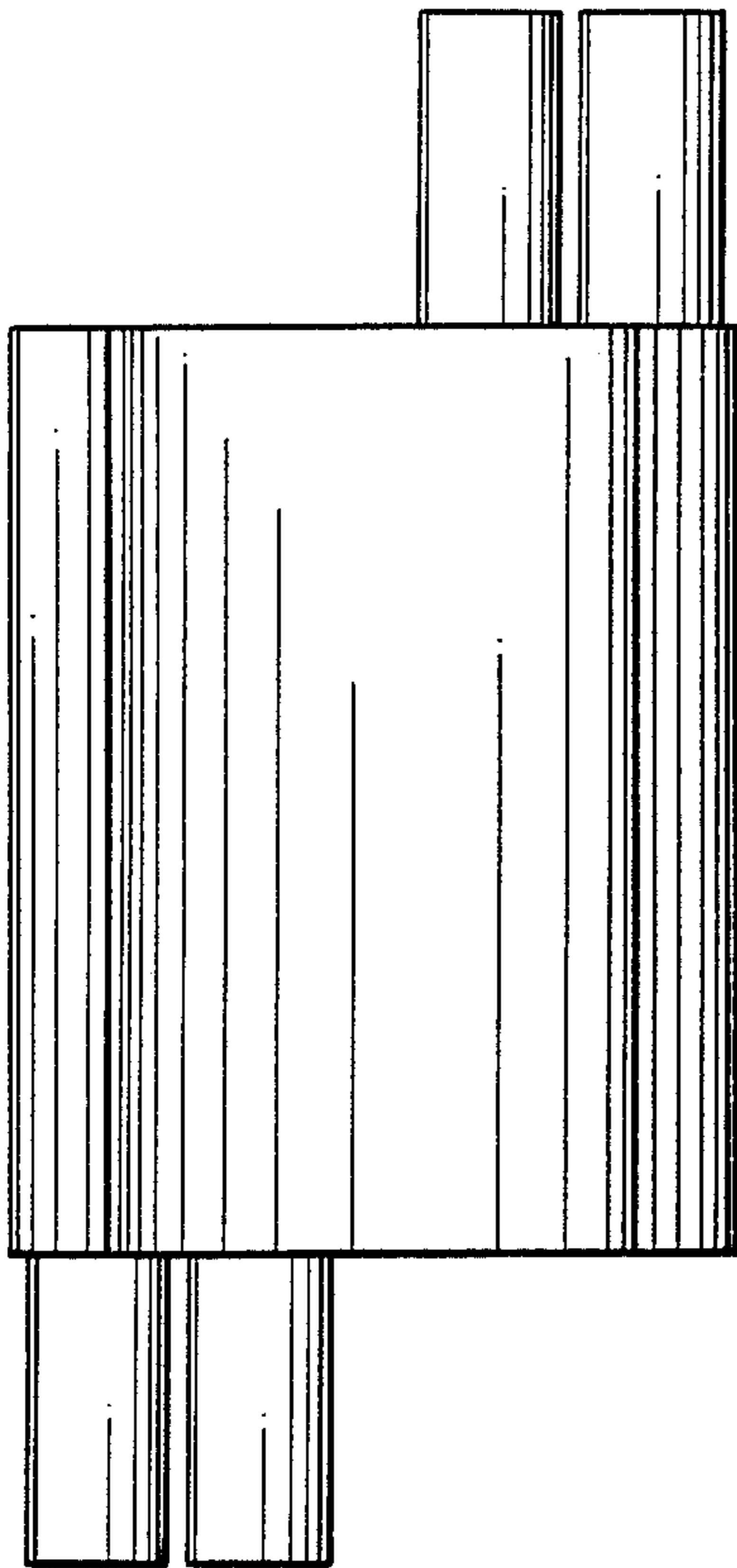

FIG. 6

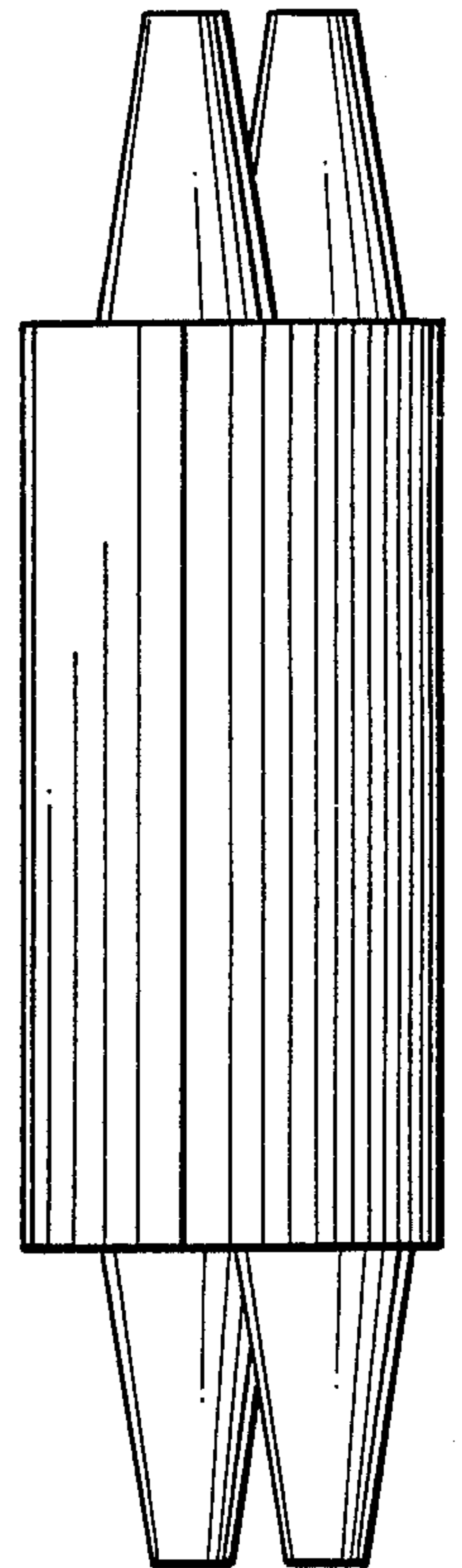

FIG. 8

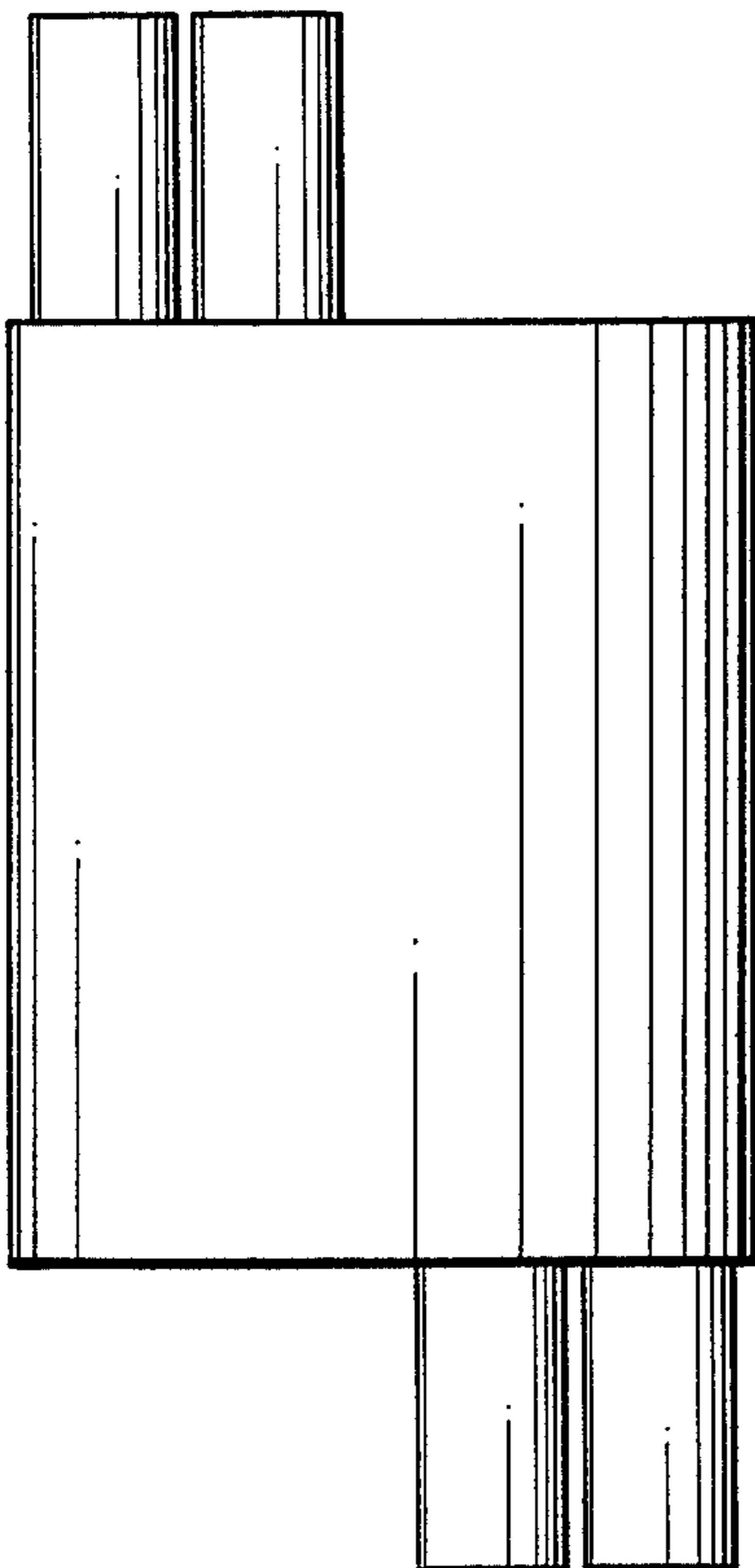

FIG. 7

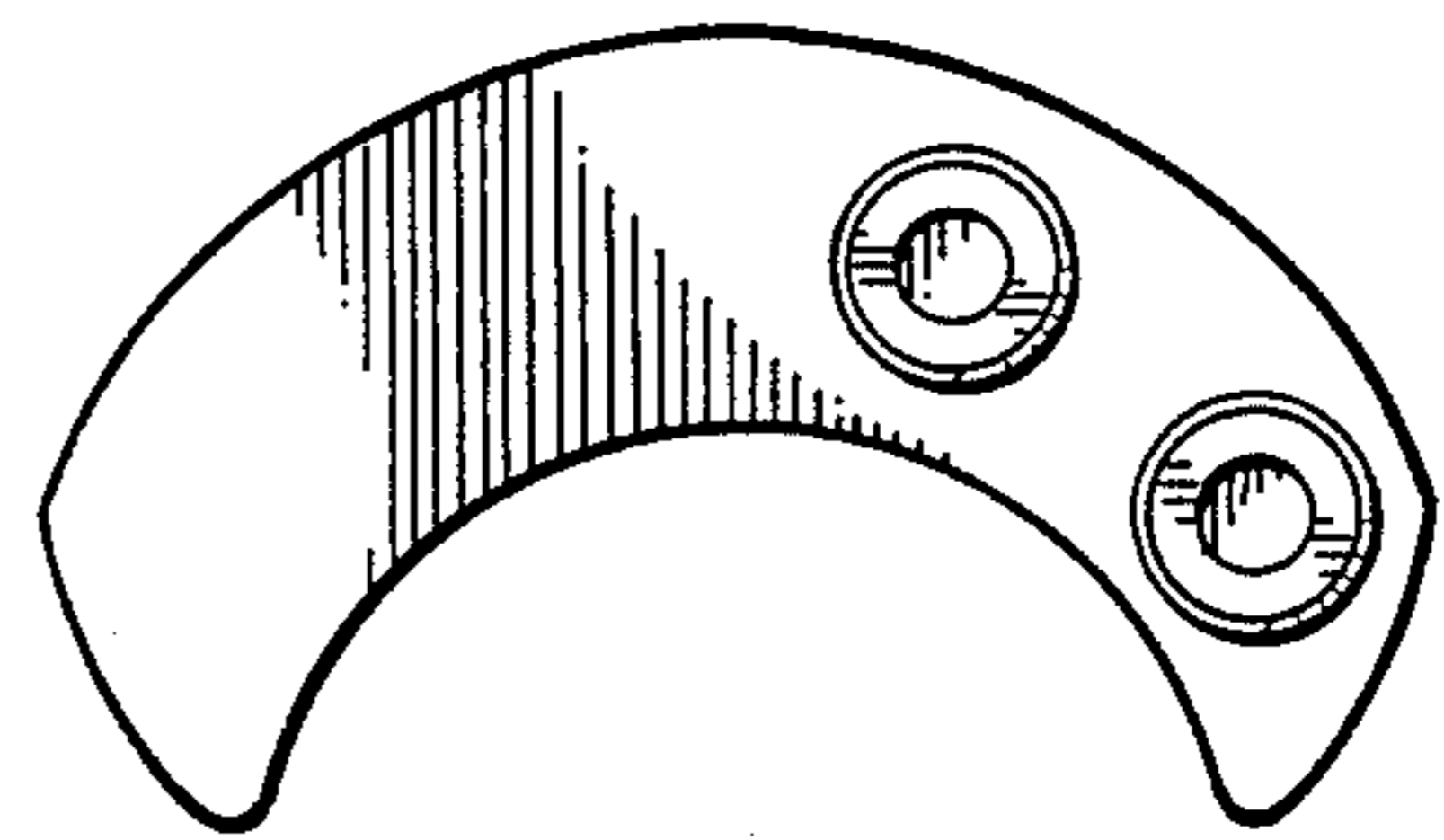

FIG. 9

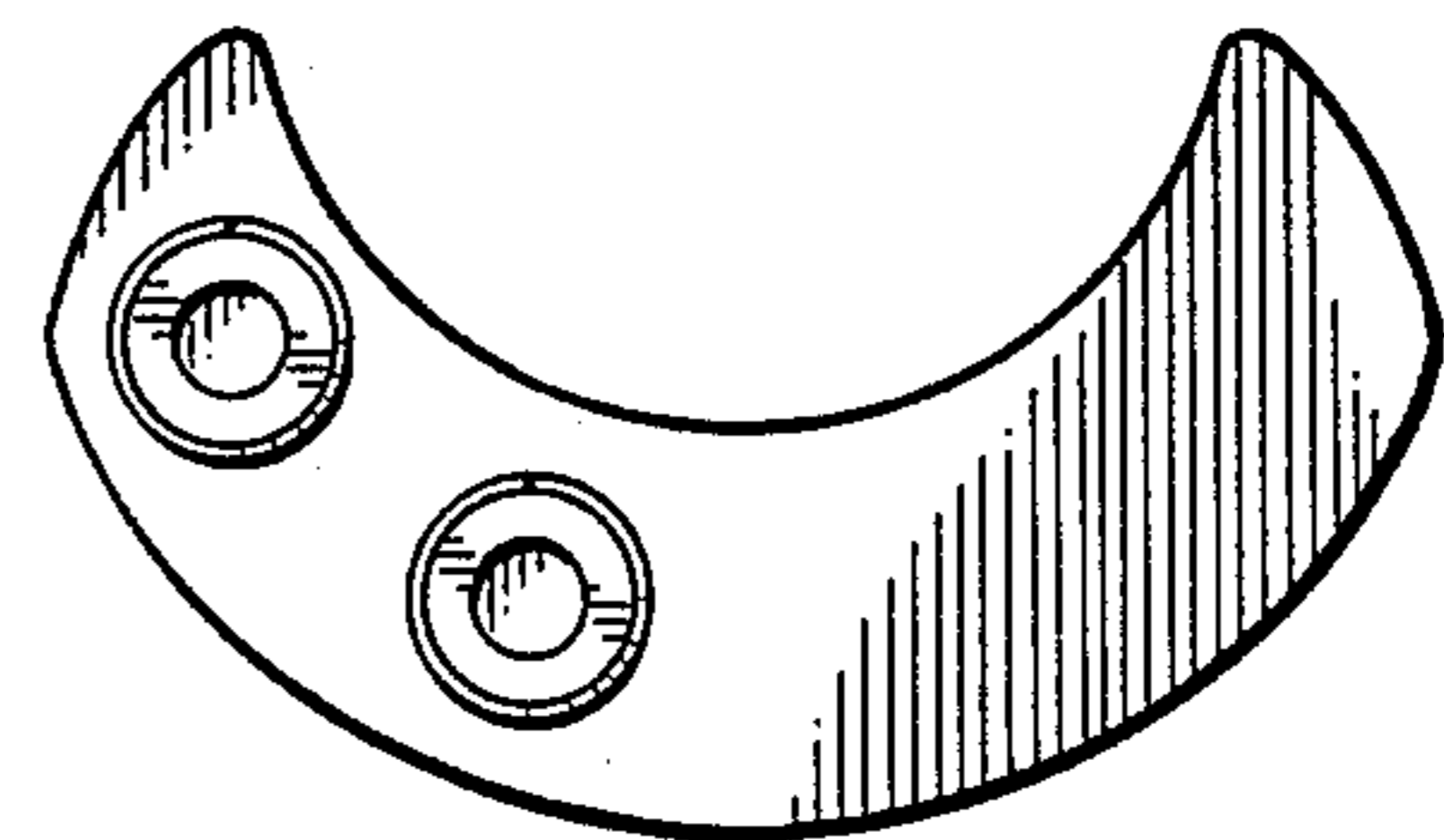

FIG. 10

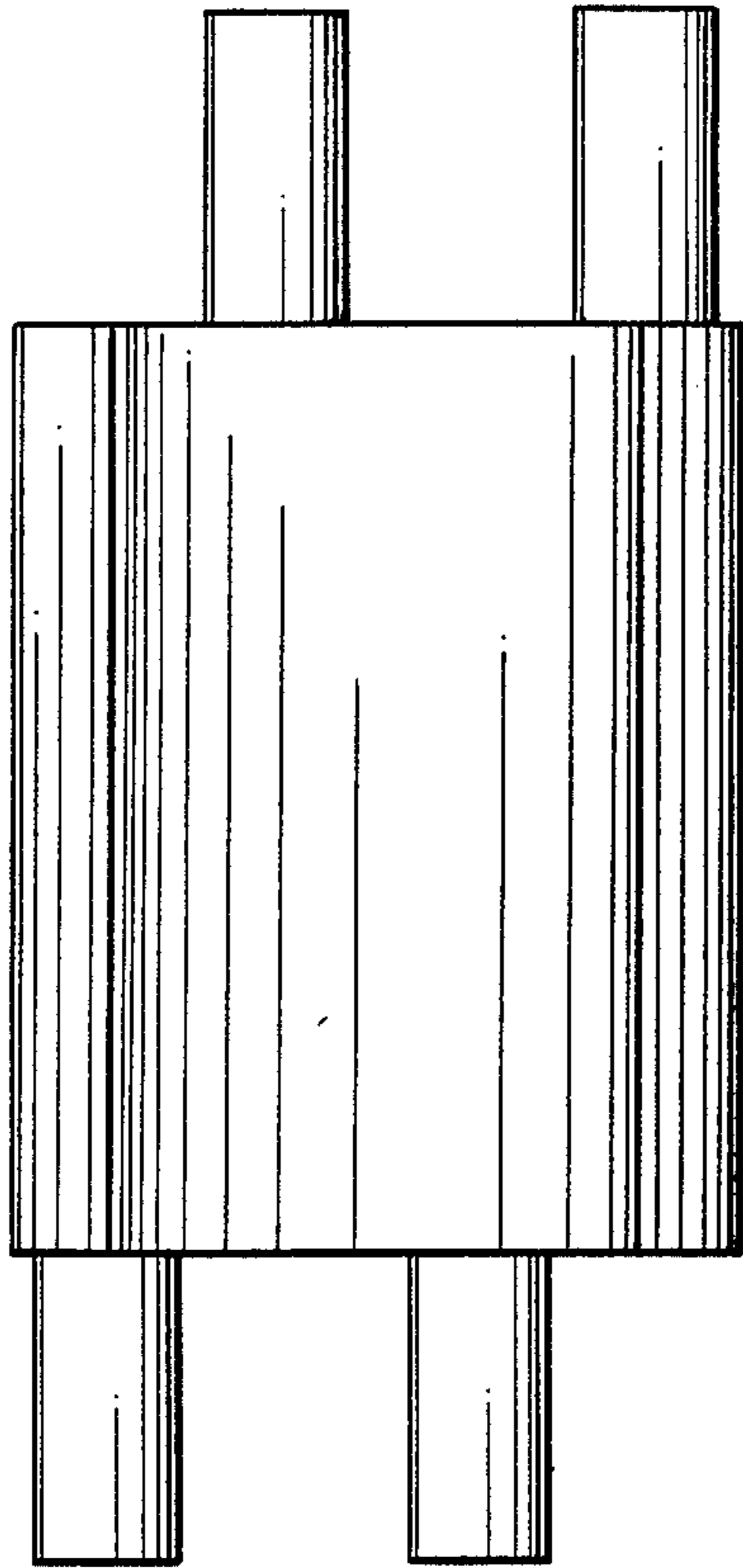

FIG. 11

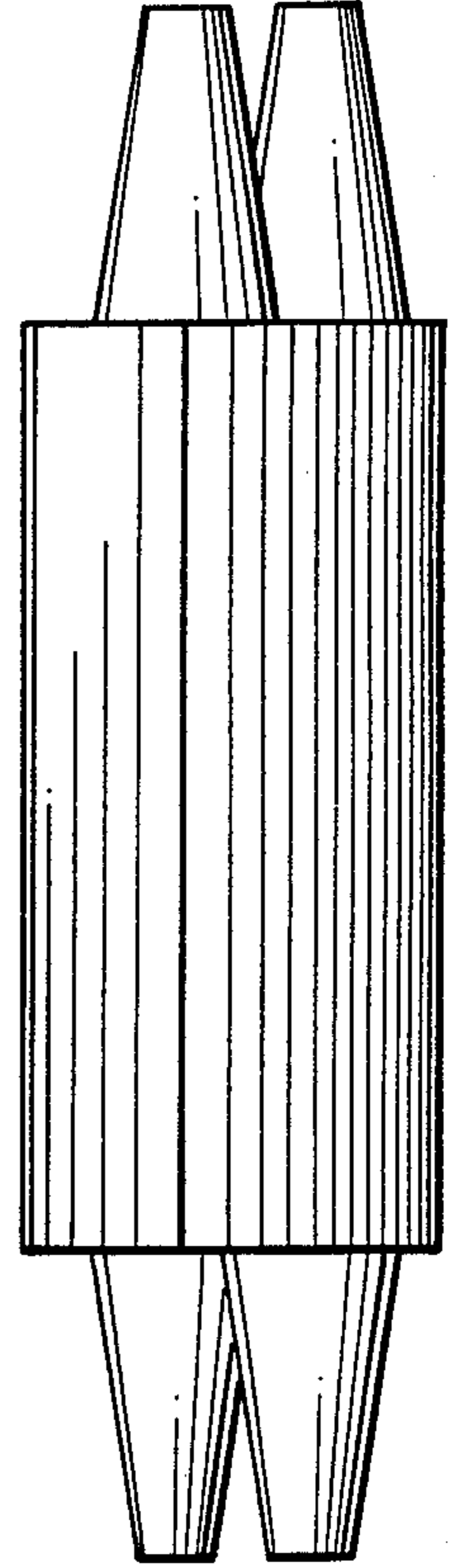

FIG. 13

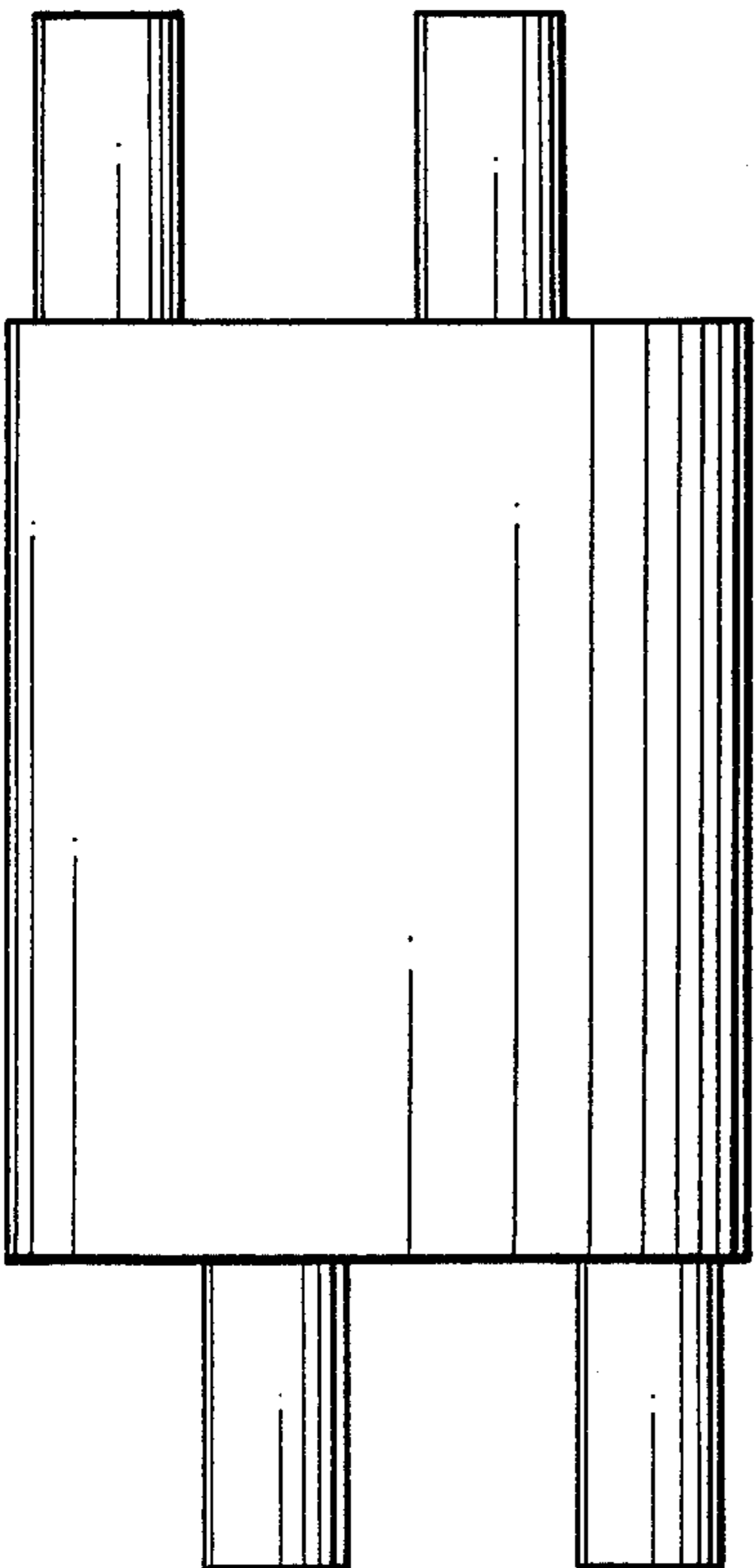

FIG. 12

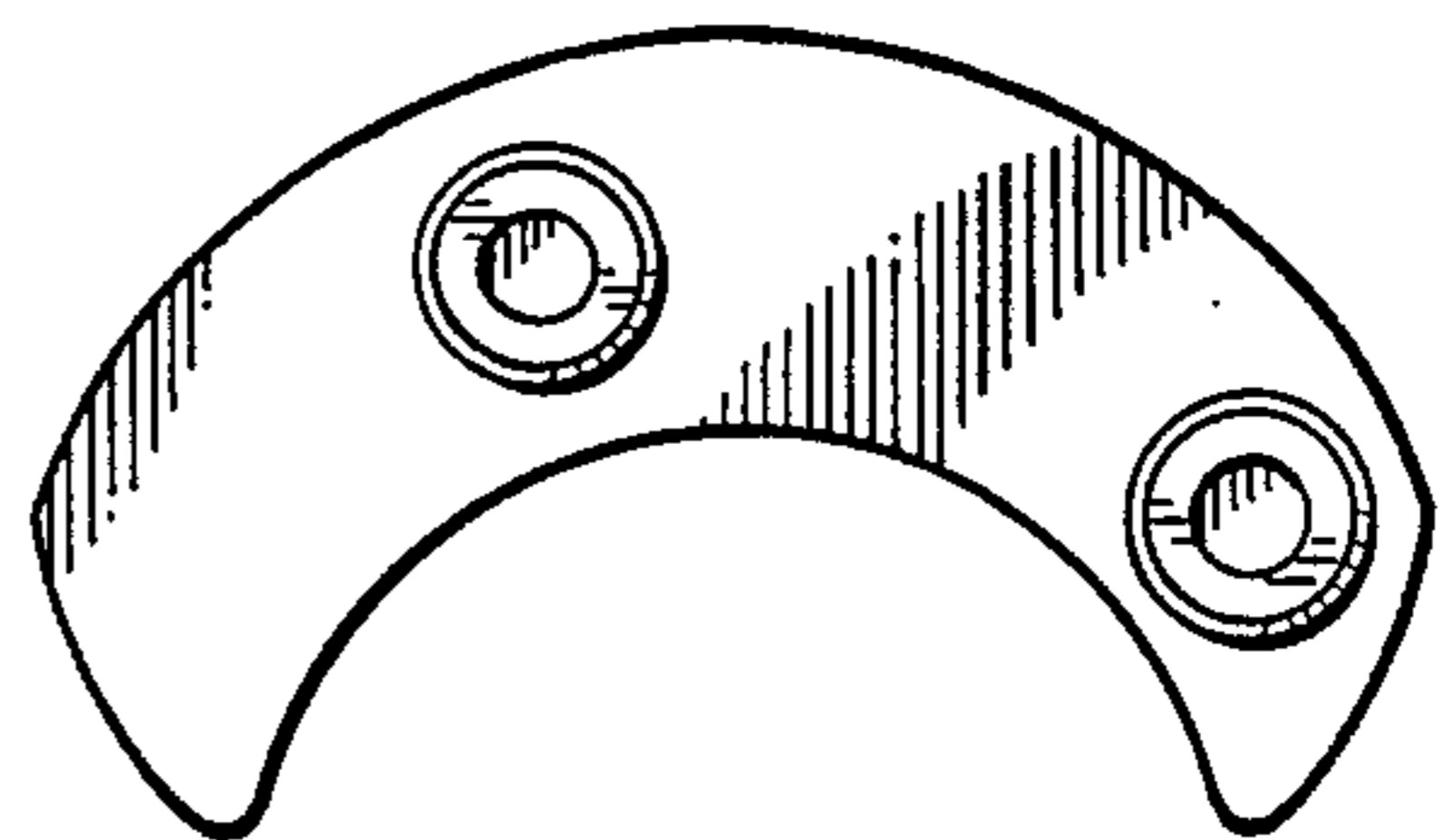

FIG. 14

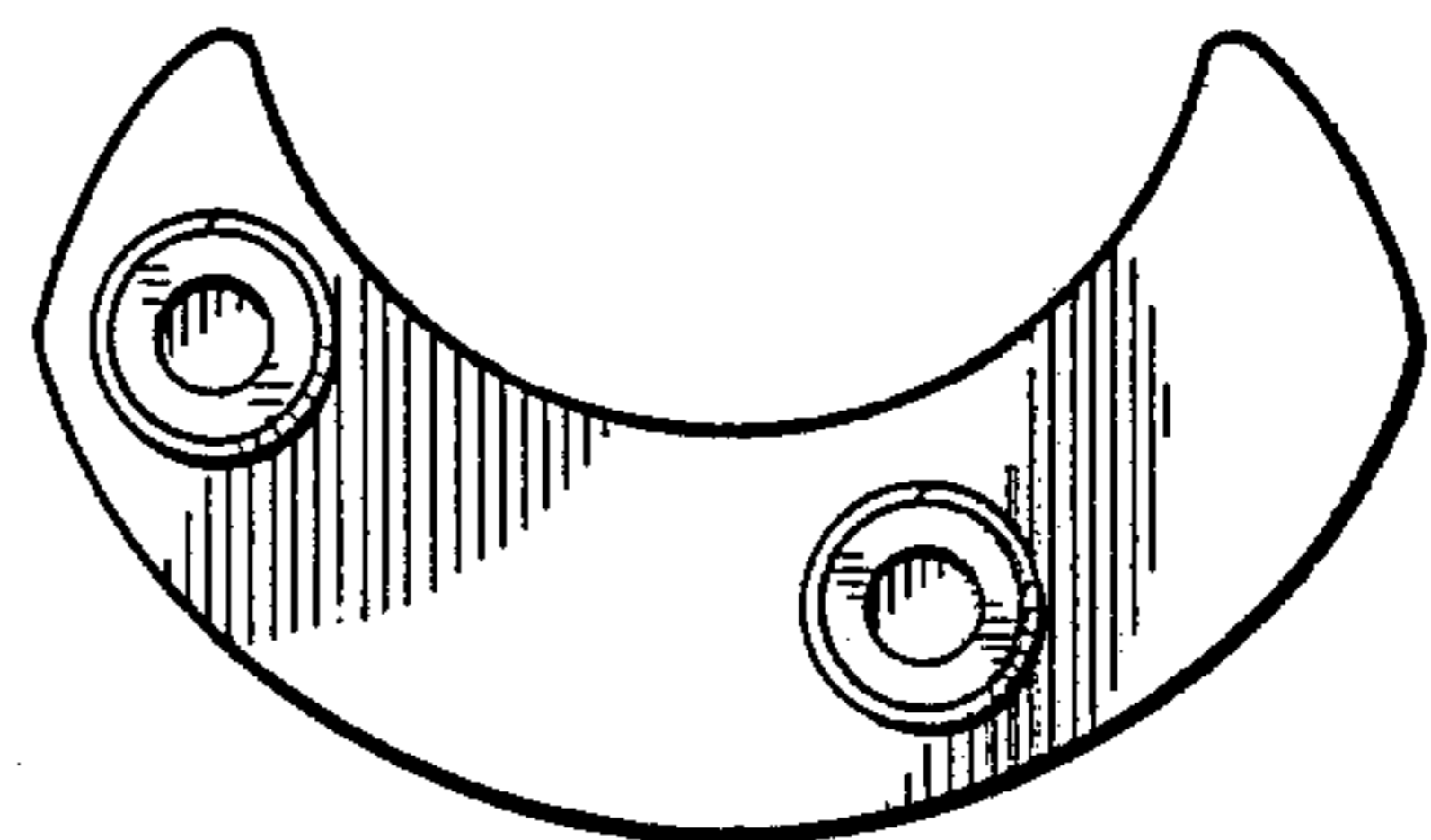

FIG. 15

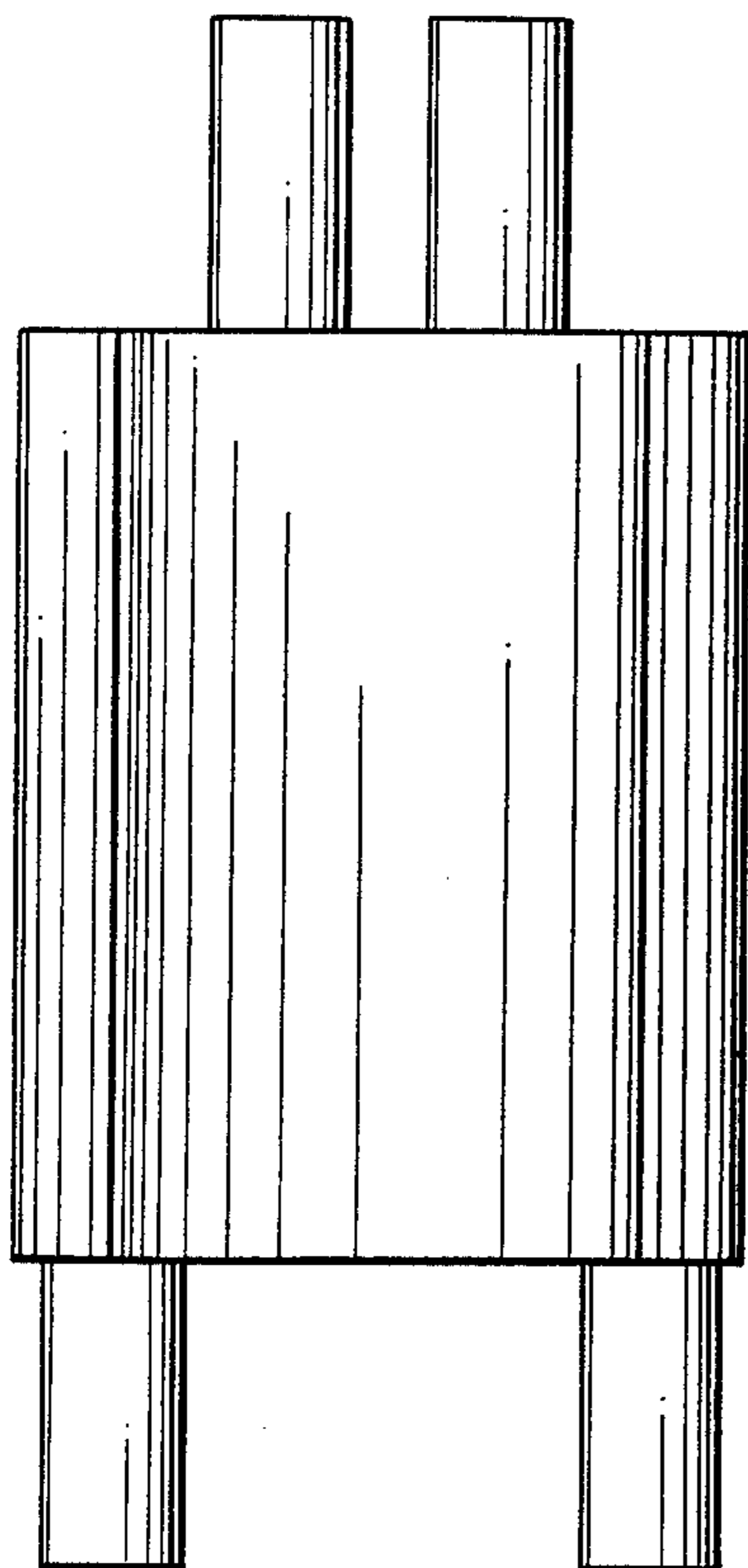

FIG. 16

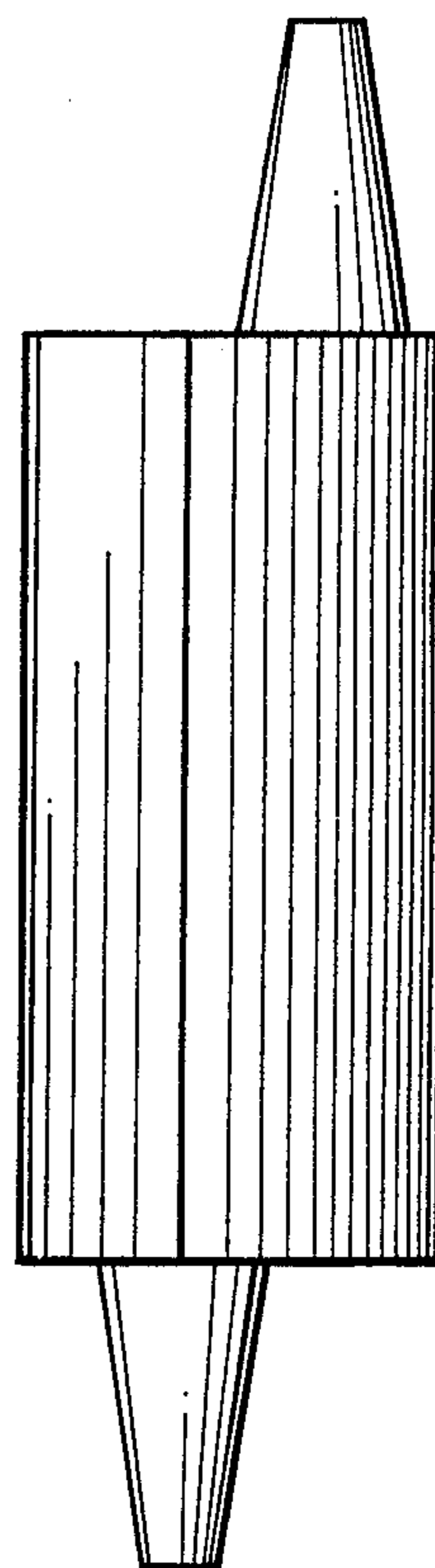

FIG. 18

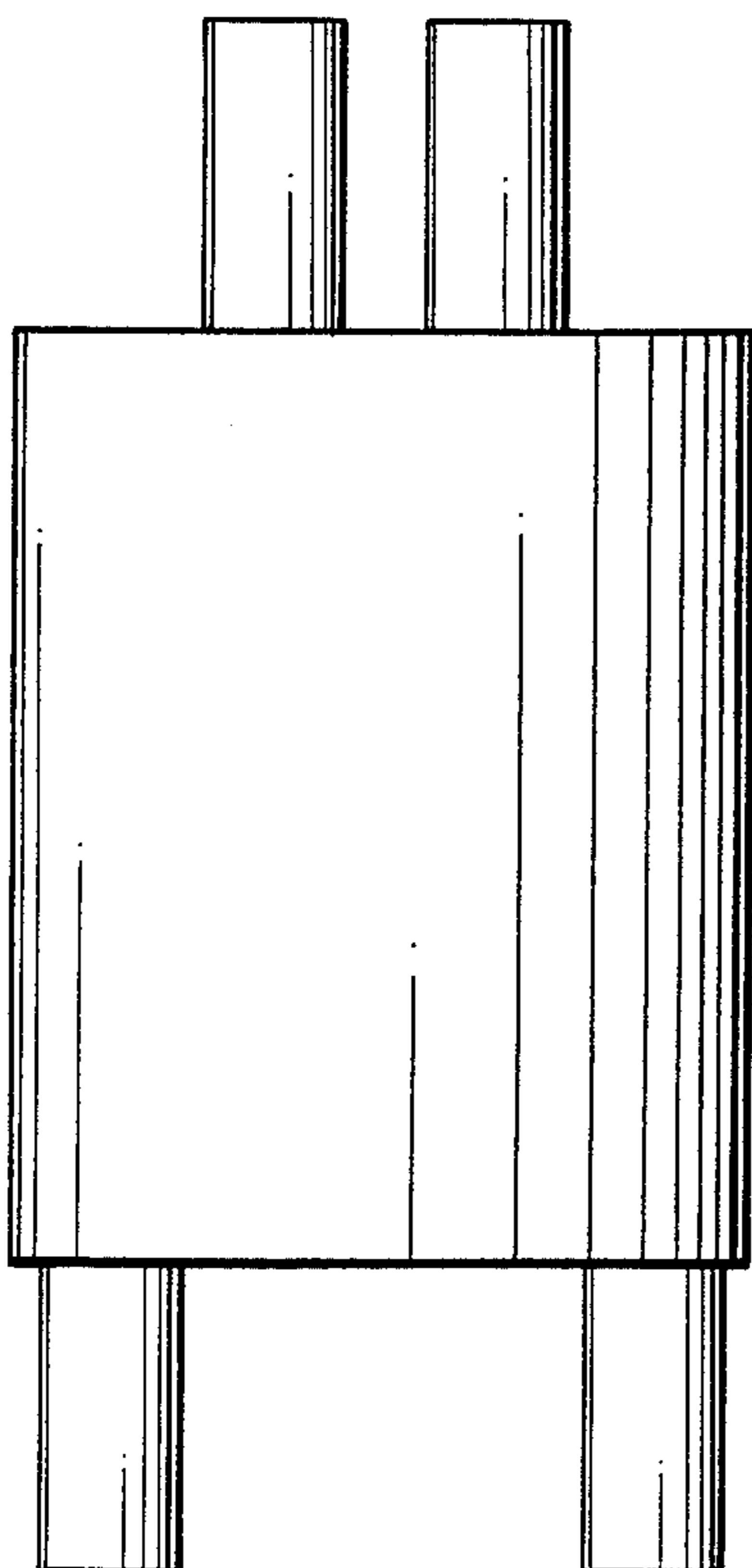

FIG. 17

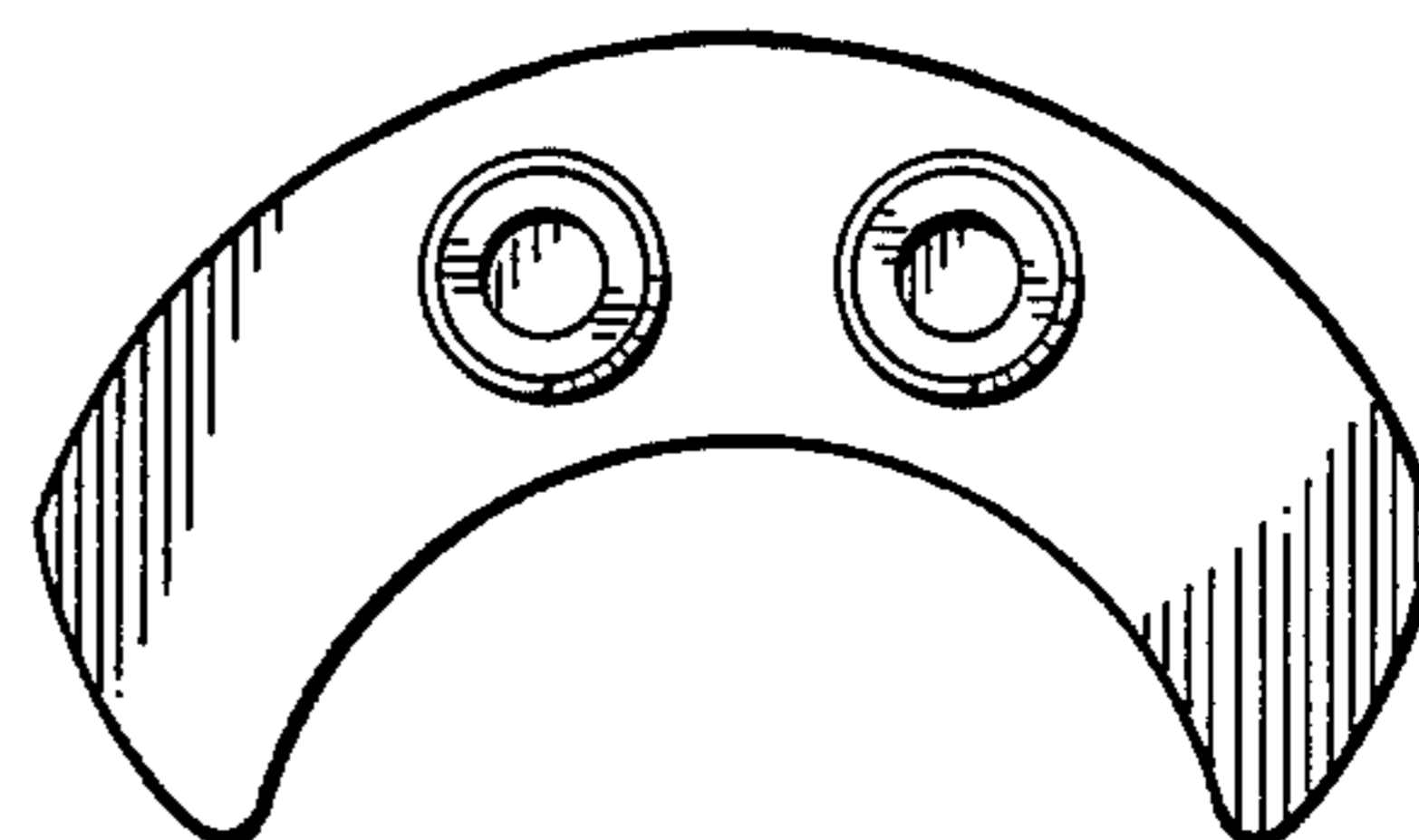

FIG. 19

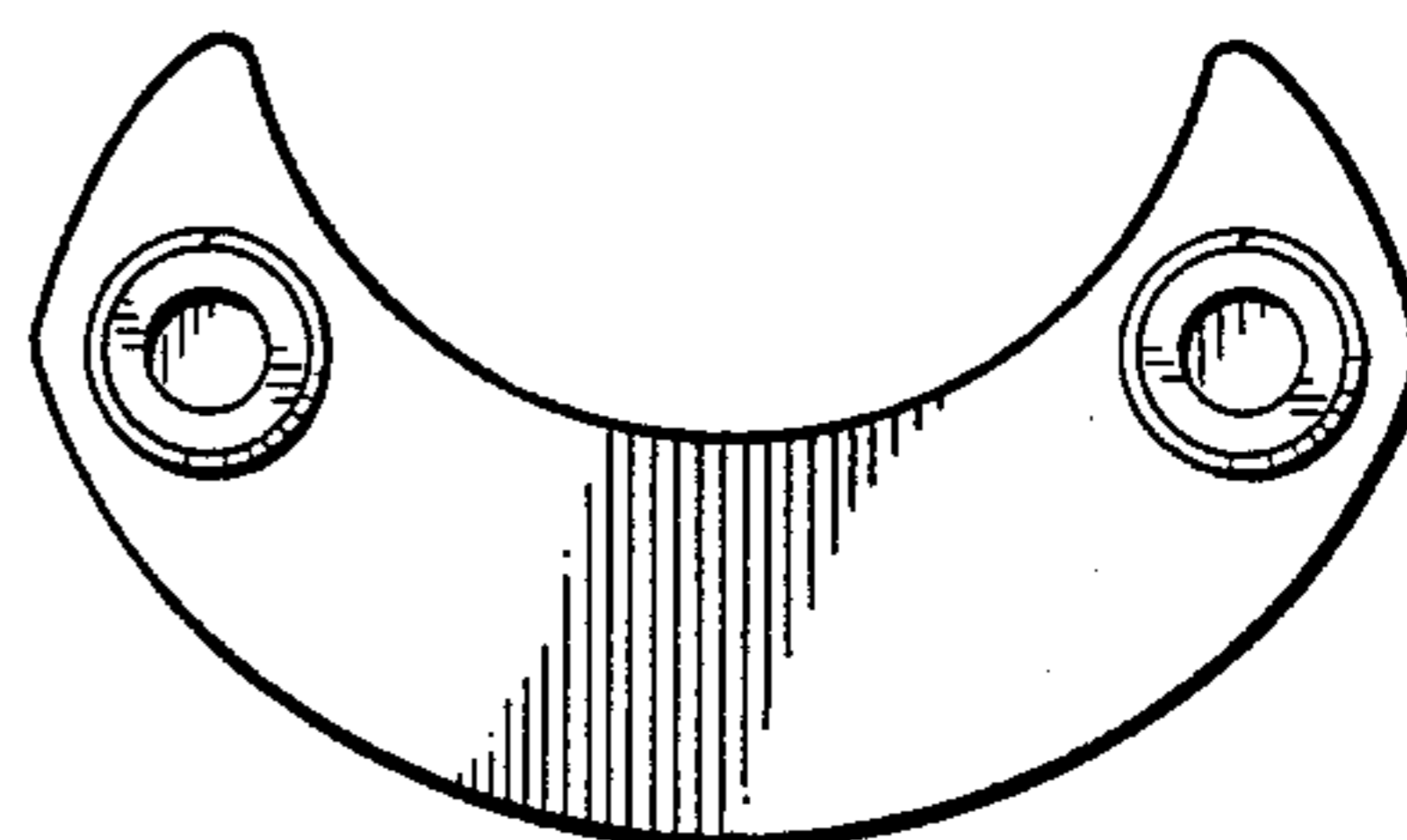

FIG. 20

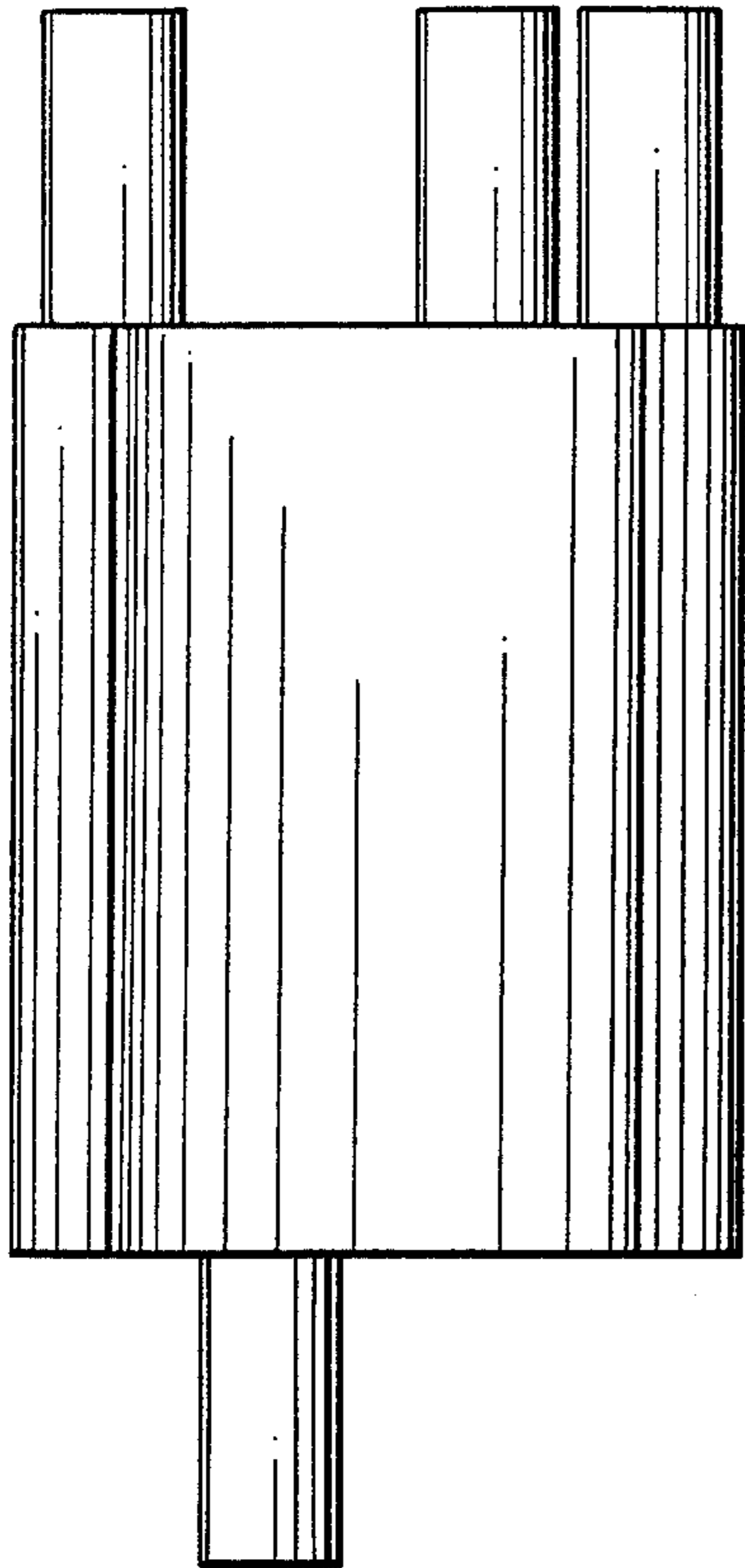

FIG. 21

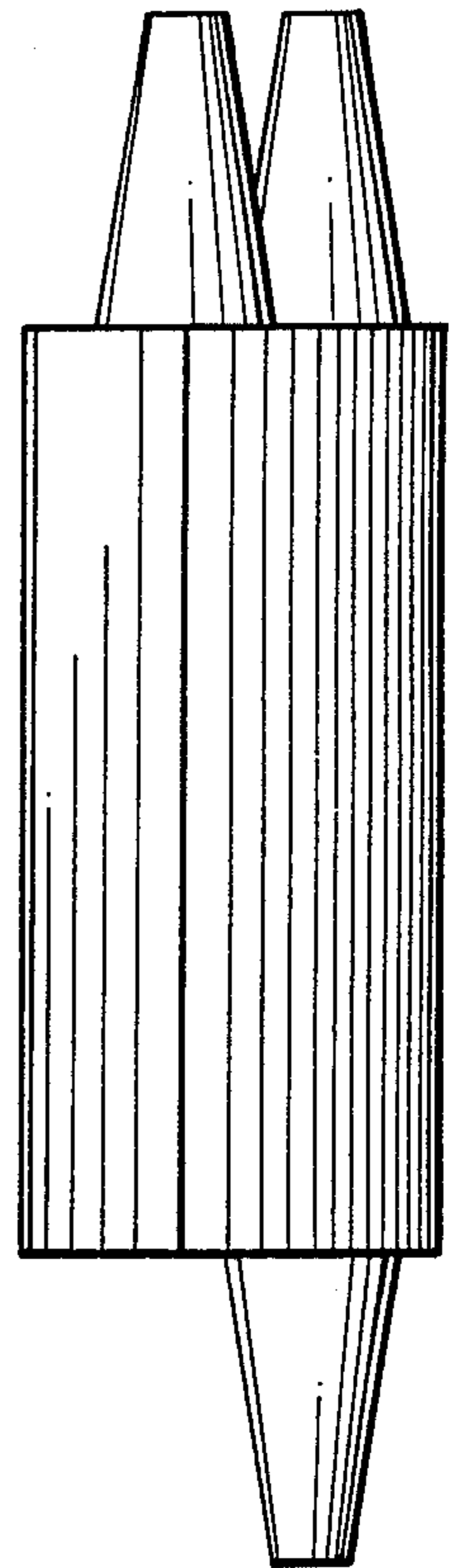

FIG. 23

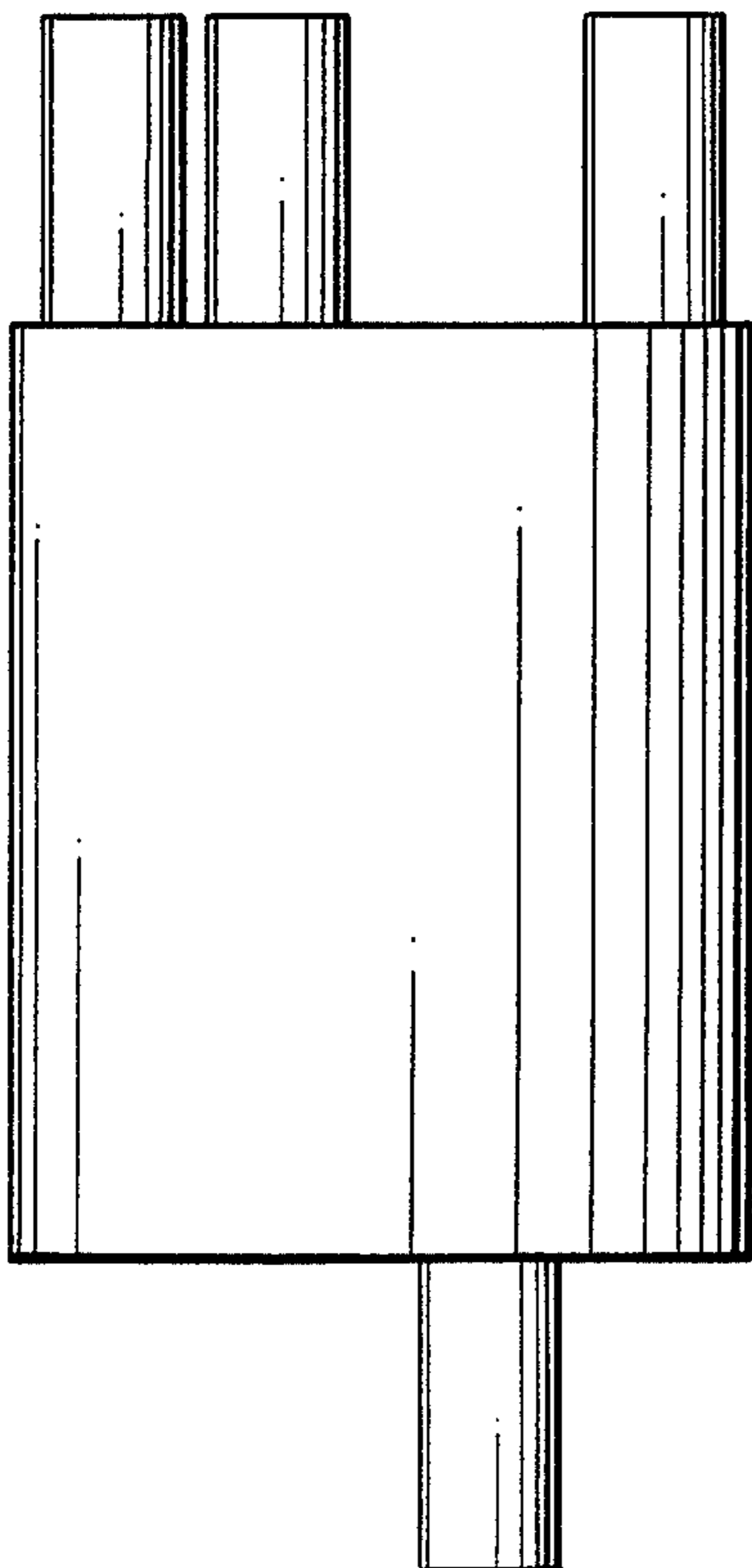

FIG. 22

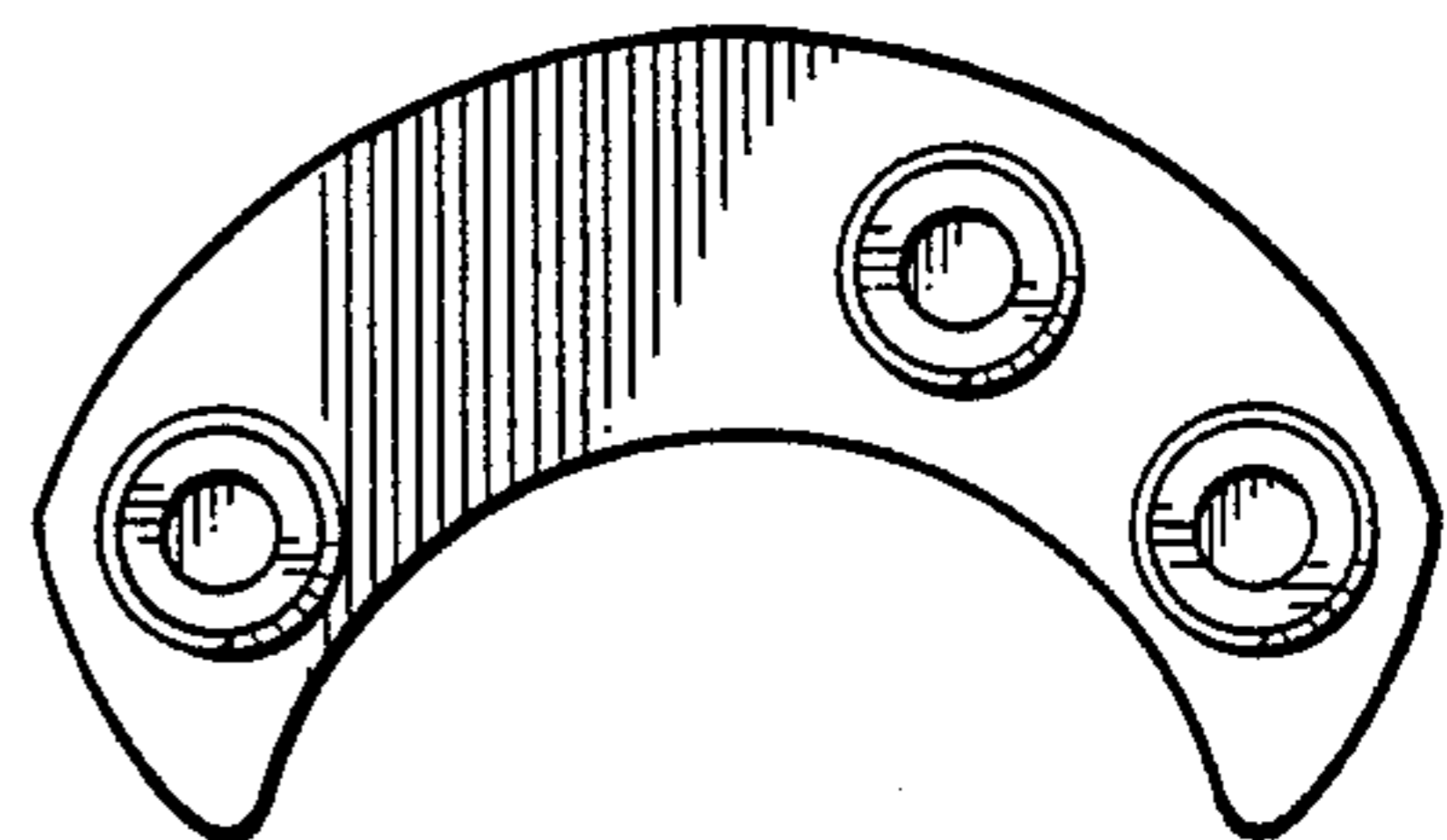

FIG. 24

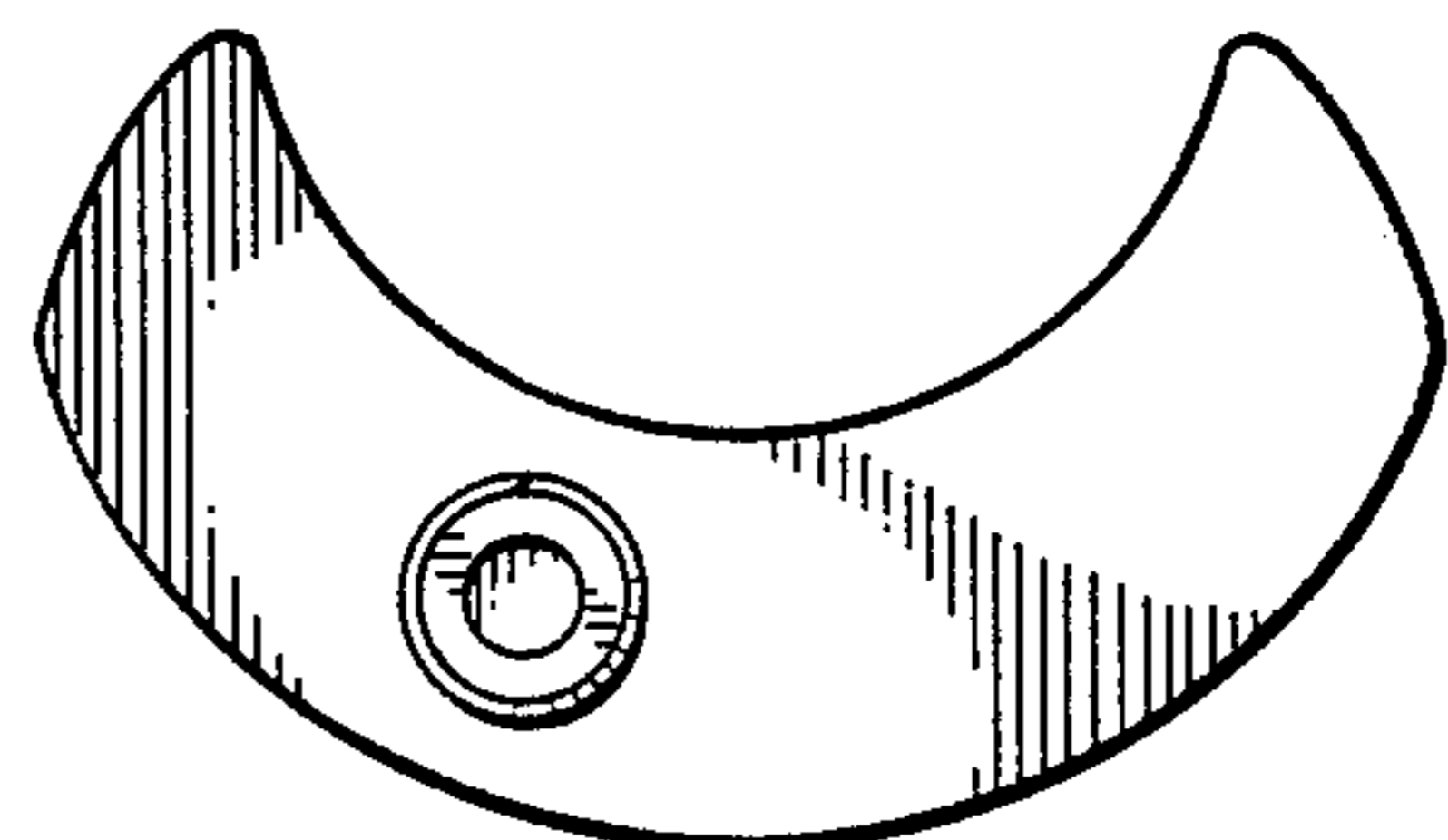

FIG. 25