

[54] **FLUID DISPENSING CASSETTE FOR DISPENSING DOSES OF STERILIZING LIQUID**

[75] **Inventors: Harold R. Williams, Capistrano Beach; Jay Wilson, Portola Valley, both of Calif.**

[73] **Assignee: Surgikos, Inc., Arlington, Tex.**

[\*\*] **Term: 14 Years**

[21] **Appl. No.: 54,662**

[22] **Filed: May 26, 1987**

[52] **U.S. Cl. .... D24/9**

[58] **Field of Search ..... D24/51, 9; 206/370, 206/366, 368, 484, 531, 538; 210/300; 422/310, 300; 222/82, 81, 94, 95; 128/203, 15**

[56] **References Cited**

**U.S. PATENT DOCUMENTS**

- D. 250,543 12/1978 Lewis ..... D24/9
- D. 295,074 4/1988 Jerge et al. .... D24/9

D. 295,075 4/1988 Jerge et al. .... D24/9

*Primary Examiner*—A. Hugo Word  
*Assistant Examiner*—Stella M. Reid  
*Attorney, Agent, or Firm*—Joseph F. Shirtz

[57] **CLAIM**

The ornamental design for a fluid dispensing cassette for dispensing doses of sterilizing liquid, as shown.

**DESCRIPTION**

FIG. 1 is a top perspective view of a fluid dispensing cassette for dispensing doses of sterilizing liquid, showing our new design;  
 FIG. 2 is a bottom perspective view thereof;  
 FIG. 3 is a top plan view thereof;  
 FIG. 4 is a bottom plan view thereof;  
 FIG. 5 is a side elevational view thereof;  
 FIG. 6 is a side elevational view thereof, opposite that shown in FIG. 5;  
 FIG. 7 is an end elevational view thereof; and  
 FIG. 8 is an end elevational view thereof, opposite that shown in FIG. 7.

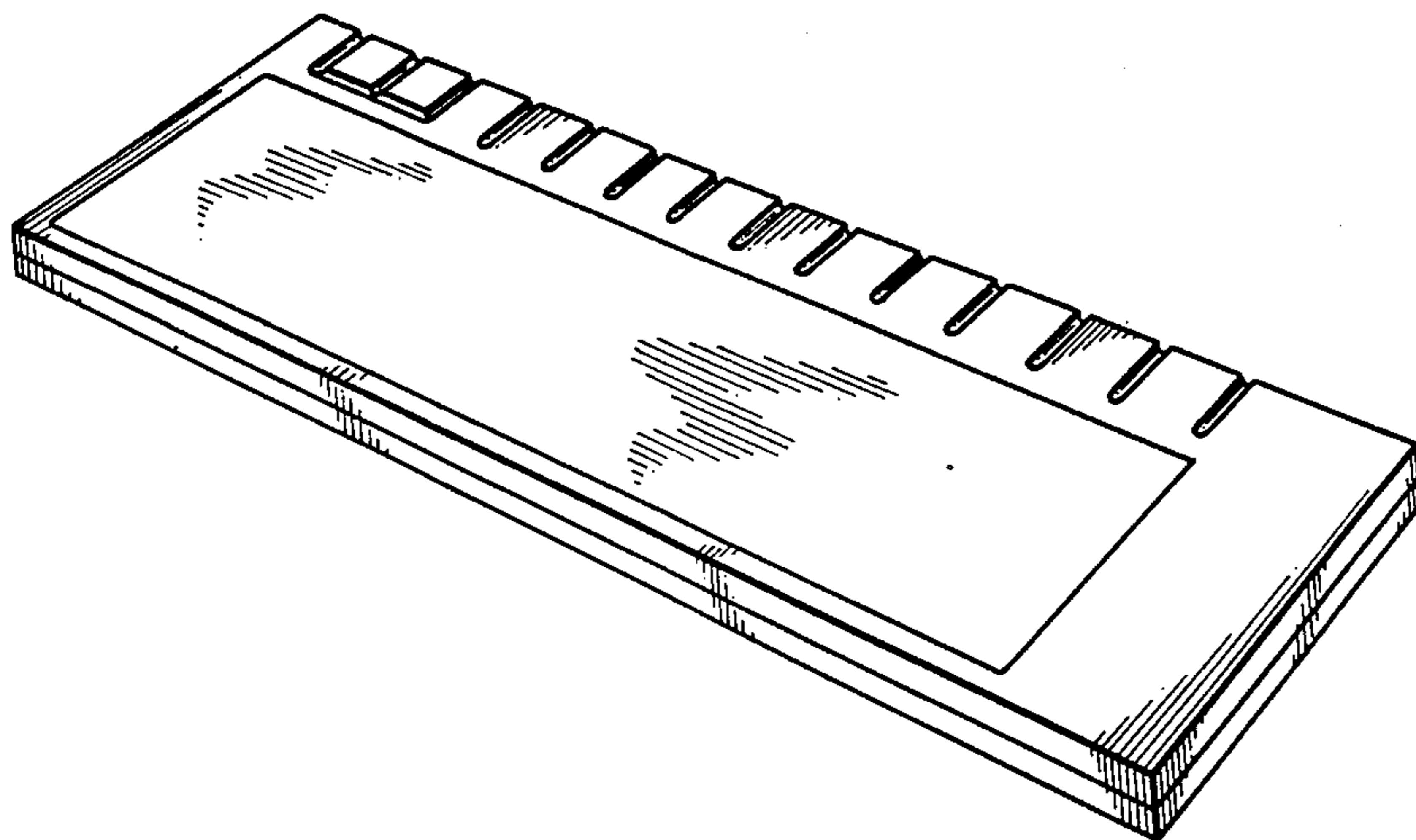

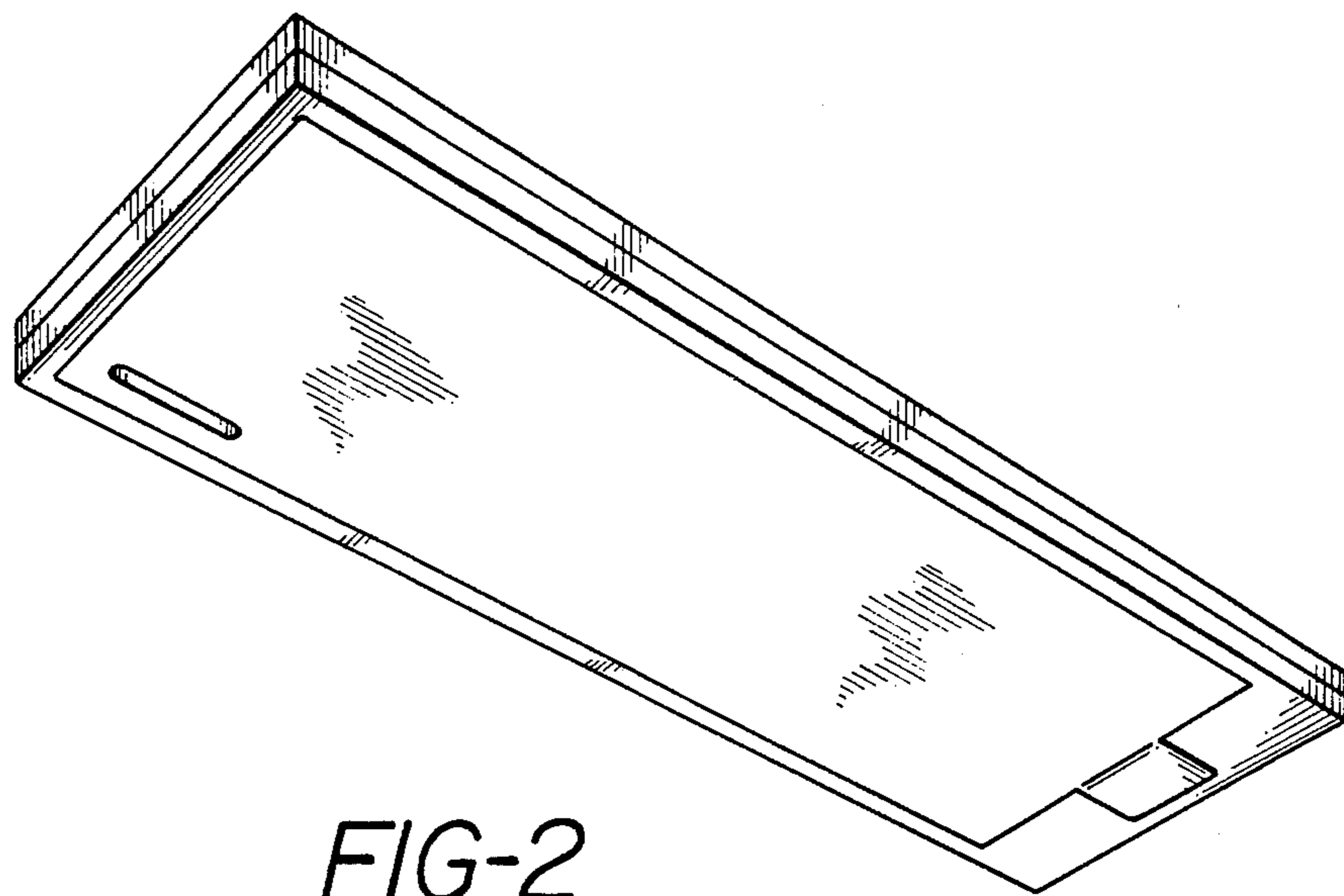
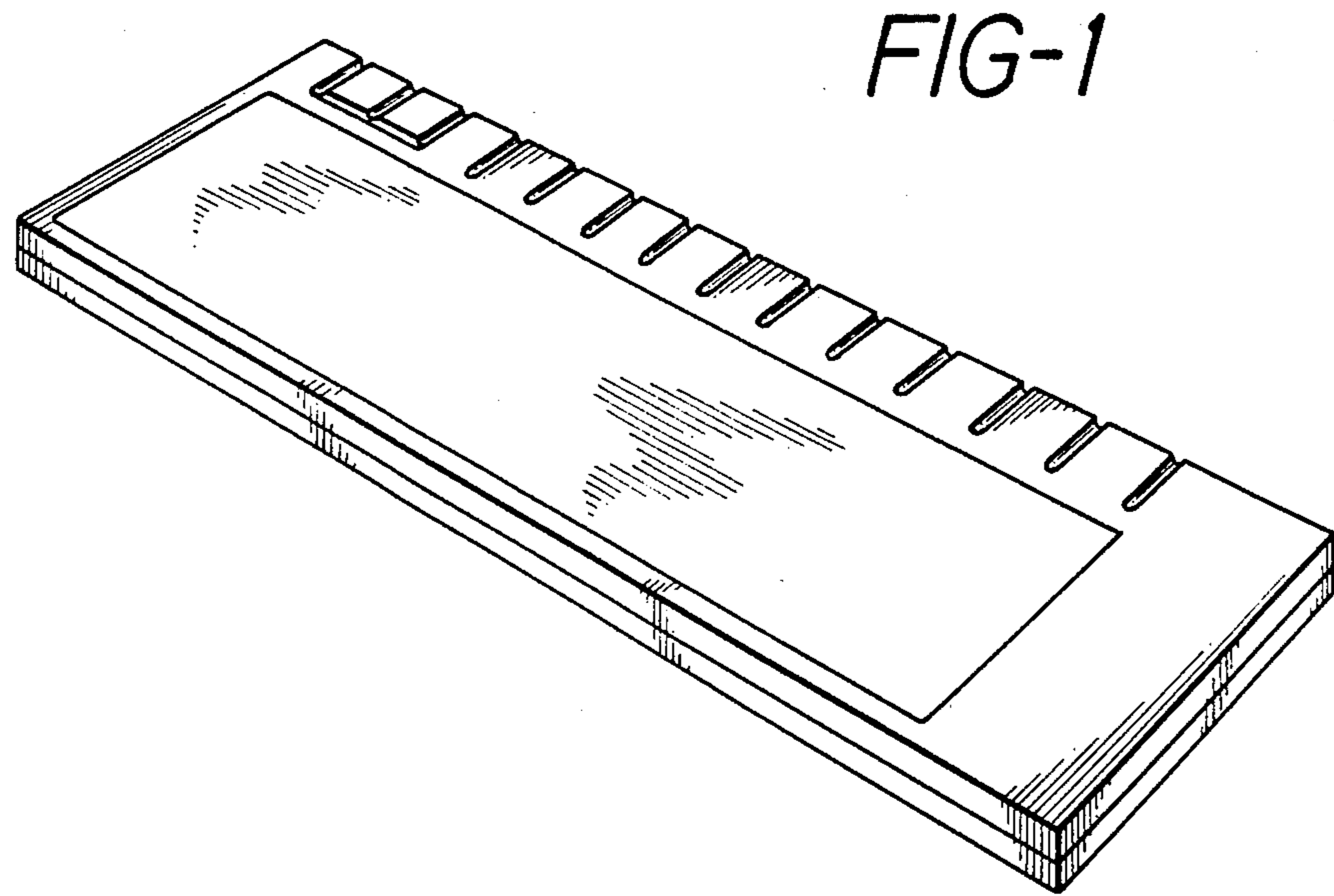

FIG-3

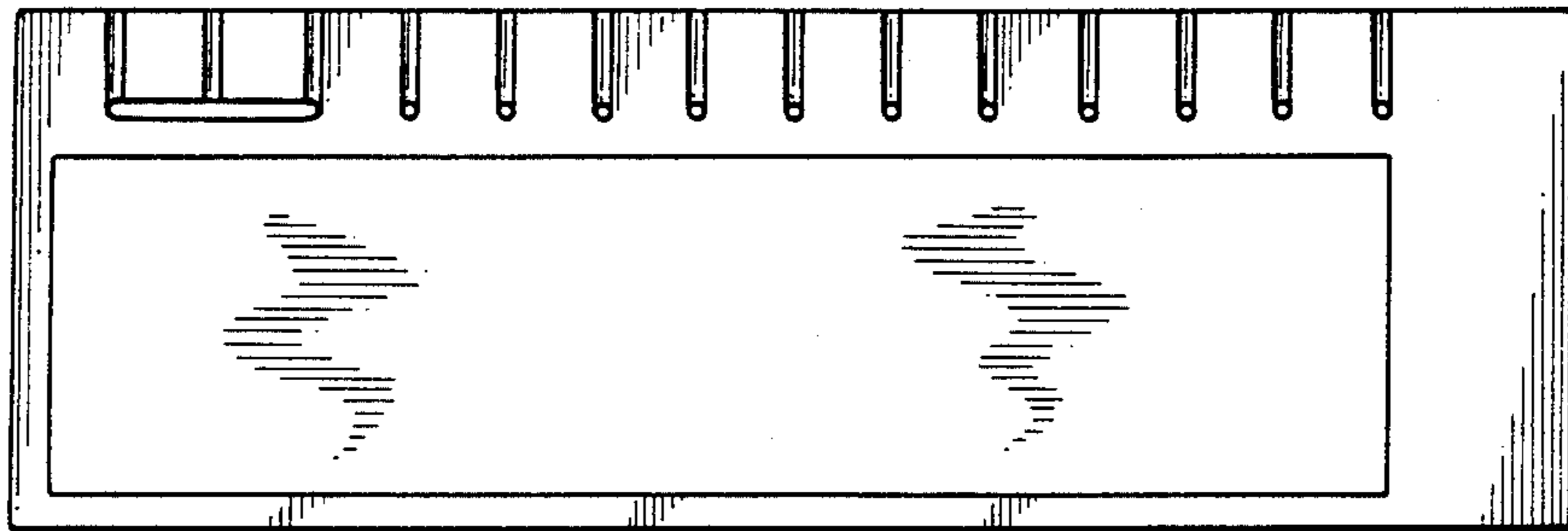

FIG-4

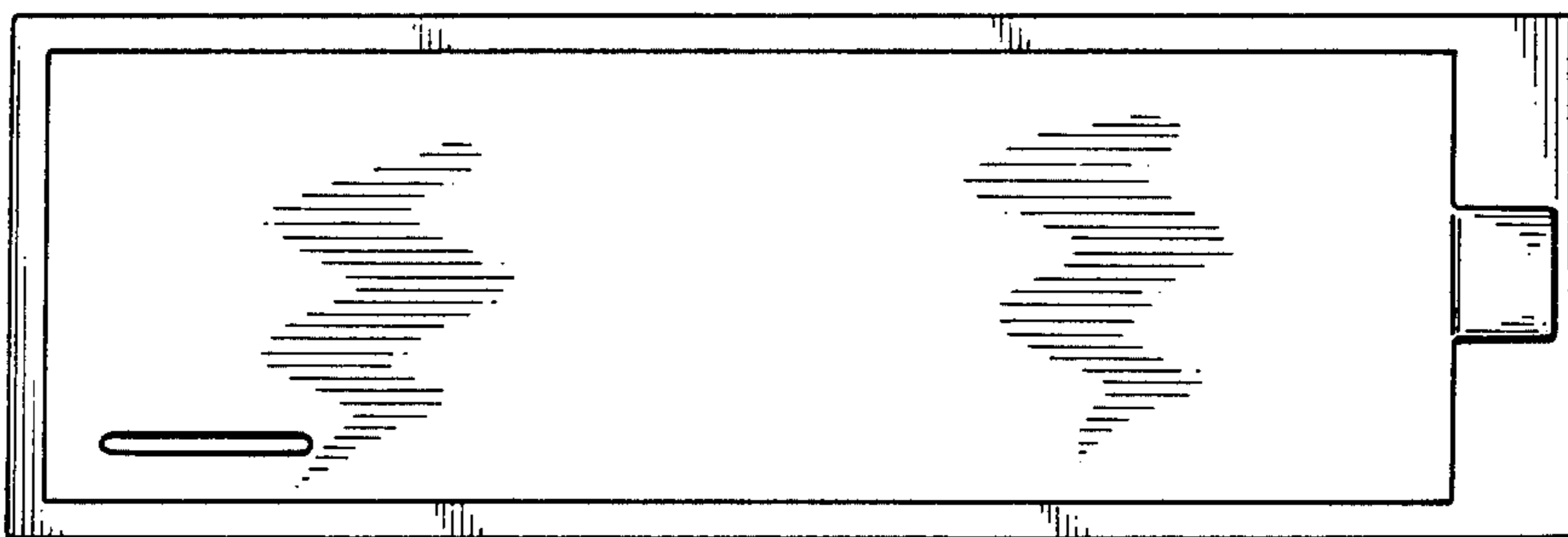

FIG-5

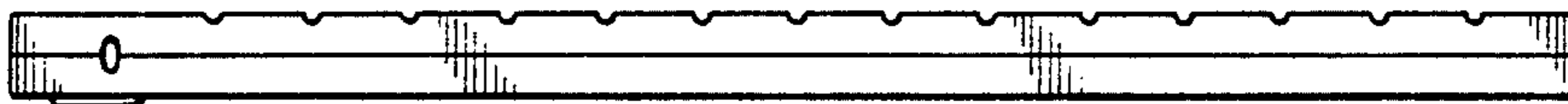

FIG-6

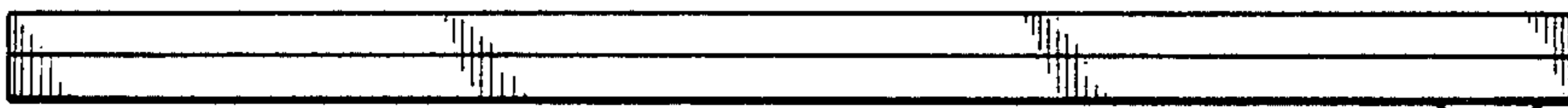

FIG-7



FIG-8

