

[54] GLASS FIRESCREEN DOOR UNIT

[75] Inventor: Charles P. Becker, Jr., St. Louis County, Mo.

[73] Assignee: Charles Becker Associates, Inc., Fenton, Mo.

[**] Term: 14 Years

[21] Appl. No.: 939,472

[22] Filed: Dec. 8, 1986

[52] U.S. Cl. D23/406

[58] Field of Search D23/386, 403, 405, 406; 126/544, 545, 546, 547, 548, 549, 550, 551; 49/366

[56] References Cited

U.S. PATENT DOCUMENTS

D. 286,176	10/1986	Catania et al.	D23/406
D. 290,392	6/1987	Coscione et al.	D23/406
4,026,264	5/1977	Henriques	126/549
4,027,650	6/1977	Edwards	126/548

OTHER PUBLICATIONS

Custom Firescreen Inc. catalogue, p. 2, Genesis II, Antique Brass (150), bottom, right side of page.

Primary Examiner—James M. Gandy
Assistant Examiner—Lisa Lichtenstein
Attorney, Agent, or Firm—Kalish & Gilster

[57] CLAIM

The ornamental design for a glass firescreen door unit, as shown and described.

DESCRIPTION

FIG. 1 is a perspective view of a glass firescreen door unit showing my new design, the broken line showing of a fireplace surround is for illustrative purposes only and forms no part of the claimed design.

FIG. 2 is a right hand end view thereof, in elevation, the opposite end view being substantially a mirror image thereof.

FIG. 3 is a top plan view thereof.

FIG. 4 is a bottom plan view thereof.

FIG. 5 is a rear elevation view thereof.

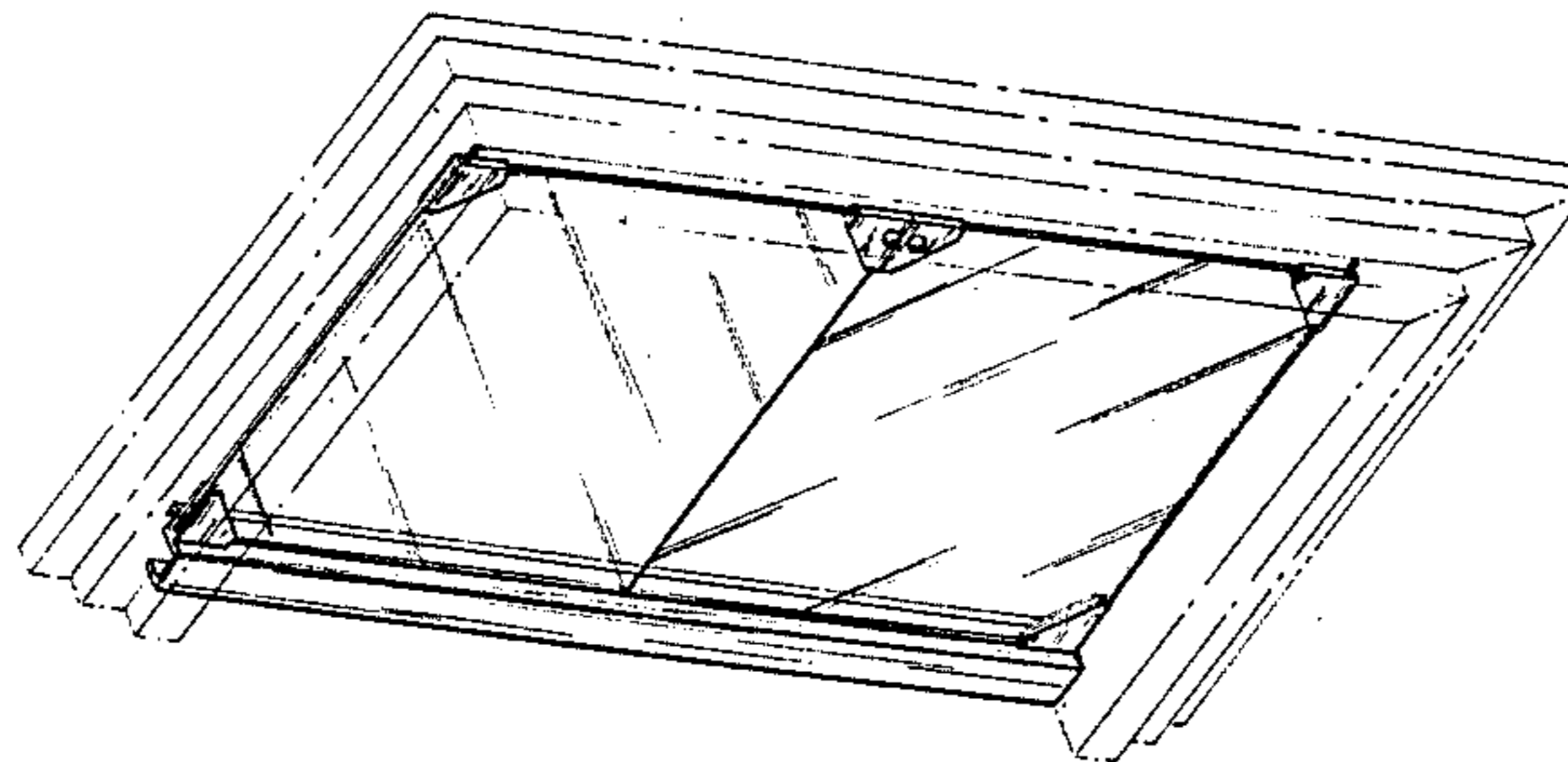

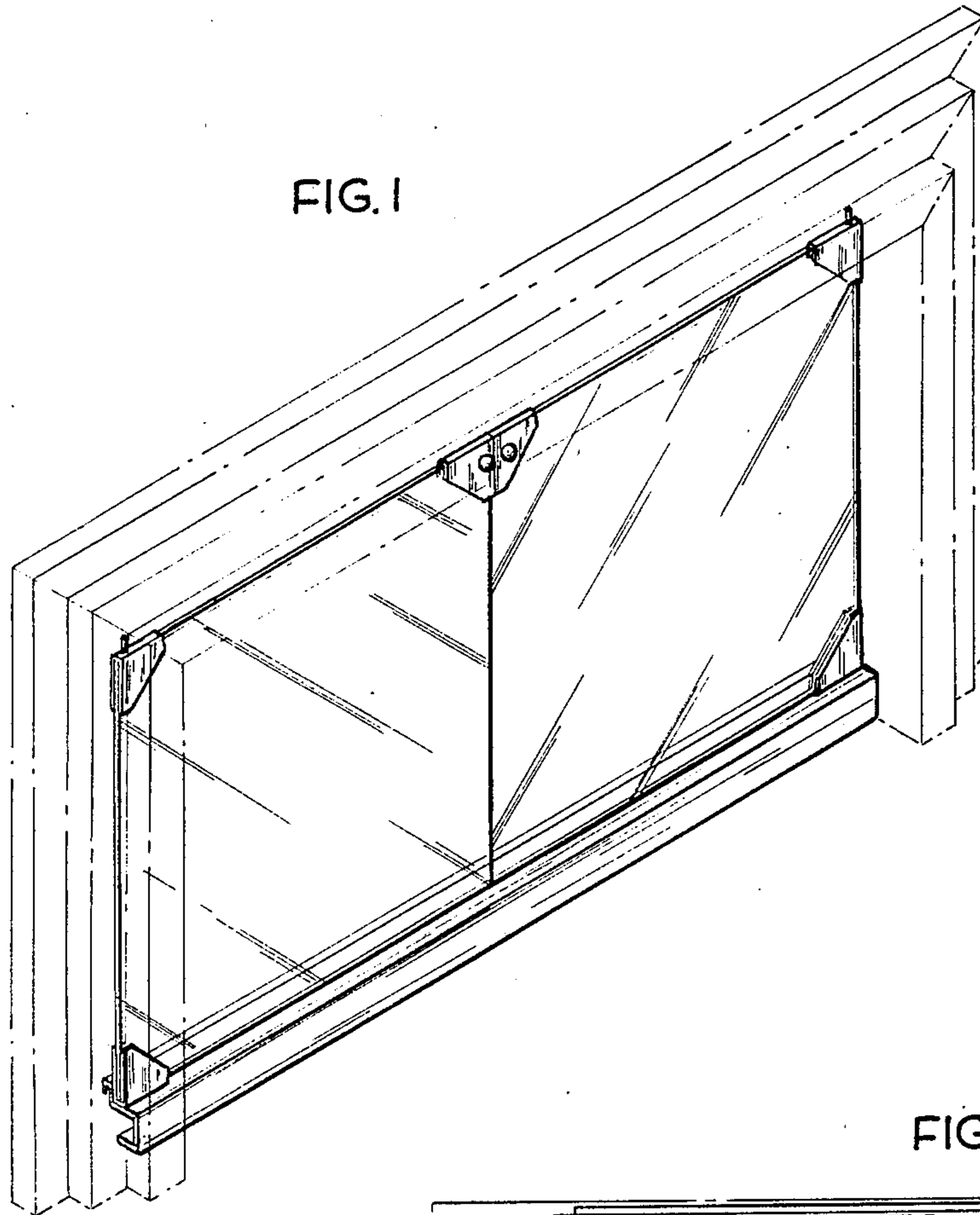

FIG. 1

FIG. 2

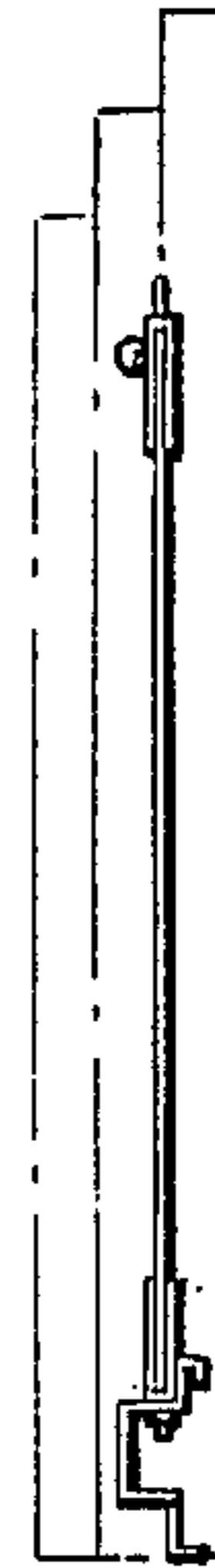

FIG. 3

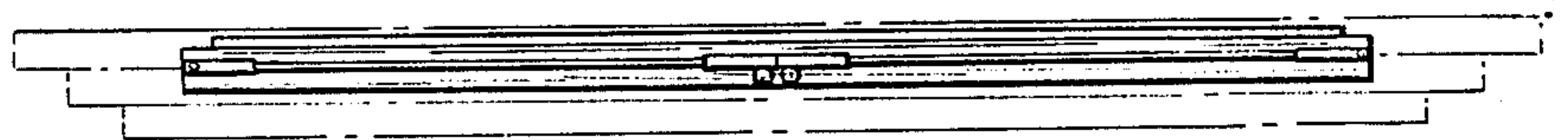

FIG. 4

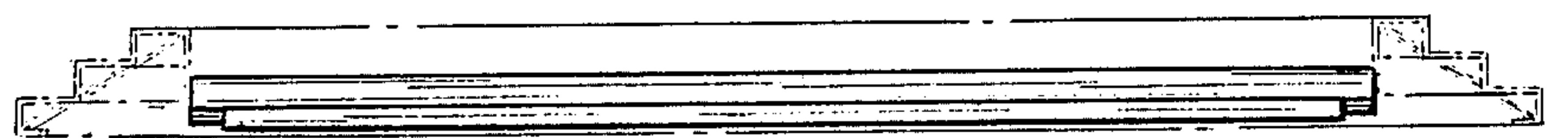
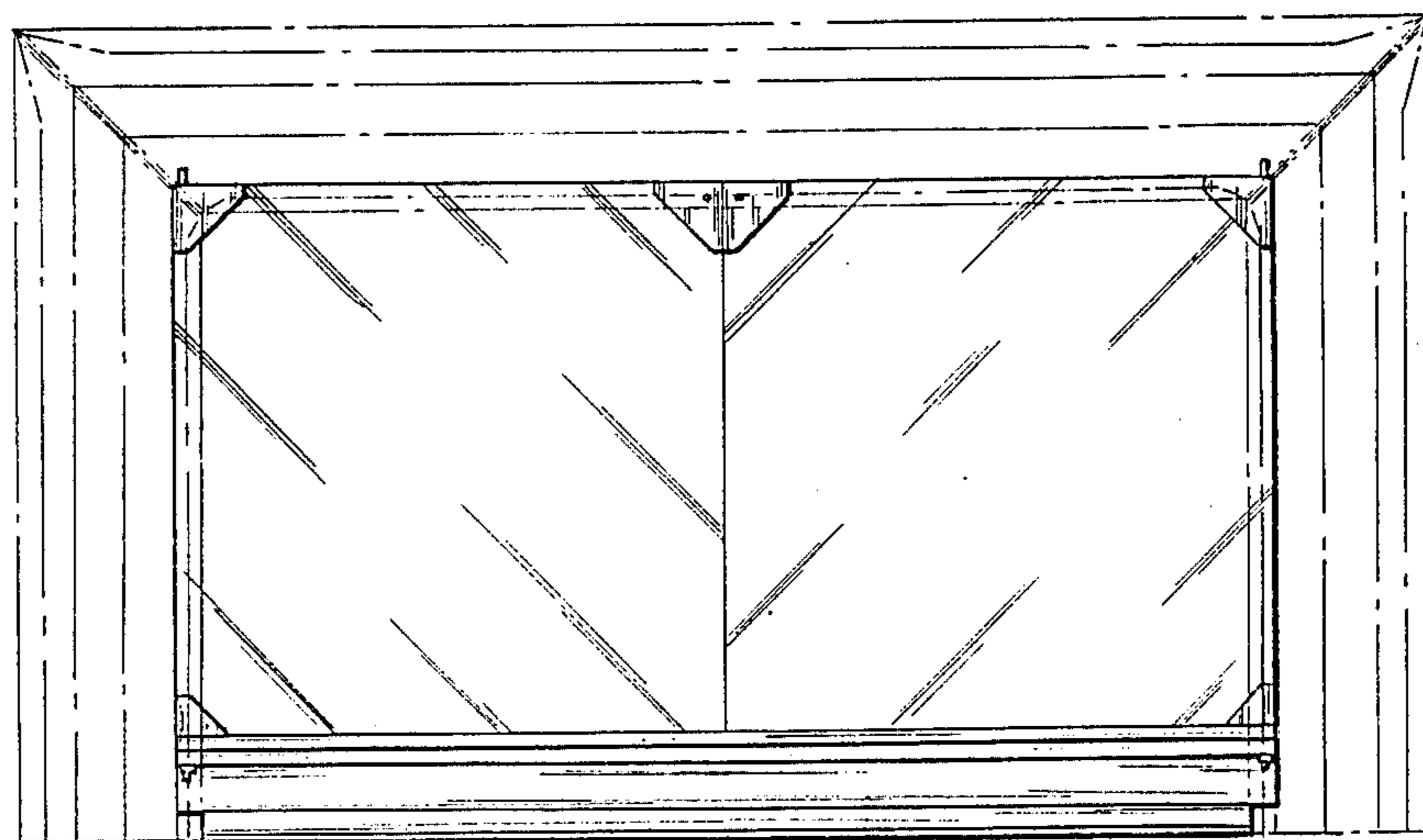

FIG. 5



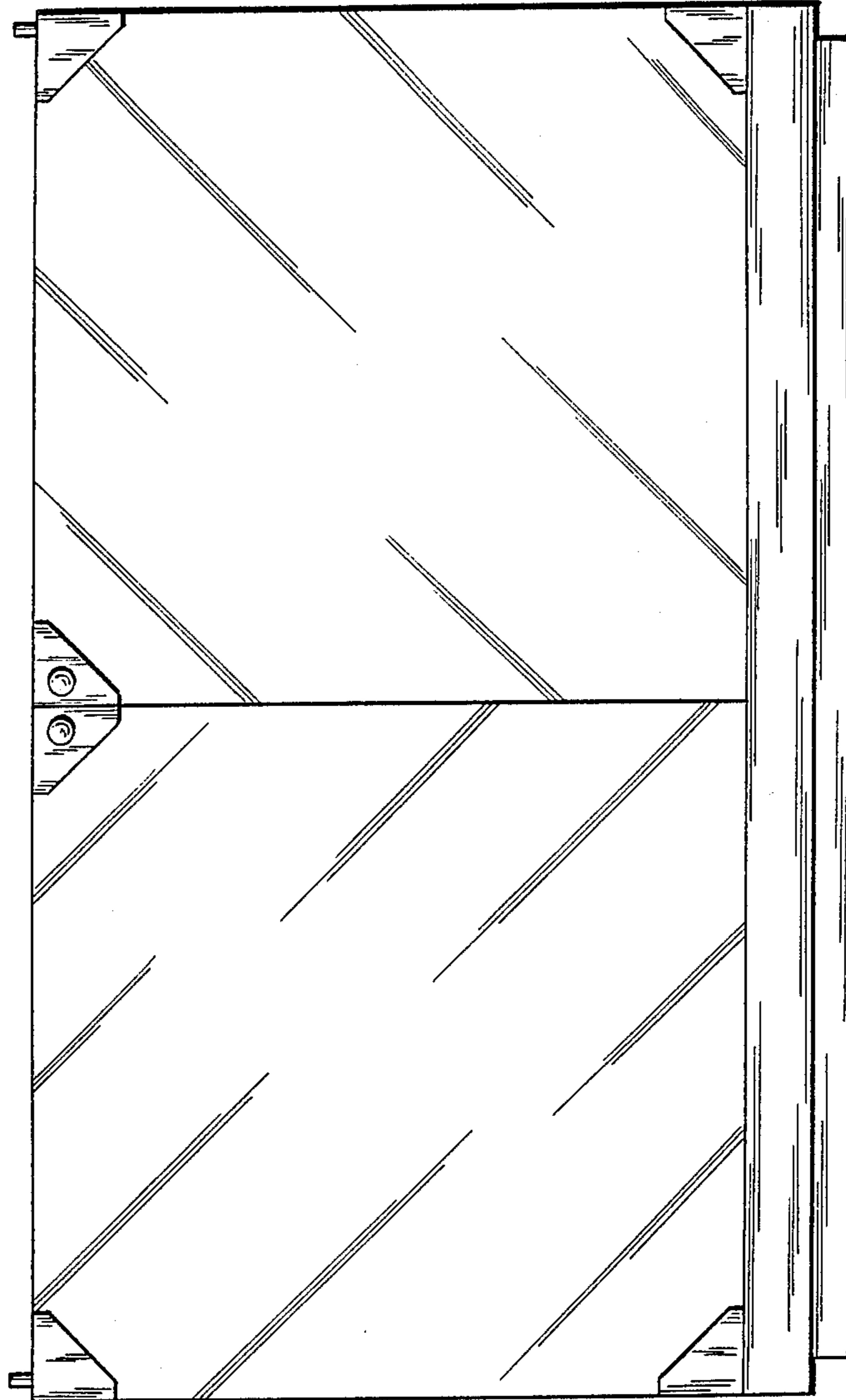

FIG. 6