

[54] CHIMNEY CAP COMPONENT

[76] Inventor: Leif A. Poulsen, 7803 Bremridge Drive, North Delta, British Columbia V4C 5E3, Canada

[**] Term: 14 Years

[21] Appl. No.: 190,230

[22] Filed: May 4, 1988

[52] U.S. Cl. D23/374; D25/118; D25/117

[58] Field of Search D23/373, 374; D25/114, D25/115, 117, 118; 52/596, 606, 609, 218, 219, 244; 98/67

[56] References Cited

U.S. PATENT DOCUMENTS

80,618	8/1868	Frailey	52/244
2,448,806	9/1948	Kepple	98/67
2,544,776	3/1951	Burger	D23/374
3,618,279	11/1971	Sease	D25/118
4,083,190	4/1978	Pey	D25/115

FOREIGN PATENT DOCUMENTS

270143	2/1913	Fed. Rep. of Germany	98/67
574944	of 1958	Italy	52/218
238811	8/1945	Switzerland	52/219

Primary Examiner—James M. Gandy
Assistant Examiner—Lisa Lichtenstein
Attorney, Agent, or Firm—Fetherstonhaugh & Co.

[57] CLAIM

The ornamental design for a chimney cap component, as shown and described.

DESCRIPTION

FIG. 1 is a front perspective view of a chimney cap component showing my new design;
 FIG. 2 is a top plan view thereof;
 FIG. 3 is a right side elevational view thereof;
 FIG. 4 is a left side elevational view thereof;
 FIG. 5 is a front elevational view thereof;
 FIG. 6 is a rear elevational view thereof;
 FIG. 7 is a bottom plan view thereof;
 FIG. 8 is a front perspective view of a chimney cap component, showing a second embodiment of my new design;
 FIG. 9 is a top plan view of FIG. 8;
 FIG. 10 is a right side elevational view of FIG. 8;
 FIG. 11 is a left side elevational view of FIG. 8;
 FIG. 12 is a front elevational view of FIG. 8;
 FIG. 13 is a rear elevational view of FIG. 8;
 FIG. 14 is a bottom plan view of FIG. 8;
 FIG. 15 is a front perspective view of a chimney cap component, showing a third embodiment of my new design;
 FIG. 16 is a top plan view of FIG. 15;
 FIG. 17 is a right side elevational view of FIG. 15;
 FIG. 18 is a left side elevational view of FIG. 15;
 FIG. 19 is a front elevational view of FIG. 15;
 FIG. 20 is a rear elevational view of FIG. 15; and
 FIG. 21 is a bottom plan view of FIG. 15.

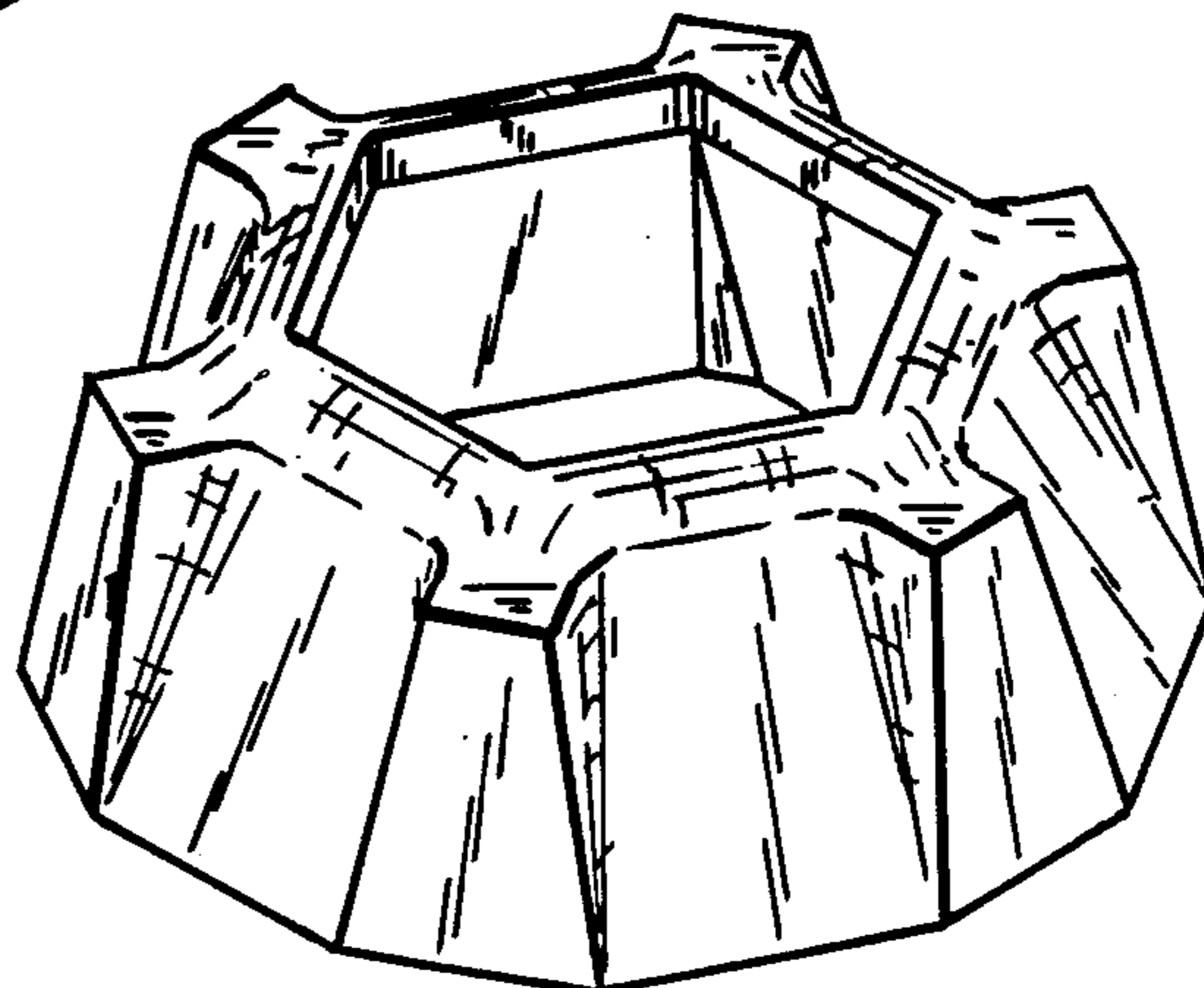
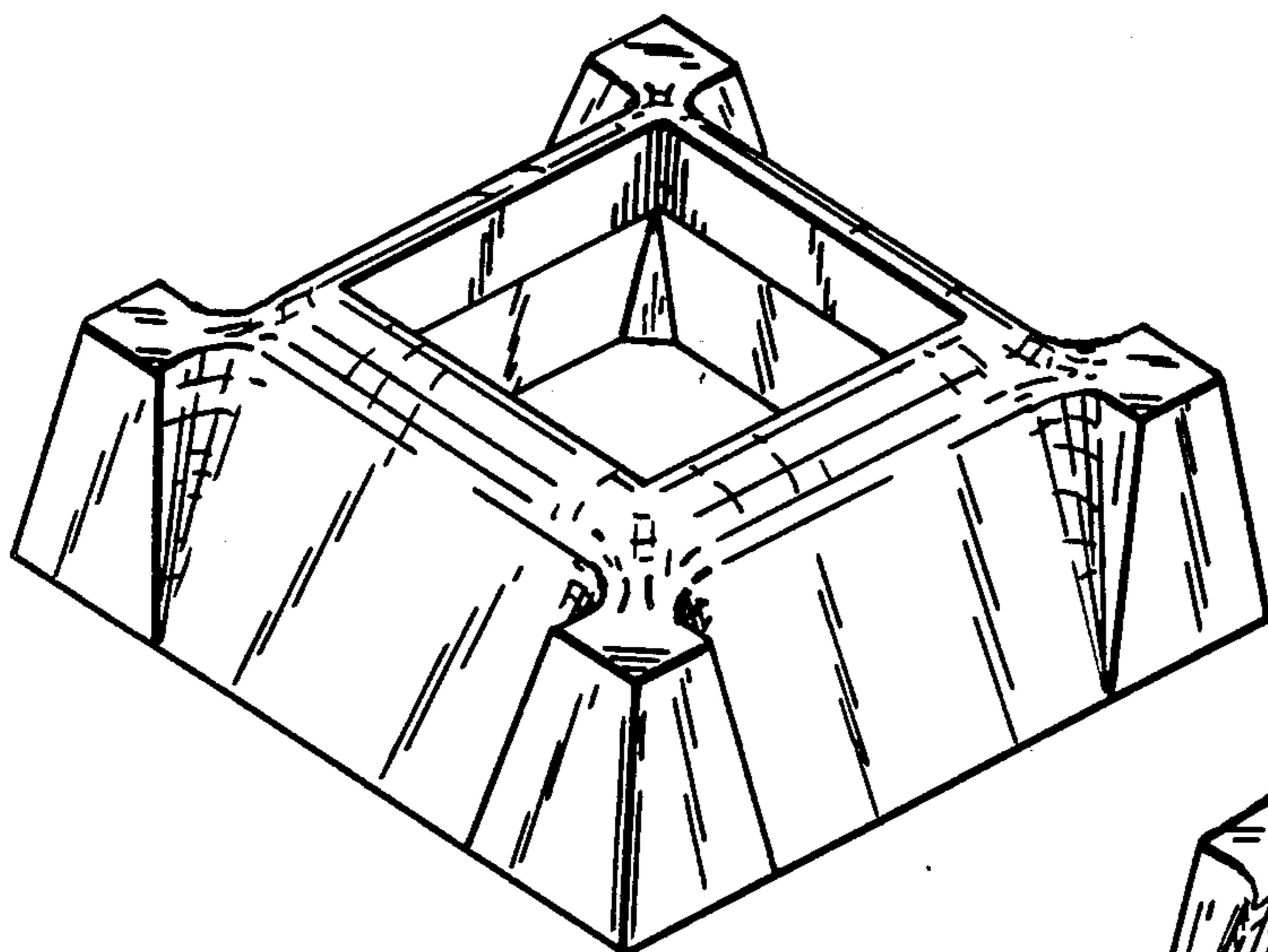

Fig. 1.

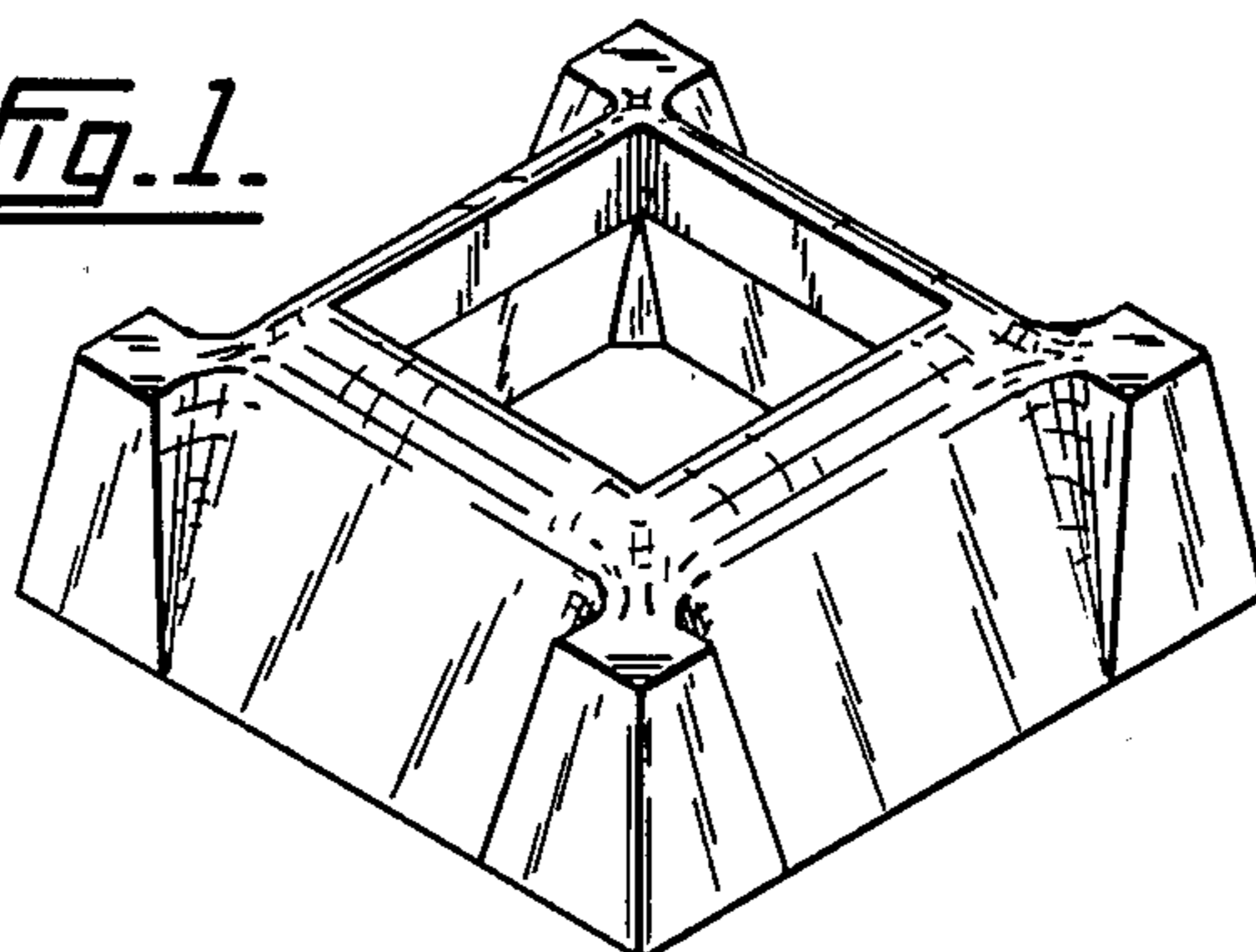

Fig. 3.

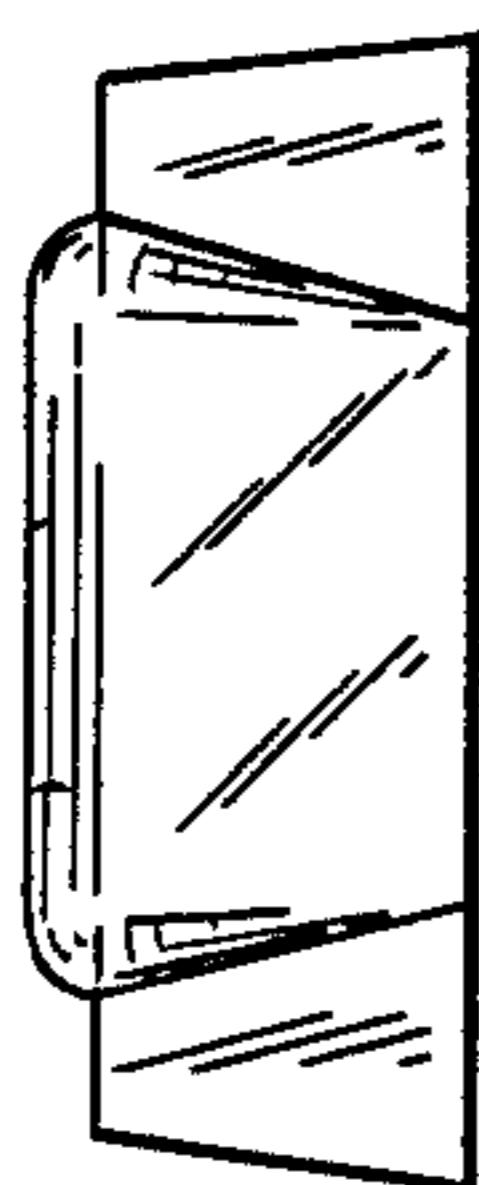

Fig. 2.

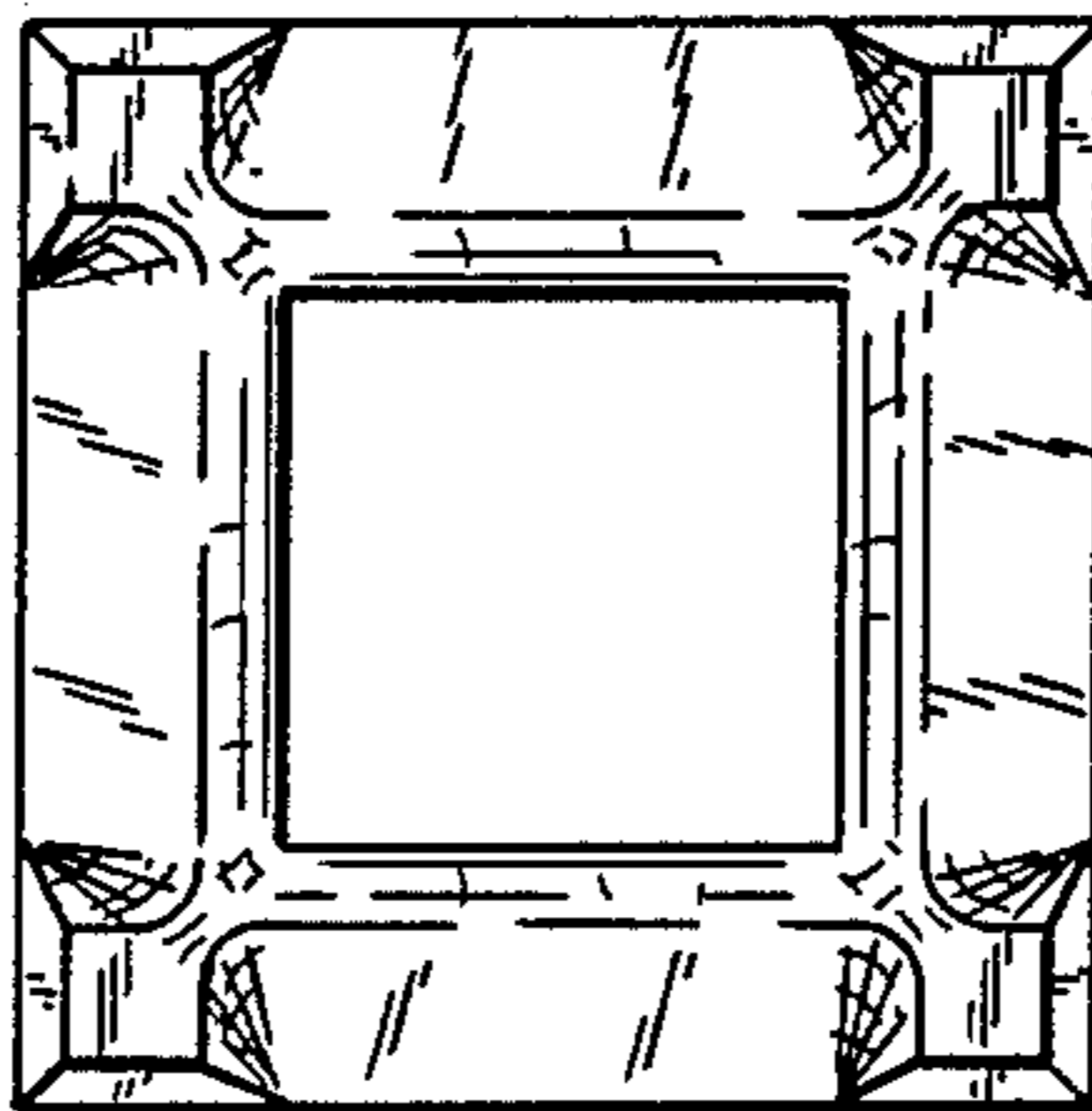

Fig. 4.



Fig. 5.

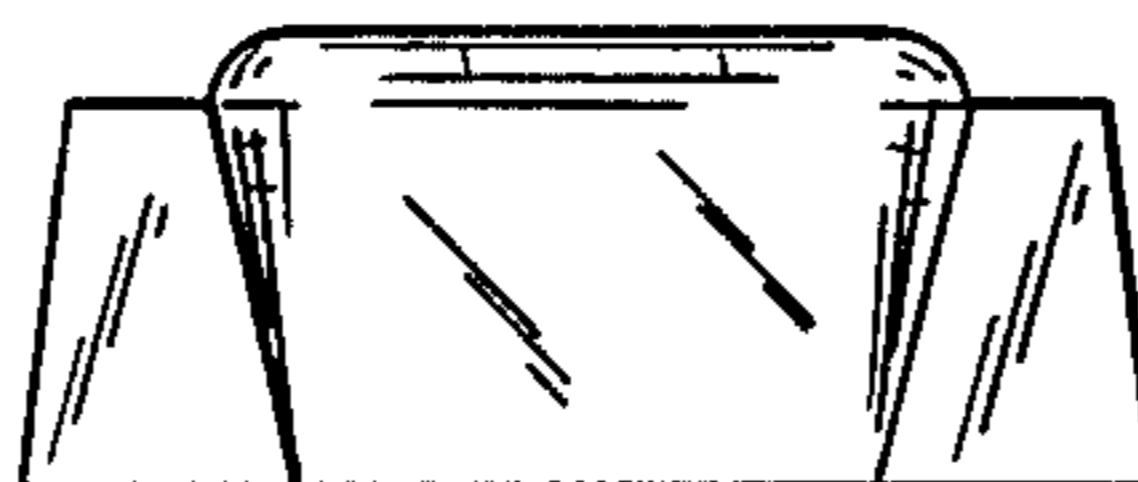

Fig. 6.

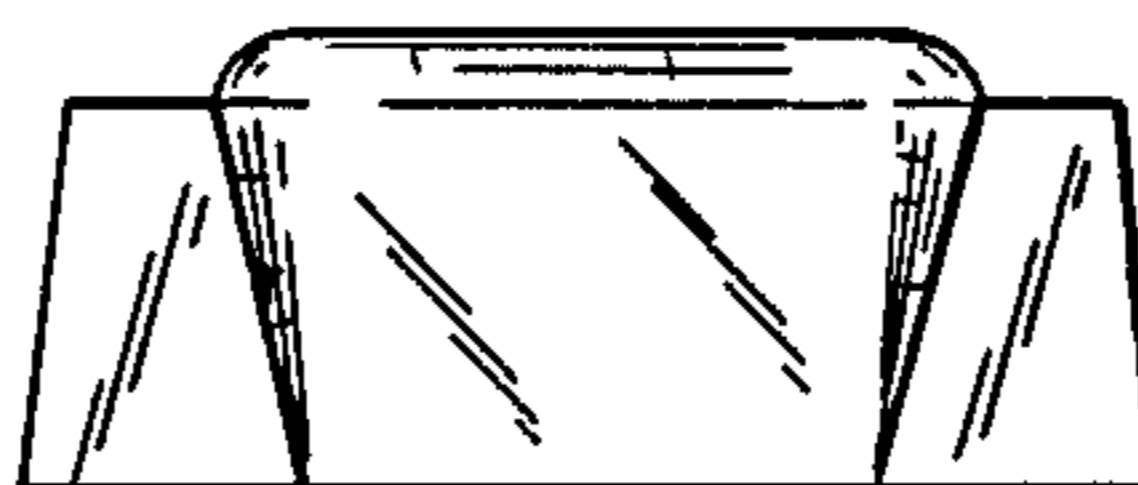

Fig. 7.

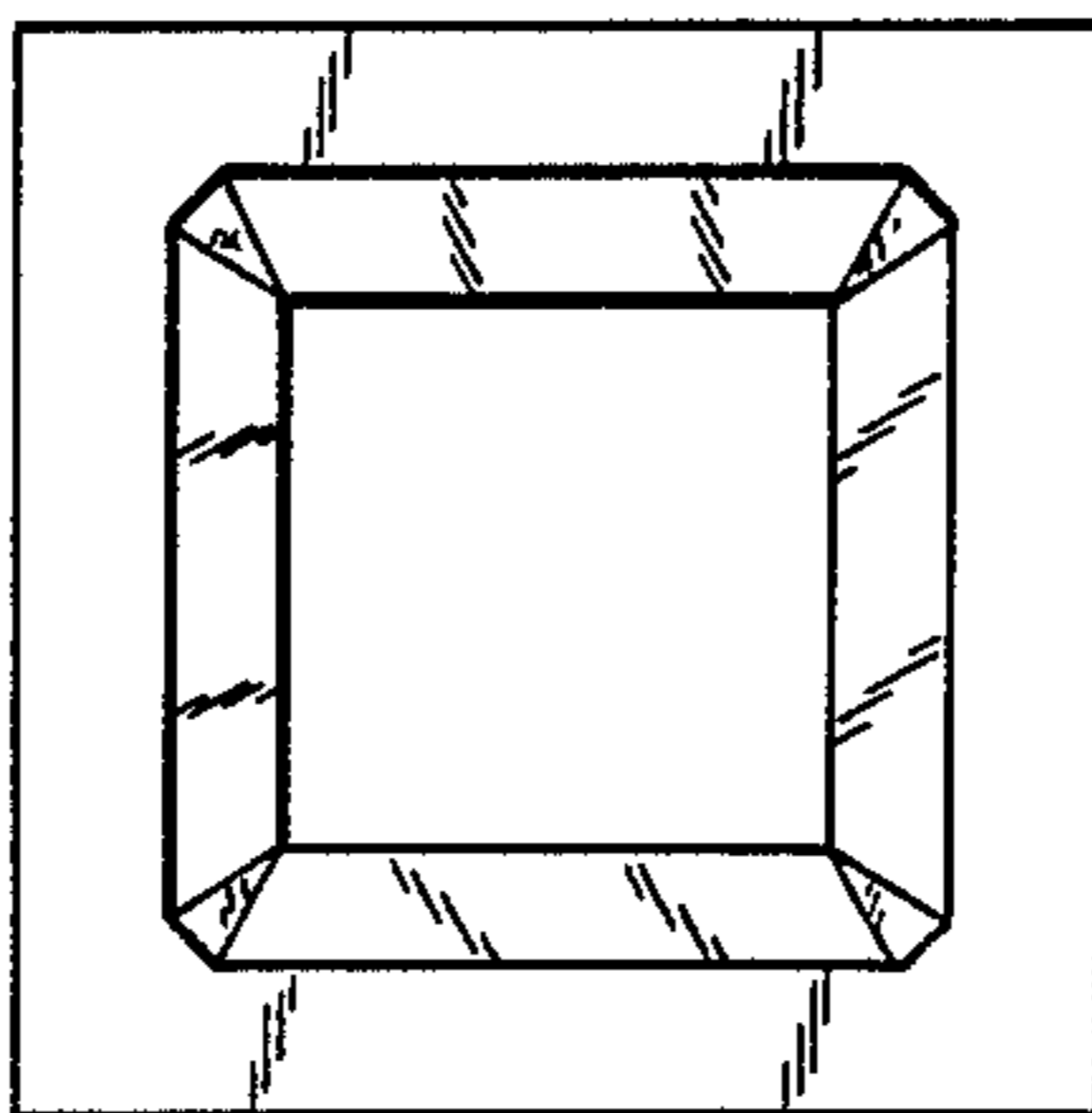

Fig. 8.

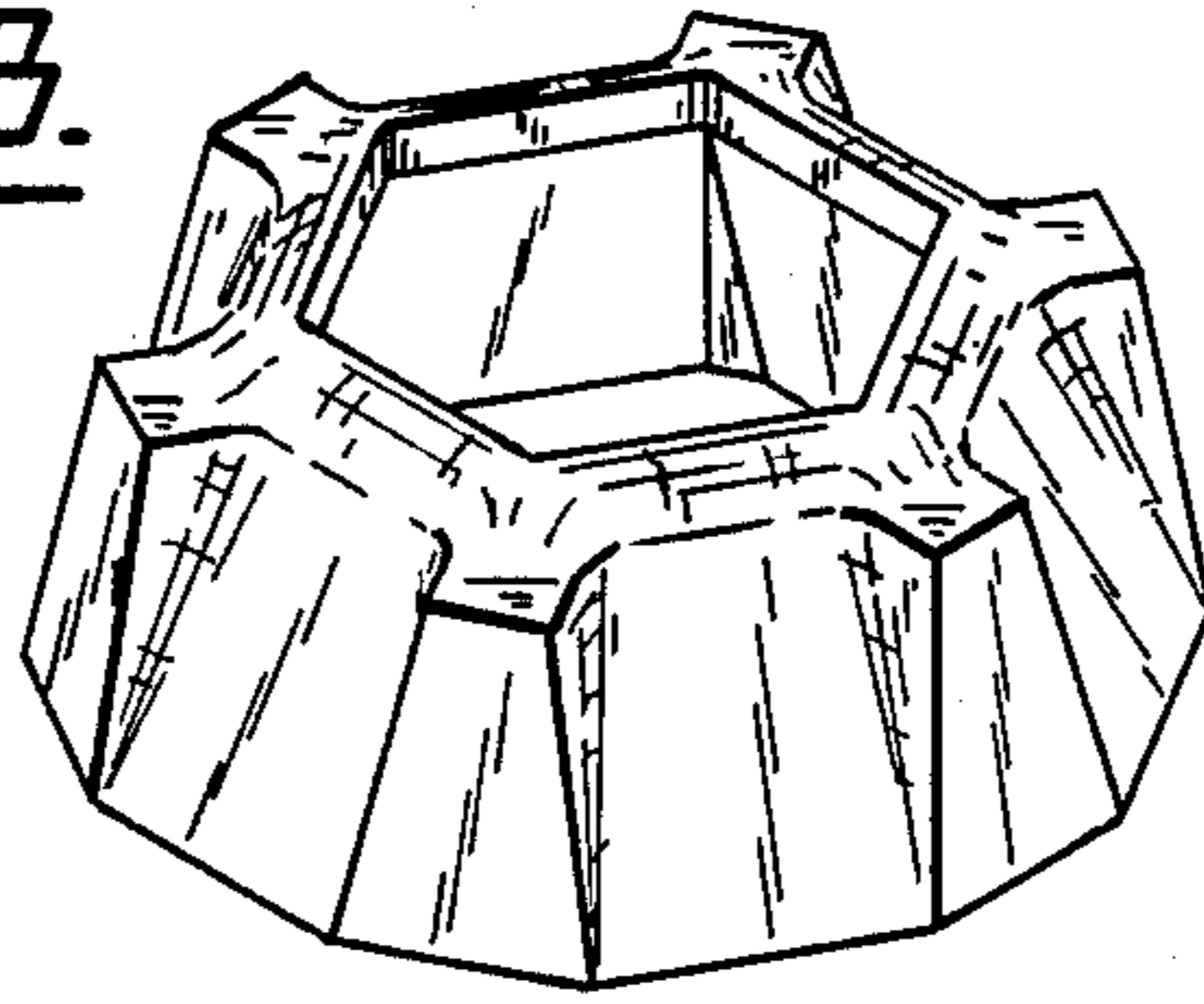

Fig. 10.

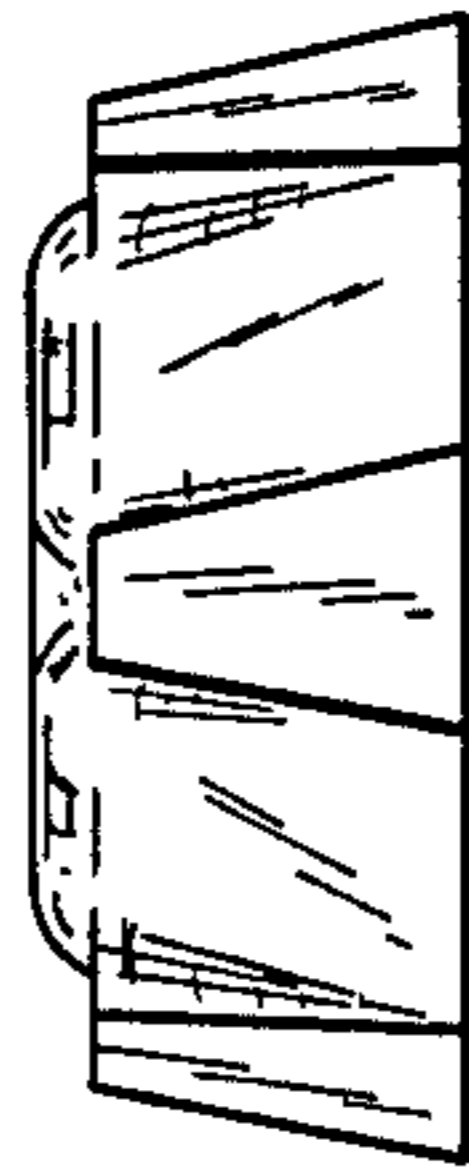

Fig. 9.

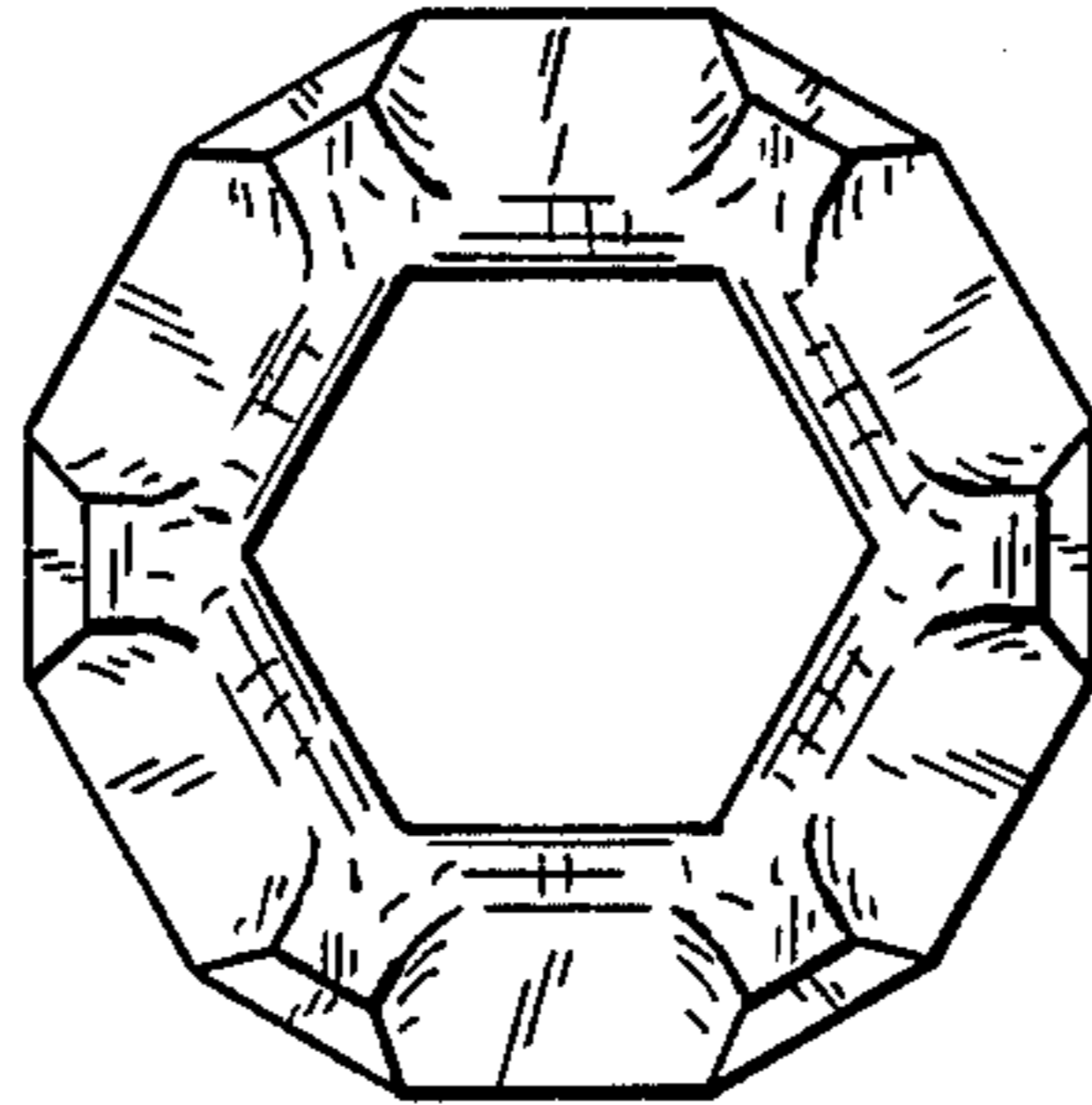

Fig. 11.

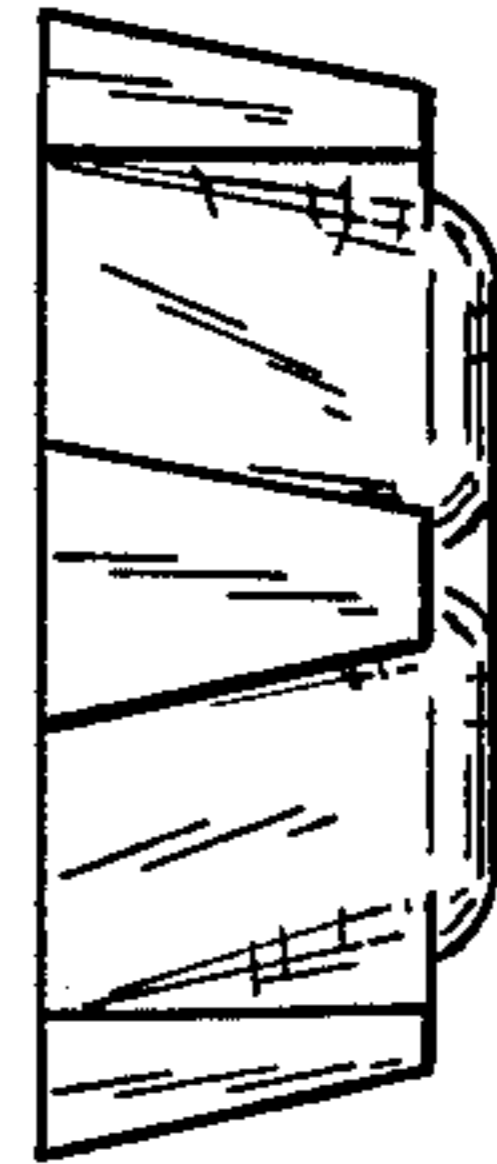

Fig. 12.

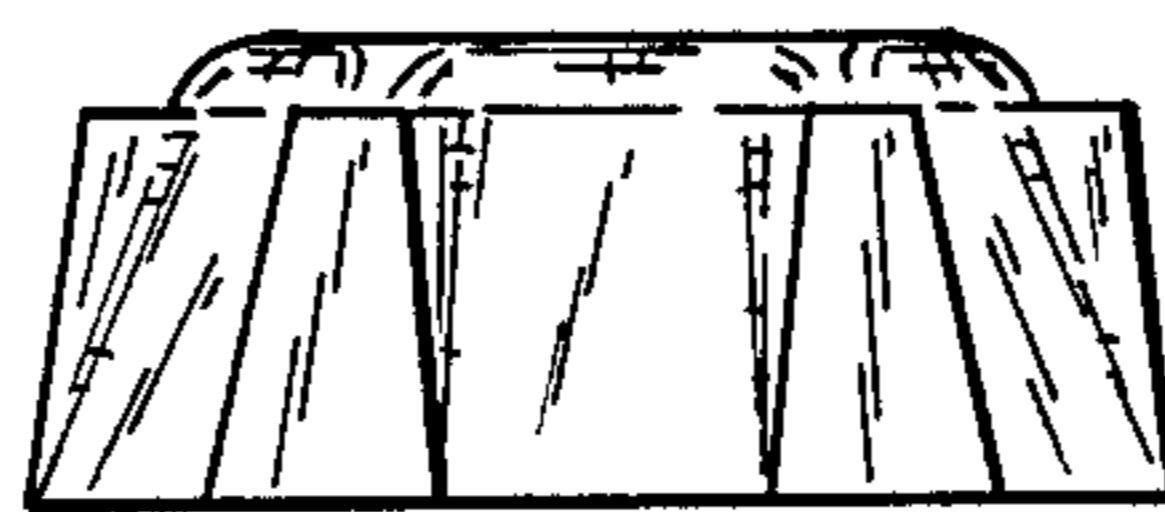

Fig. 13.

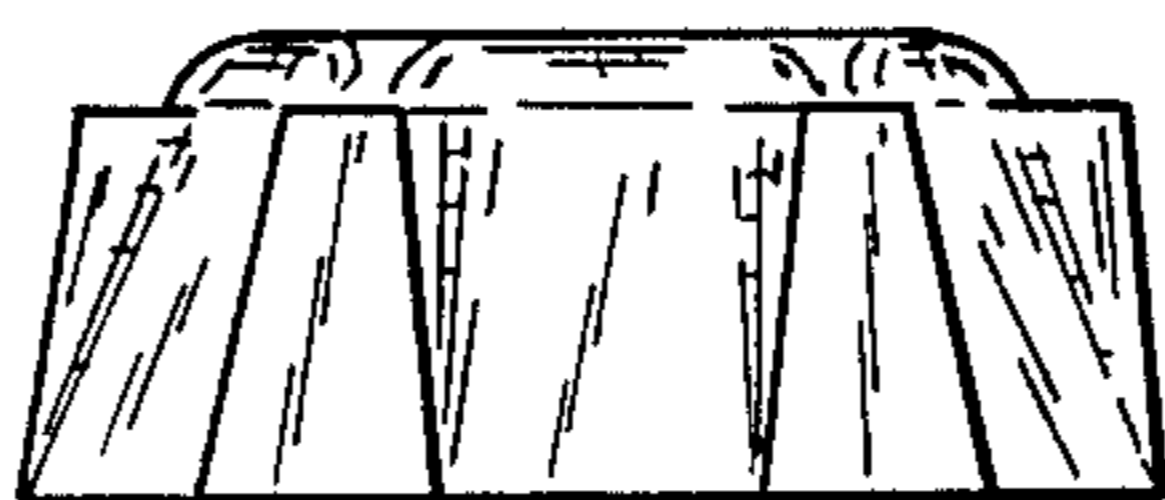

Fig. 14.

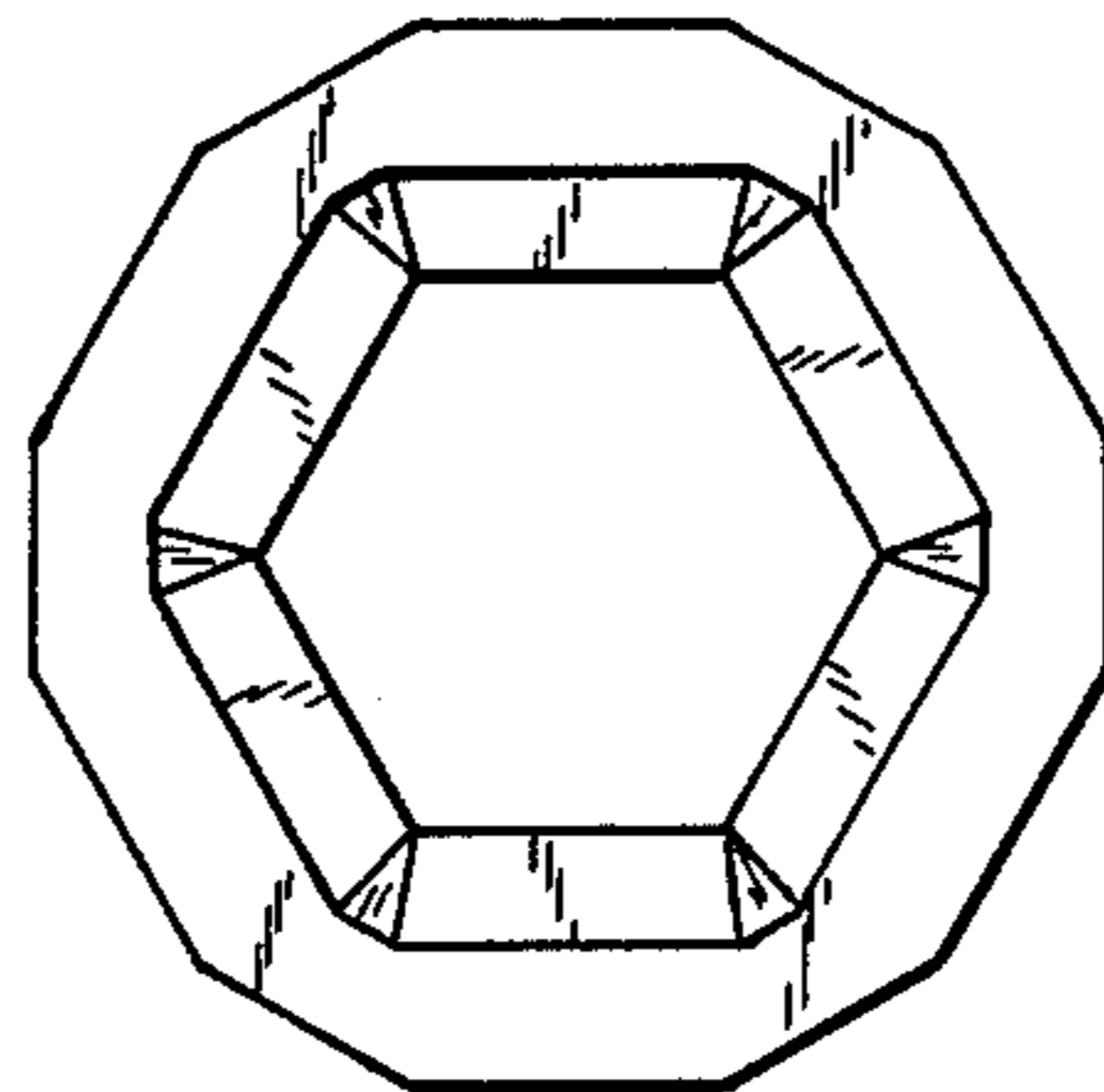

Fig. 15.

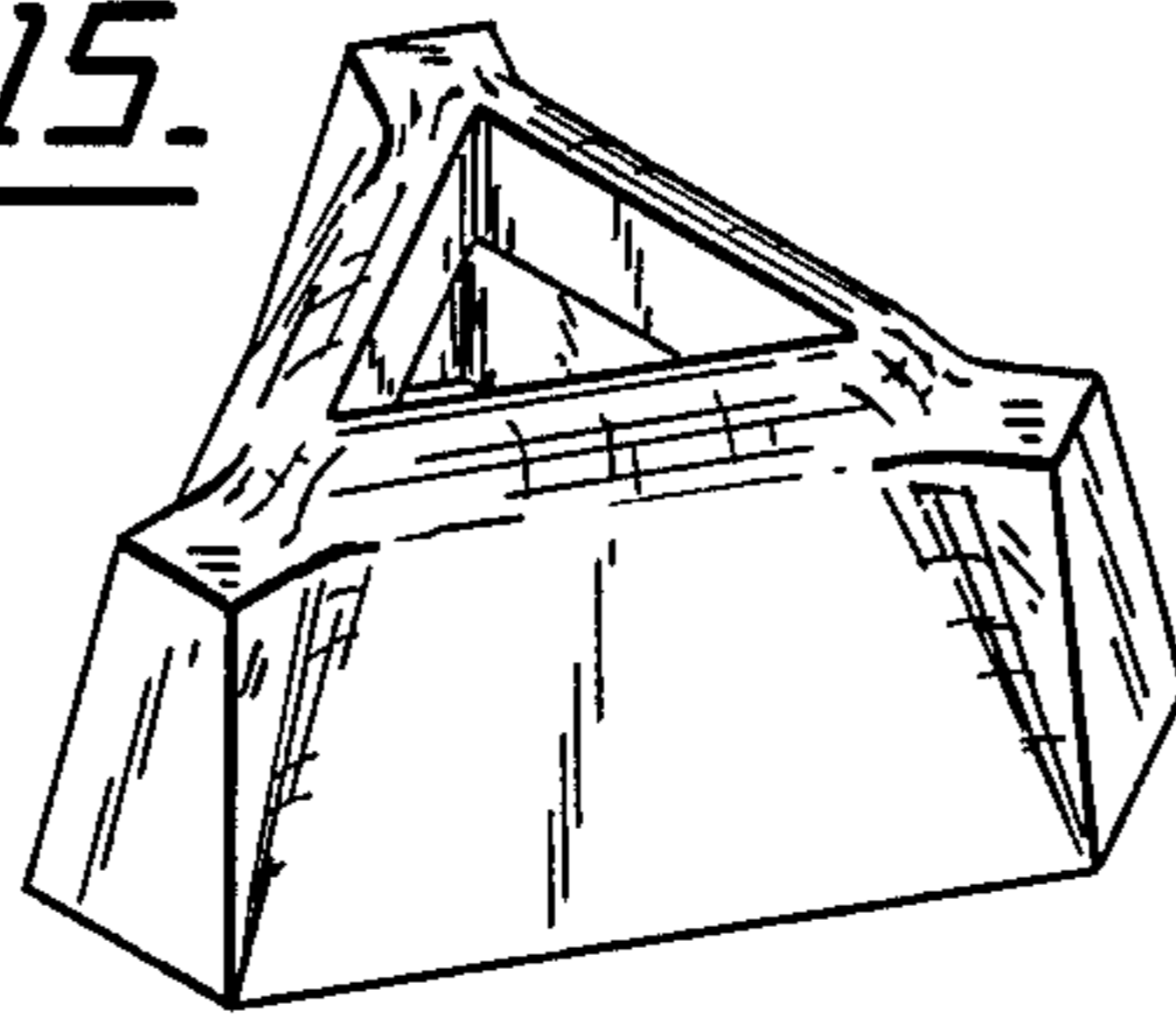

Fig. 17.

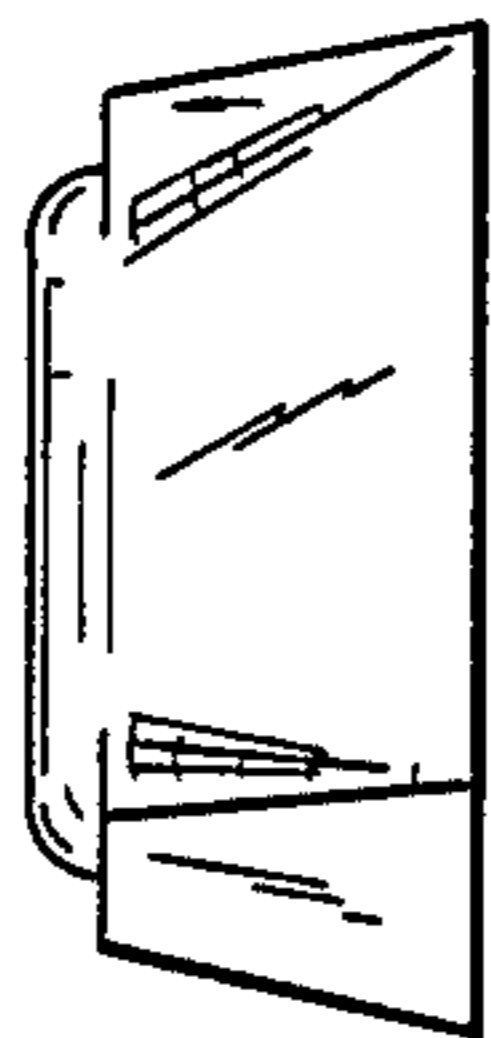

Fig. 16.

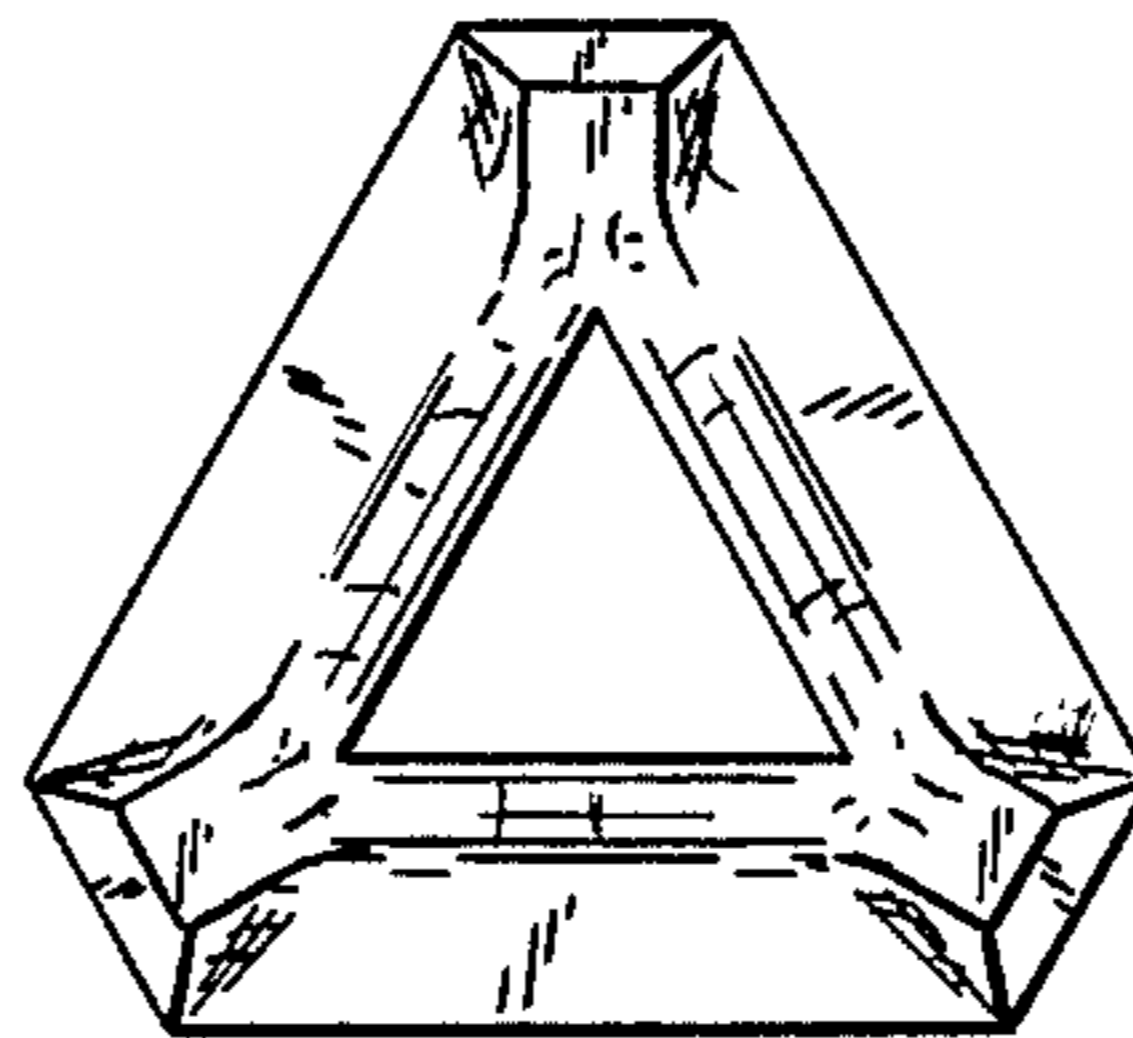

Fig. 18.

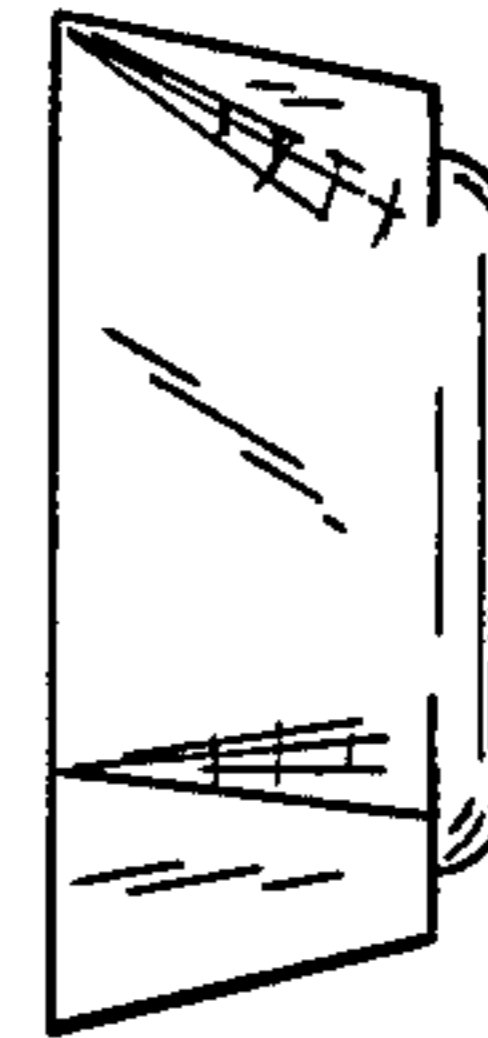

Fig. 19.

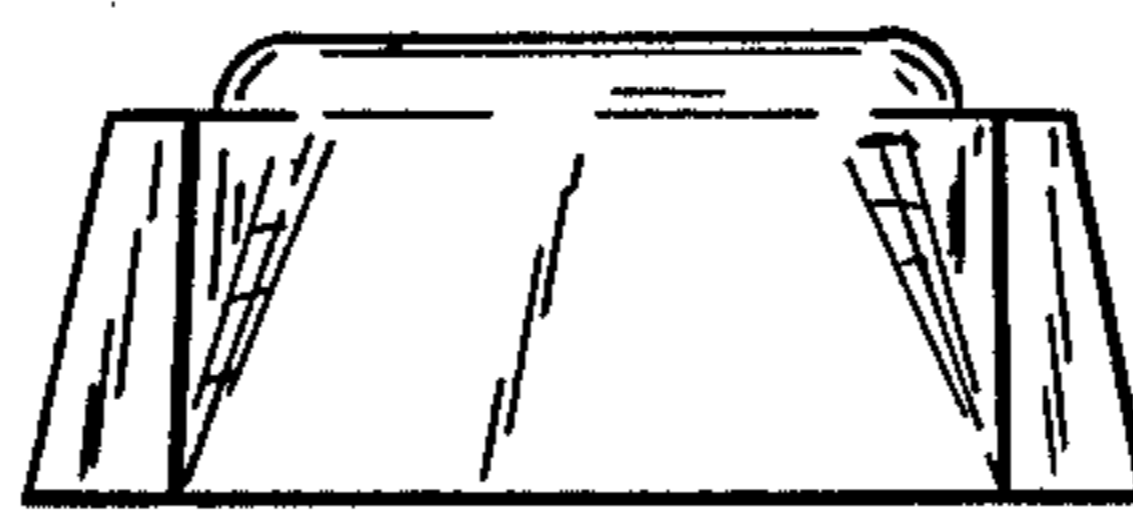

Fig. 20.

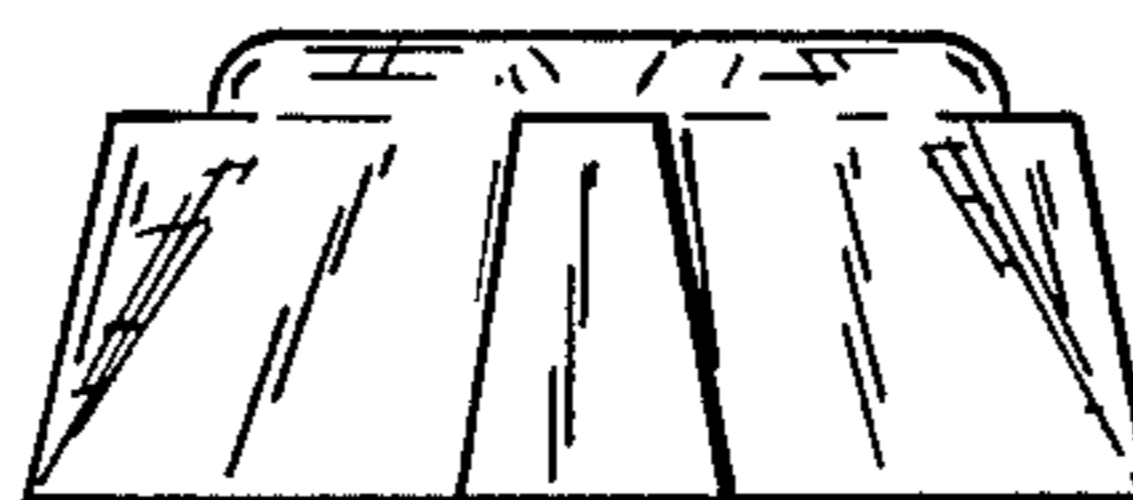

Fig. 21.

