

[54] PRINTER

[75] Inventor: Tatsuo Kojima, Yokohama, Japan

[73] Assignee: Canon Kabushiki Kaisha, Tokyo, Japan

[**] Term: 14 Years

[21] Appl. No.: 29,875

[22] Filed: Mar. 25, 1987

[30] Foreign Application Priority Data

Oct. 2, 1986 [JP] Japan 61-39204
[52] U.S. Cl. D18/13
[58] Field of Search D14/111; D18/13, 22, D18/23, 36, 42; 400/613.2-613.4, 691-694

[56] References Cited

U.S. PATENT DOCUMENTS

- D. 250,144 10/1978 Coppola D18/13
D. 269,274 6/1983 Hofland et al. D18/13
D. 276,051 10/1984 Kosako et al. D18/36
D. 280,723 9/1985 Nishida et al. D14/111
D. 283,900 5/1986 Hollerith, Jr. et al. D18/13
D. 284,006 5/1986 Freijd D18/13
D. 287,730 1/1987 Kojima et al. D14/111
D. 291,095 7/1987 Morozumi et al. D18/13
D. 295,856 5/1988 Hara D18/13
D. 296,906 7/1988 Burrows D18/13

FOREIGN PATENT DOCUMENTS

658401 8/1985 Japan .

658402 8/1985 Japan .
694446 12/1986 Japan .
694744 12/1986 Japan .

OTHER PUBLICATIONS

Digital's LN03 Laser Printer; ©1985; found in art unit 290.
Canon LBP-8II Laser Beam Printer; 1987; found in art unit 290.
Genicom 5010; 6/86; found in art unit 290.

Primary Examiner—James R. Largen
Assistant Examiner—Cathy Anne MacCormac
Attorney, Agent, or Firm—Fitzpatrick, Cella, Harper & Scinto

[57] CLAIM

The ornamental design for printer, as shown and described.

DESCRIPTION

FIG. 1 is a front elevational view of a printer showing my new design;
FIG. 2 is a rear elevational view thereof;
FIG. 3 is a top plan view thereof;
FIG. 4 is a bottom plan view thereof;
FIG. 5 is a left side elevational view thereof;
FIG. 6 is a right side elevational view thereof;
FIG. 7 is a top front and left side perspective view thereof. The broken lines representation of two paper trays is for illustrative purposes only and forms no part of the claimed design.

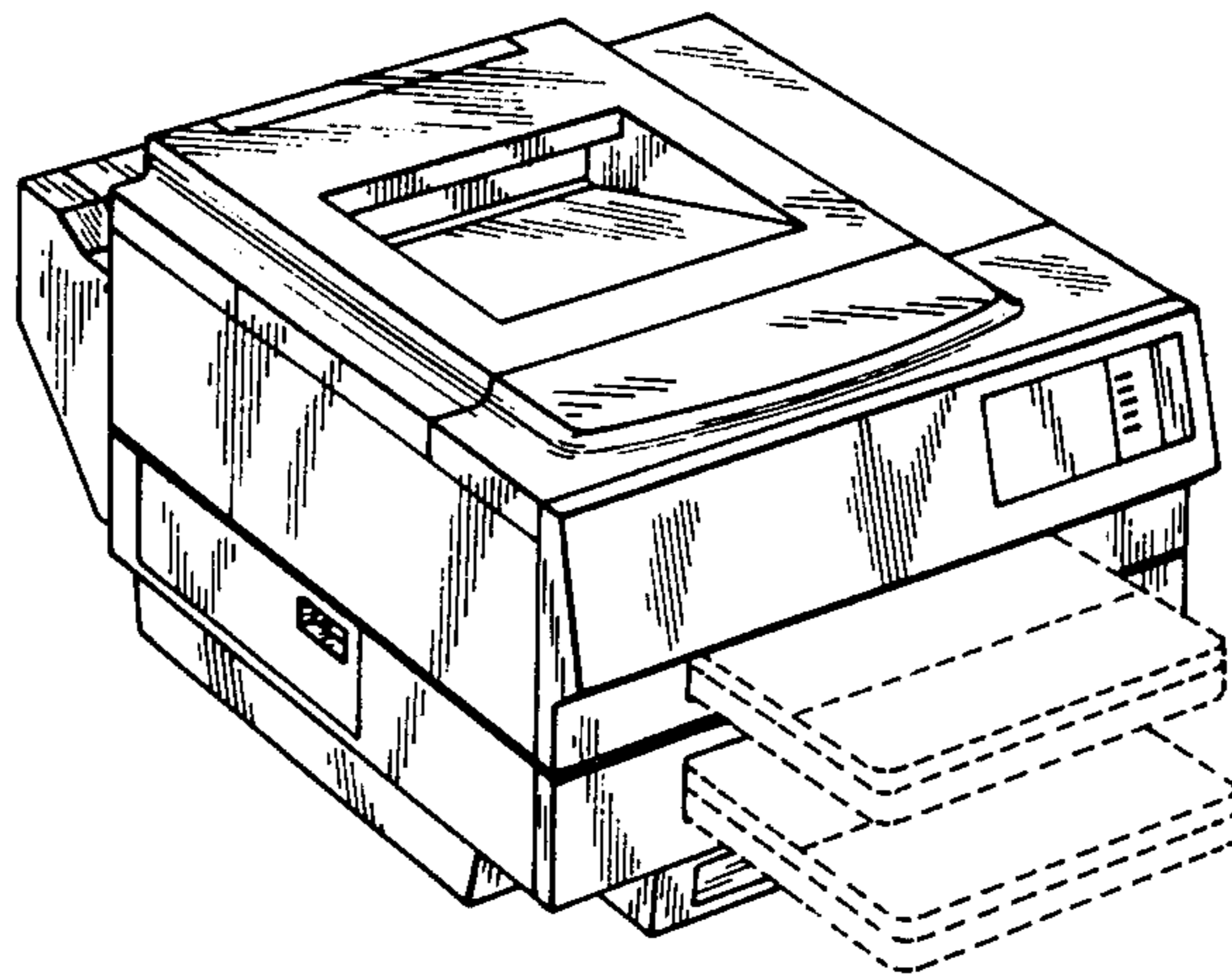

FIG. 1

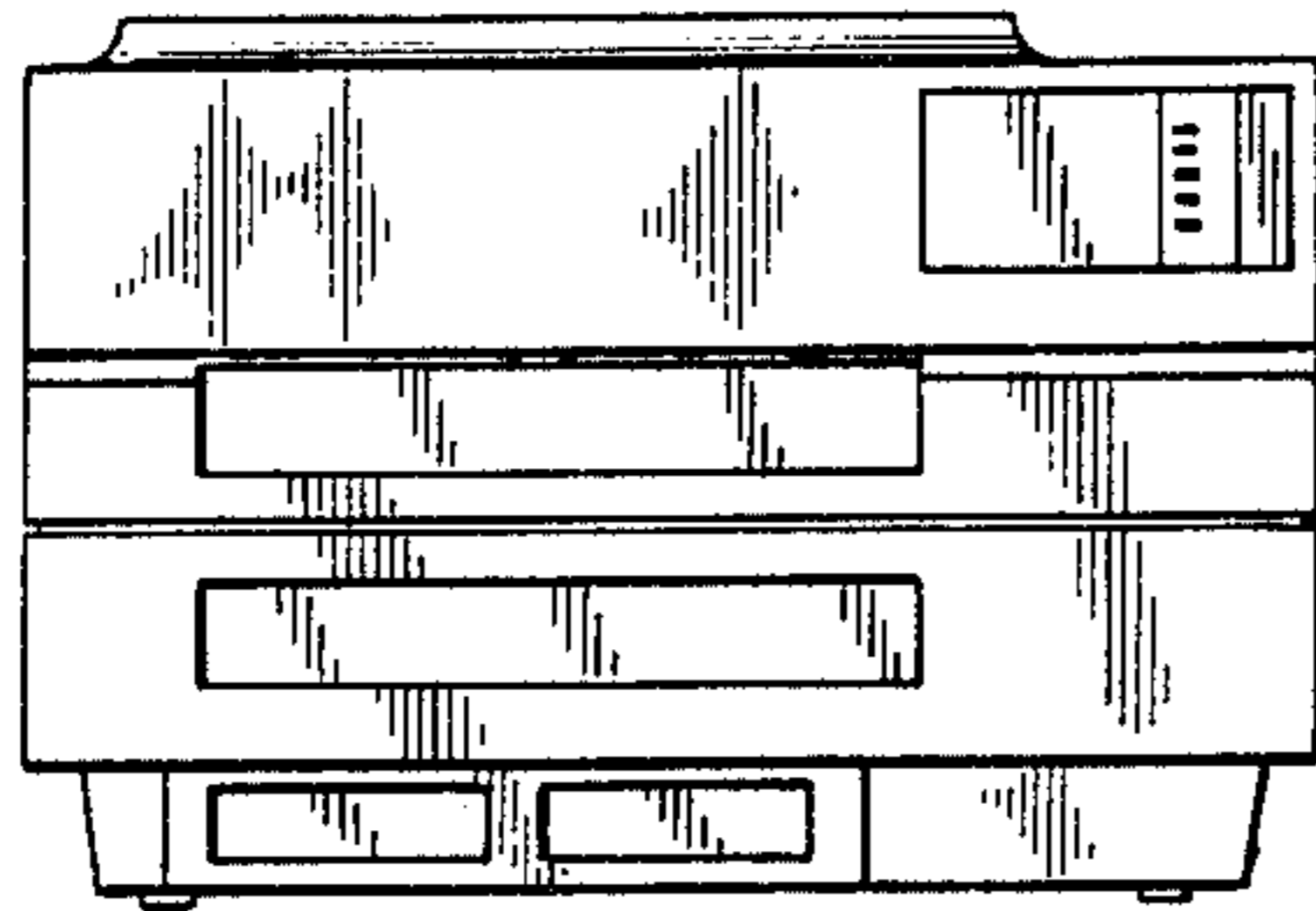

FIG. 2

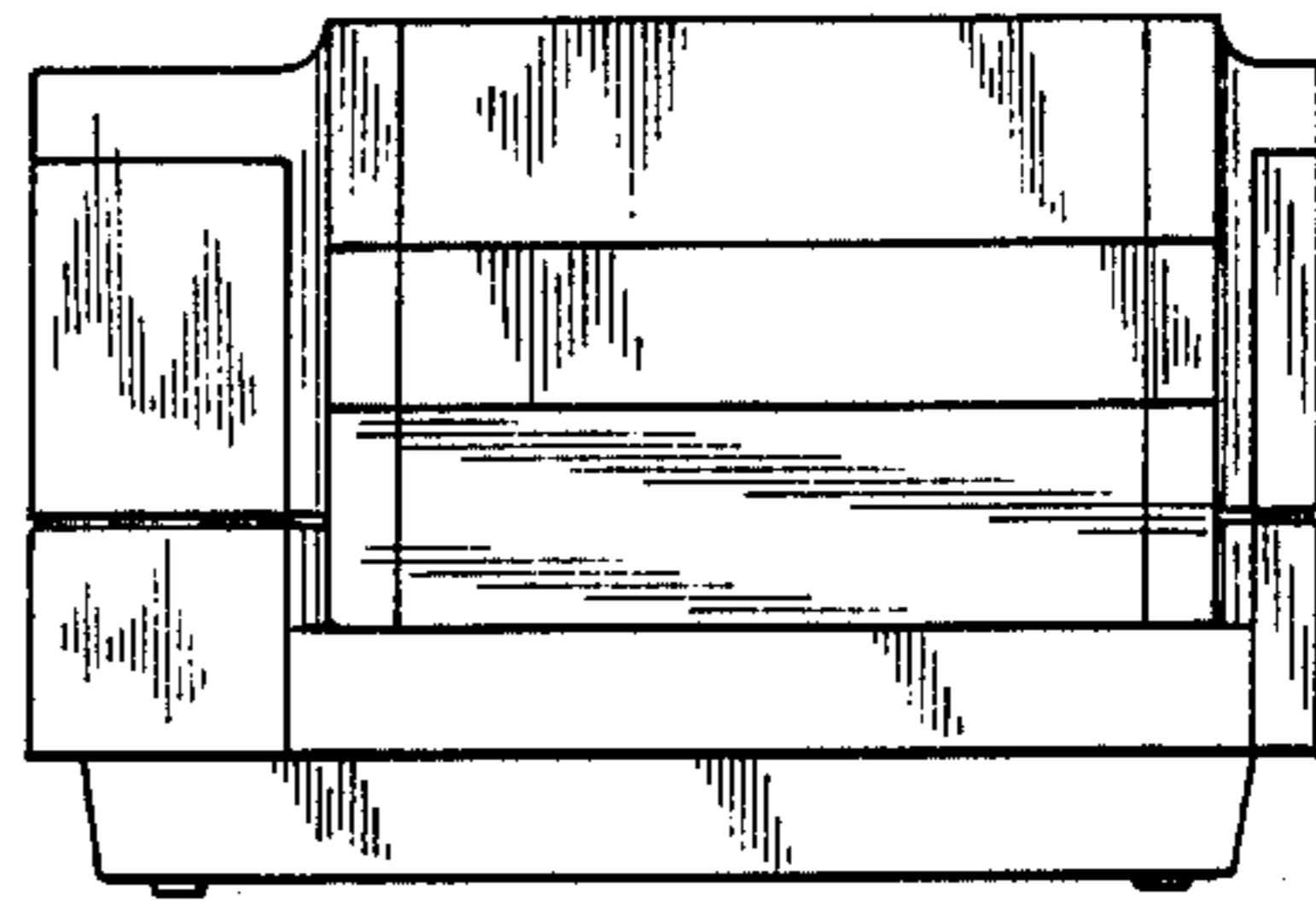

FIG. 3

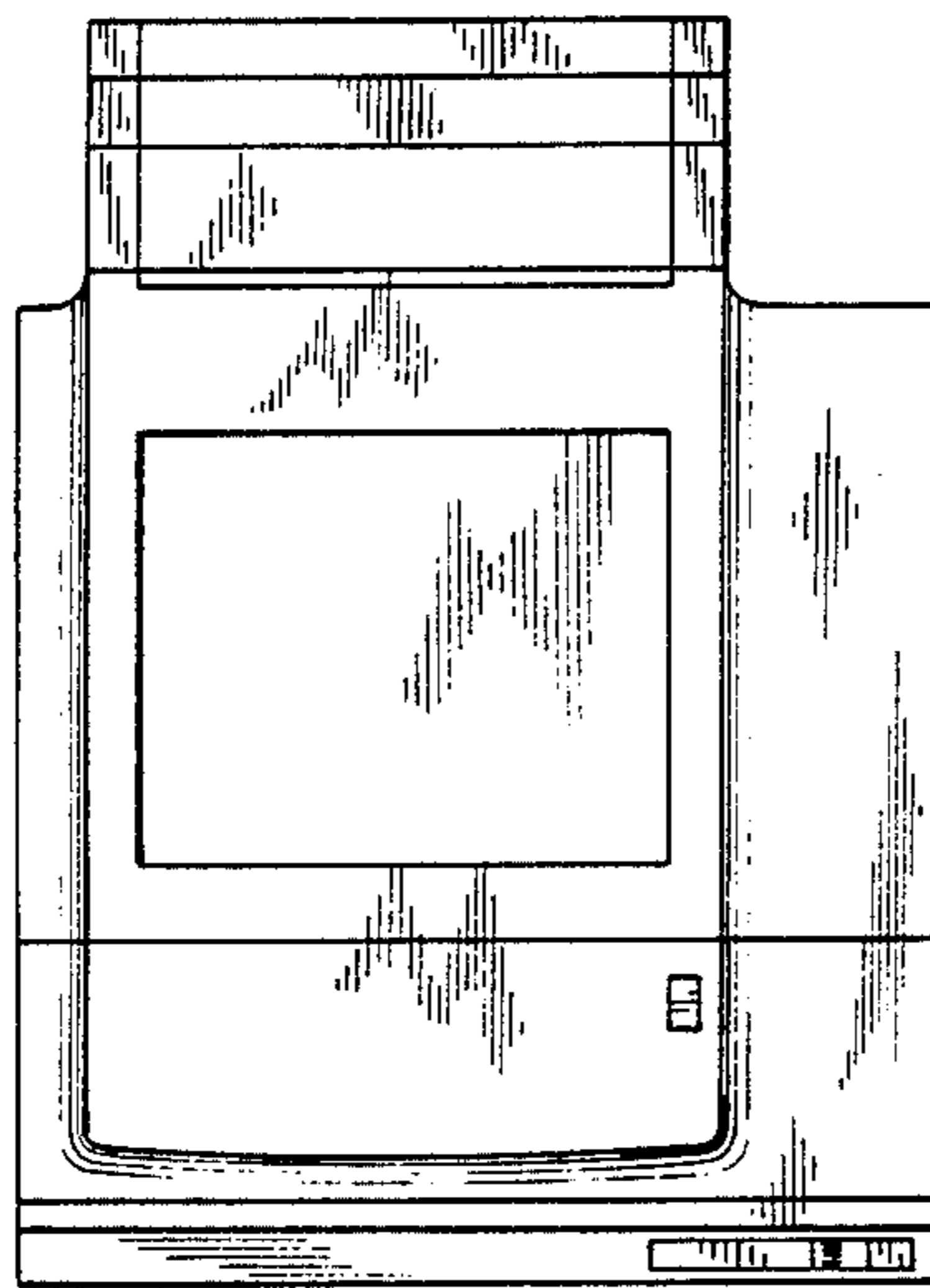

FIG. 4

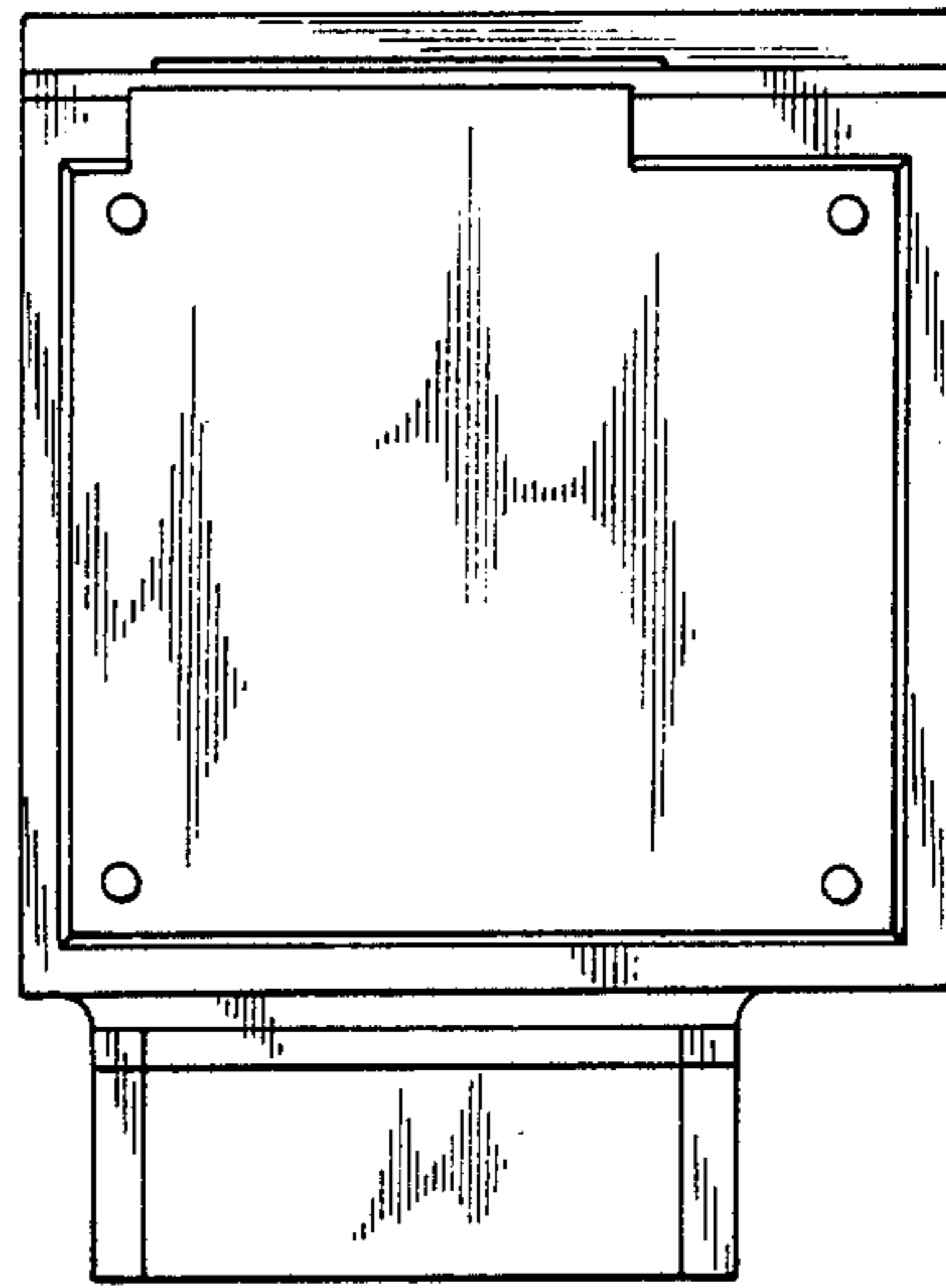

FIG. 5

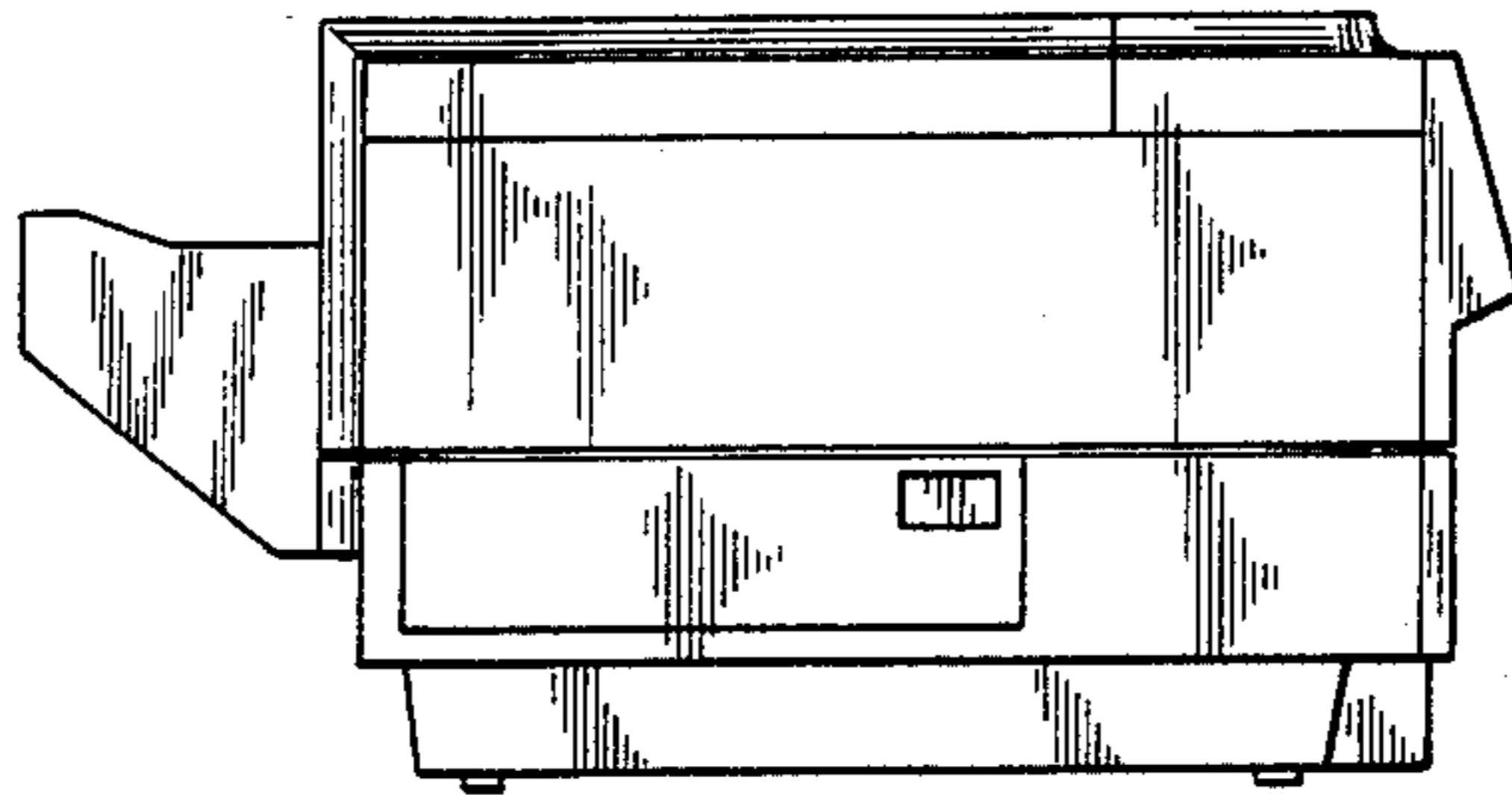

FIG. 6

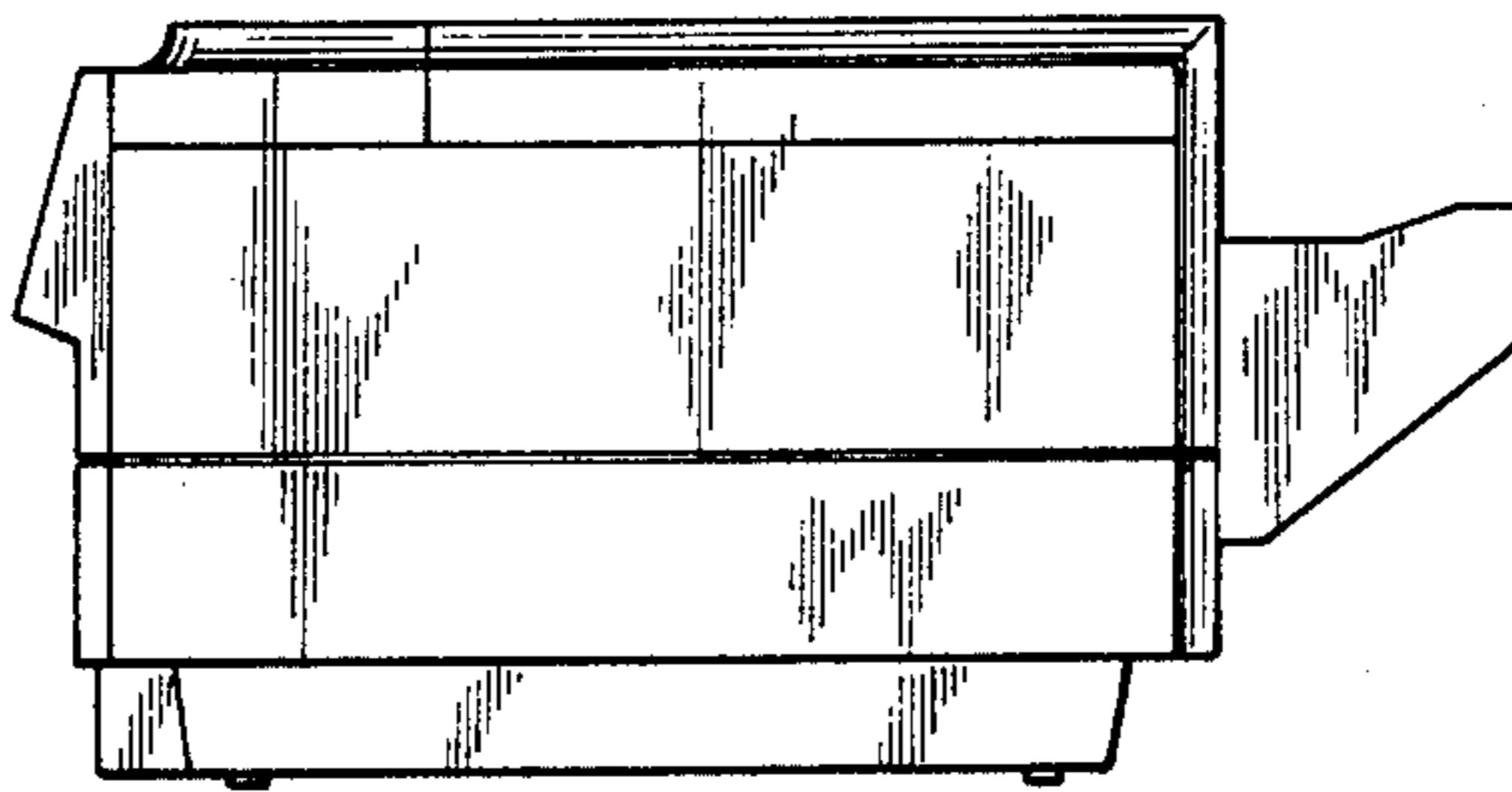

FIG. 7

