

[54] HOUSING FOR A WALL MOUNTED KEYBOARD INSTRUMENT WITH HORIZONTALLY SPACED SPEAKER UNITS

[76] Inventor: Le Roi J. Ryan, P.O. Box 11404, Chicago, Ill. 60611

[**] Term: 14 Years

[21] Appl. No.: 93,869

[22] Filed: Sep. 8, 1987

[52] U.S. Cl. D17/6; D17/1; D17/5

[58] Field of Search D17/1, 2, 5, 6, 7, 8, D17/9; 84/172, 176, 177, 178, 179, 180, DIG. 17, DIG. 25

[56] References Cited U.S. PATENT DOCUMENTS

- D. 207,126 3/1967 Palma, Jr. D17/6
- D. 207,347 4/1967 Ryan, Jr. D17/6
- D. 207,975 6/1967 Ryan, Jr. D17/6
- D. 219,401 12/1970 White, Jr. D17/6

Primary Examiner—Bernard Ansher

Assistant Examiner—Adir Aronovich
Attorney, Agent, or Firm—Lloyd L. Zickert

[57] CLAIM

The ornamental design of a housing for a wall mounted keyboard instrument with horizontally spaced speaker units, as shown and described.

DESCRIPTION

FIG. 1 is a front perspective view of a housing for a wall mounted keyboard instrument with horizontally spaced speaker units showing my new design; FIG. 2 is a left side elevational view, the right side elevational view being substantially a mirror image of the side shown; FIG. 3 is a front elevational view thereof; FIG. 4 is a top plan view thereof; FIG. 5 is a rear elevational view thereof; FIG. 6 is a bottom plan view thereof; and FIG. 7 is a front perspective view thereof with vertically spaced speaker units. The broken-line showing of keys, control buttons and pedals is for illustrative purposes only and forms no part of the claimed design.

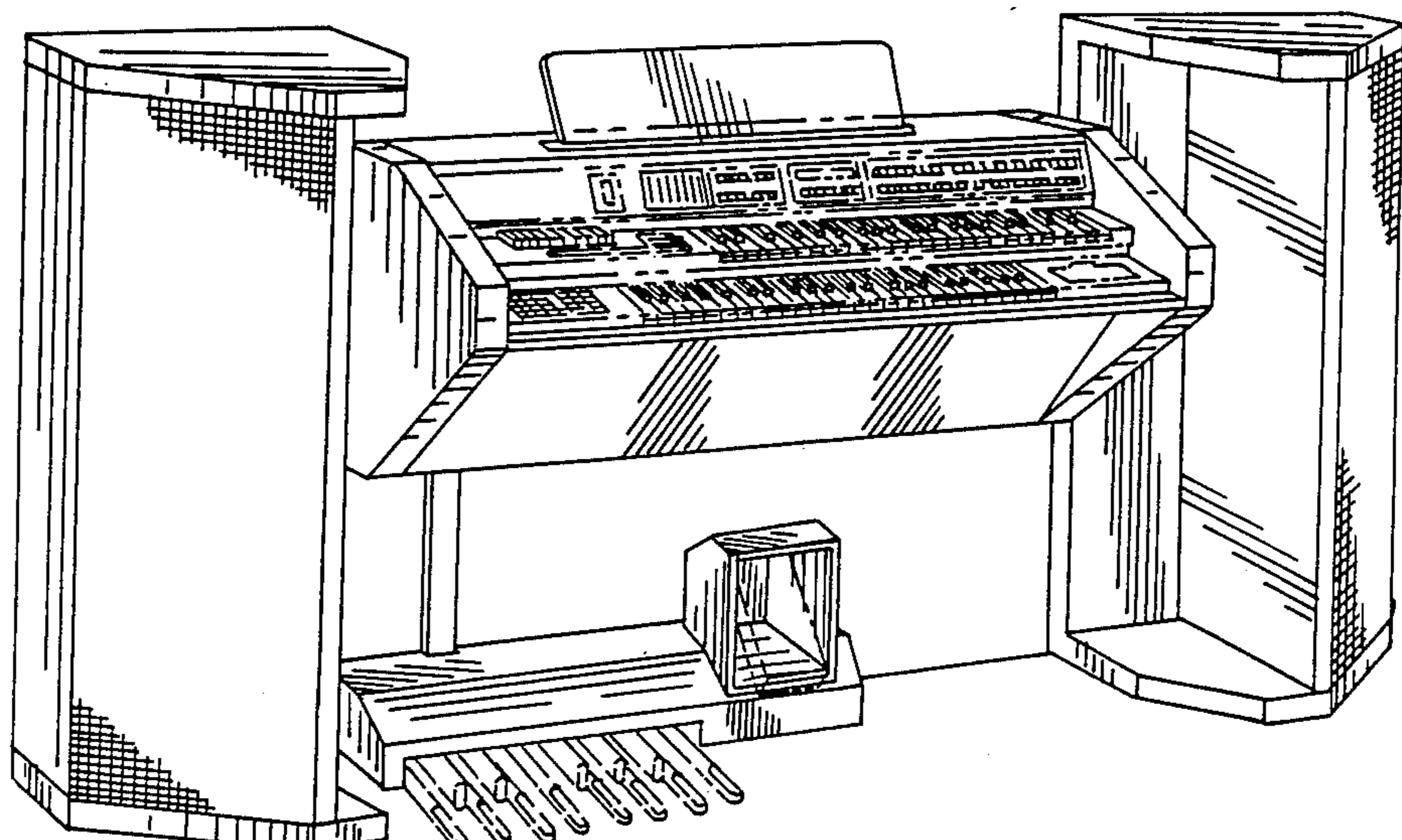
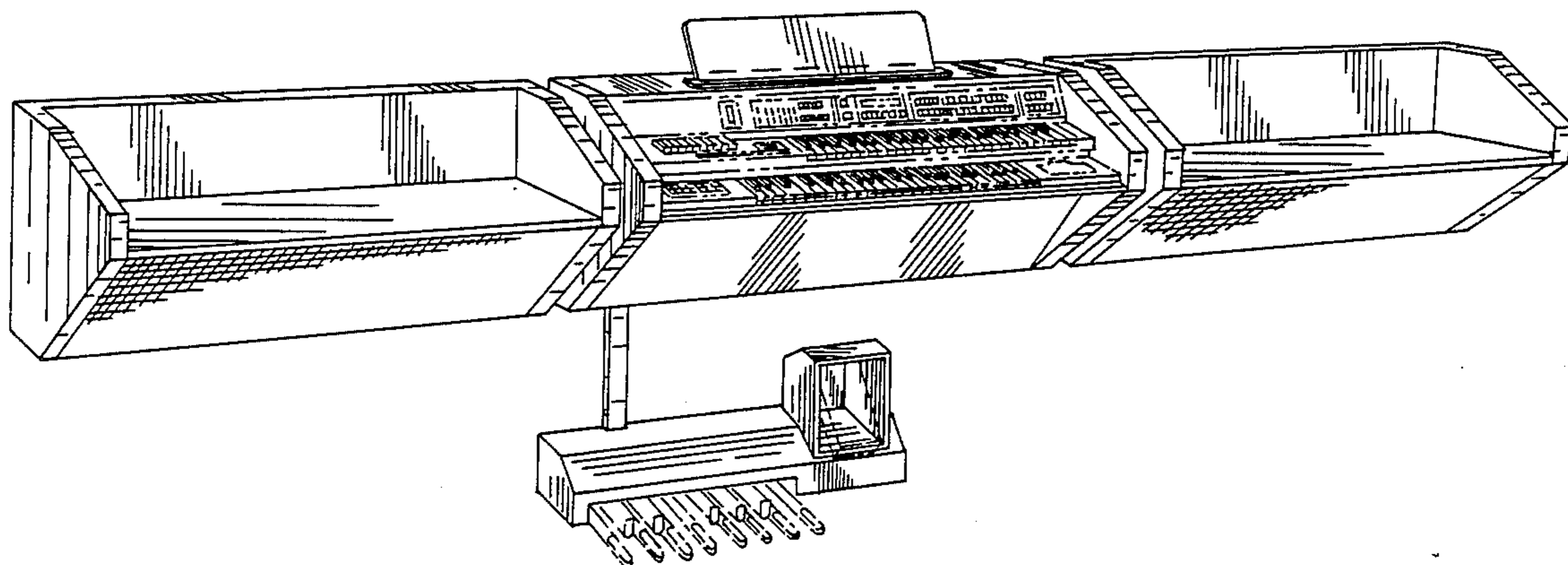

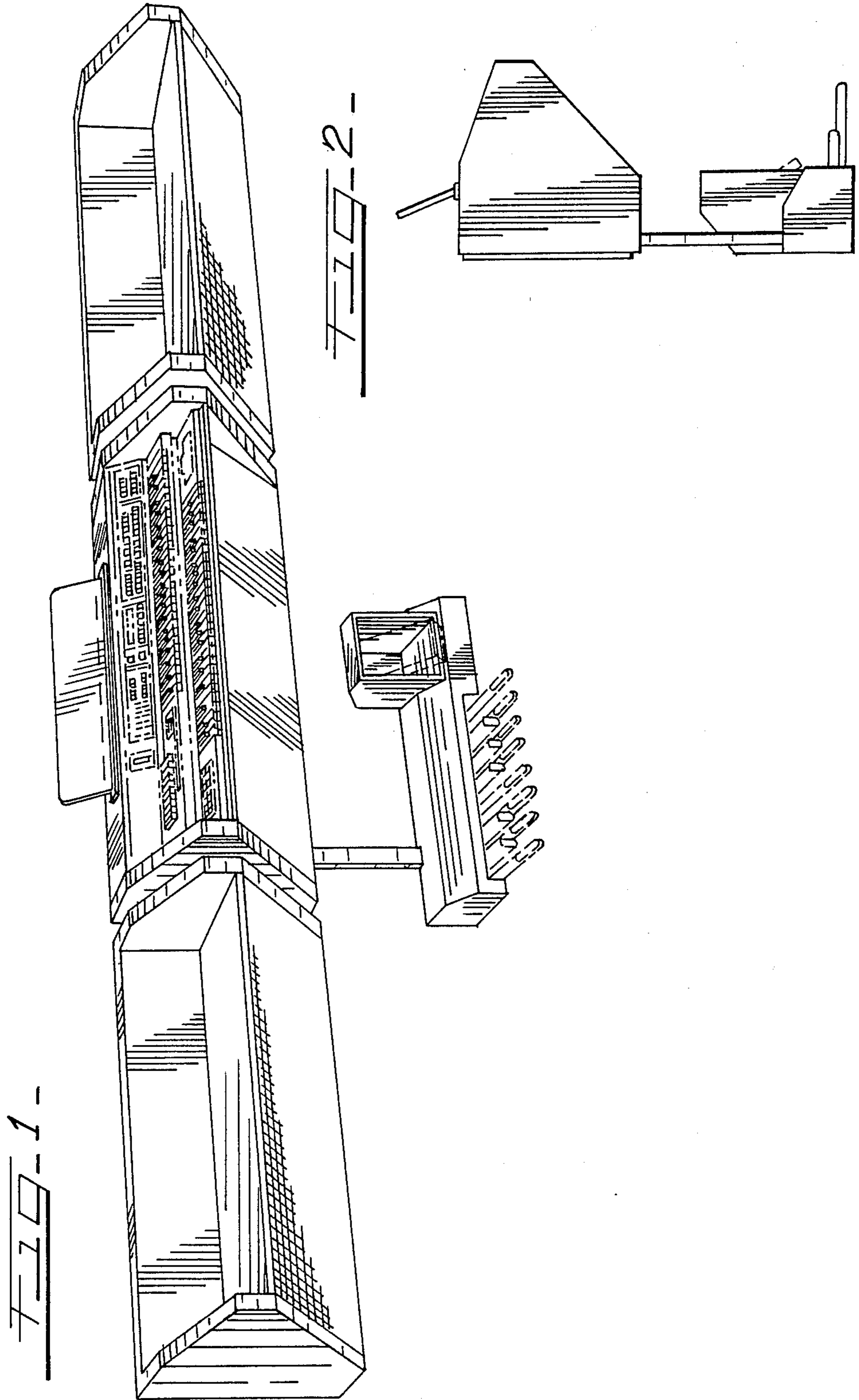

FIG-4-

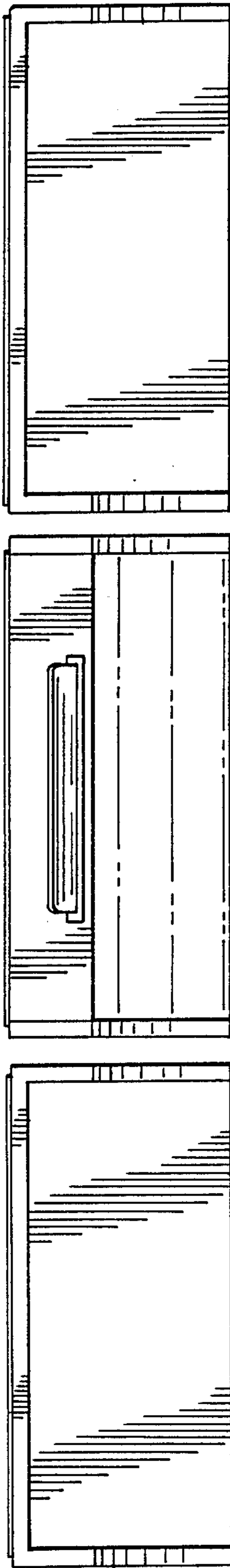

FIG-3-

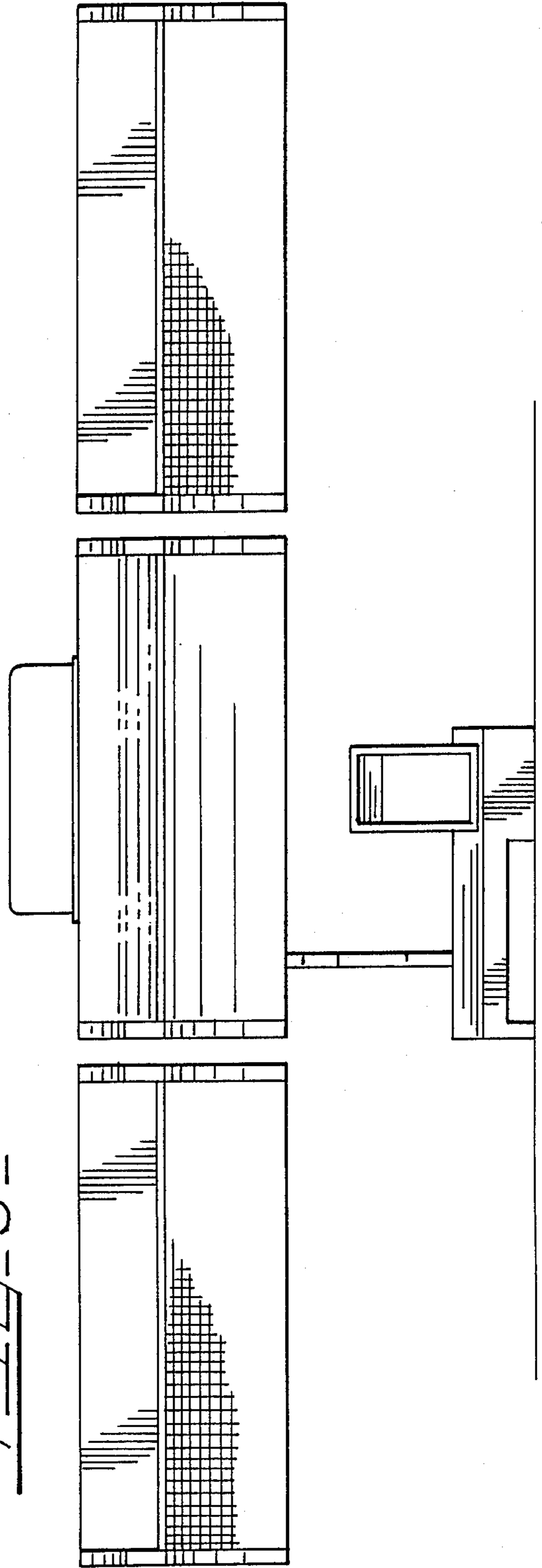

FIG-5-

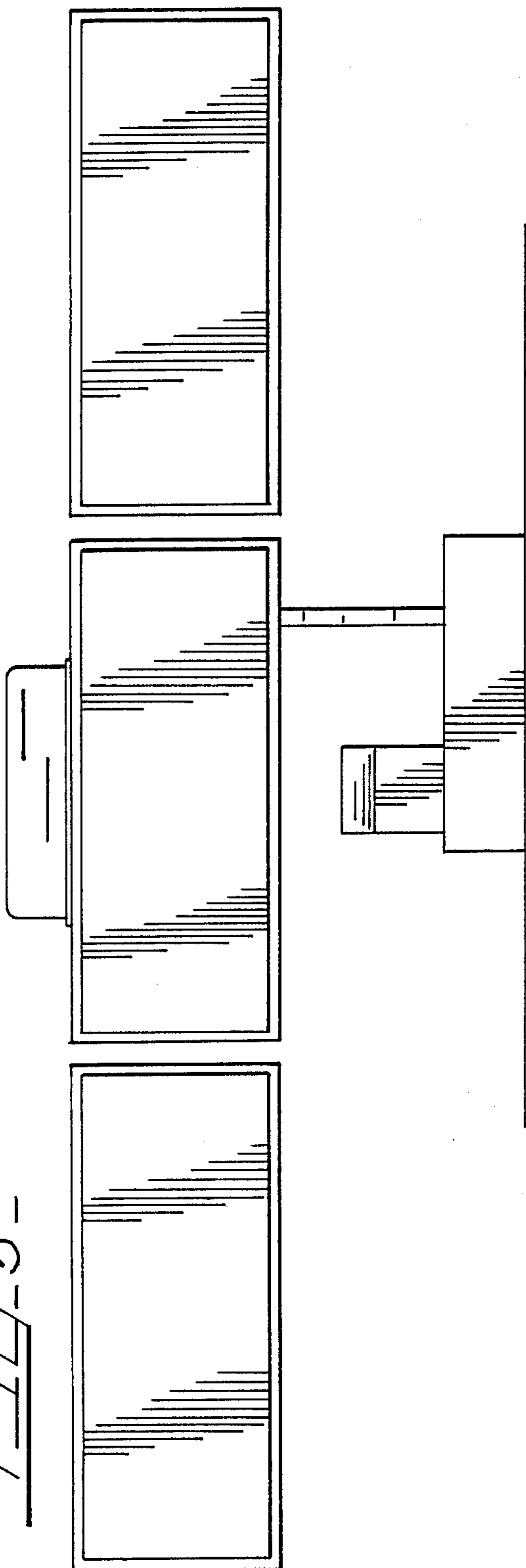
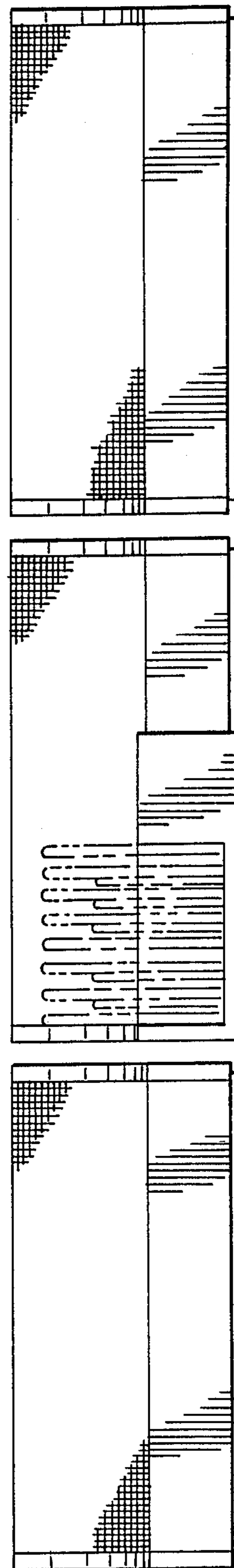

FIG-6-



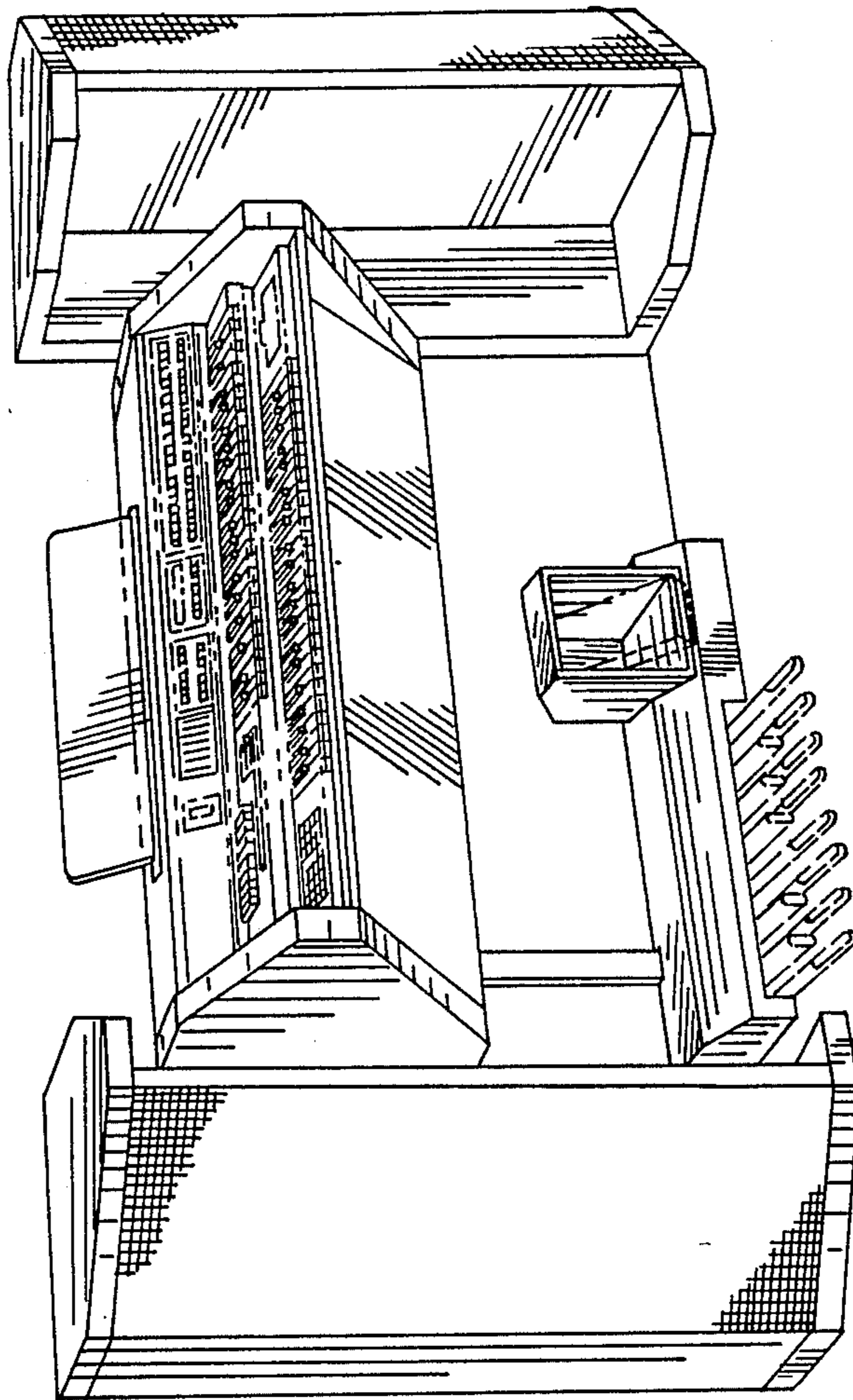

FIG. 7