

[54] CONTAINER

[75] Inventors: Charles W. Fitzloff, Mankato; Duane M. Regenscheid, Austin, both of Minn.

[73] Assignee: Geo. A. Hormel & Co., Austin, Minn.

[**] Term: 14 Years

[21] Appl. No.: 162,176

[22] Filed: Feb. 29, 1988

[52] U.S. Cl. D9/424; D9/425

[58] Field of Search D9/414-433; D34/40; 206/515, 55, 518, 557, 503, 457; 220/72, 74, 73, 83, 94 A; D7/30, 36, 37, 1

[56] References Cited

U.S. PATENT DOCUMENTS

D. 197,584	2/1964	Nascher et al.	D9/425
D. 250,870	1/1979	Stahel	D9/424 X
D. 275,886	10/1984	Sheward et al.	D9/425 X
2,889,072	6/1959	Lapham	206/507
3,005,572	10/1961	Gustafson et al.	220/94 A
3,077,284	2/1963	McLaughlin	220/72 X
3,153,505	10/1964	Bessett	206/457 X
3,443,717	5/1969	Wettlen et al.	220/83 X
4,641,005	2/1987	Seiferth	219/10.55

Primary Examiner—Bernard Ansher
Assistant Examiner—Prabhakar Deshmukh

Attorney, Agent, or Firm—Merchant, Gould, Smith, Edell, Welter & Schmidt

[57] CLAIM

The ornamental design for container design, as shown and described.

DESCRIPTION

FIG. 1 is a perspective view of a container showing my new design;
 FIG. 2 is a top plan view thereof;
 FIG. 3 is a left side elevation thereof, the right side elevation being a mirror image;
 FIG. 4 is a bottom plan view thereof;
 FIG. 5 is a front elevation thereof, the rear side elevation being a mirror image;
 FIG. 6 is a perspective view of a first embodiment of FIG. 1;
 FIG. 7 is a top plan view of FIG. 6;
 FIG. 8 is a left side elevation of FIG. 6, the right side elevation being a mirror image;
 FIG. 9 is a bottom plan view of FIG. 6;
 FIG. 10 is a front elevation of FIG. 6, the rear side elevation being a mirror image;
 FIG. 11 is a perspective view of a second embodiment of FIG. 1;
 FIG. 12 is a top plan view of FIG. 11;
 FIG. 13 is a left side elevation of FIG. 11, the right side elevation being a mirror image;
 FIG. 14 is a bottom plan view of FIG. 11; and
 FIG. 15 is a front elevation of FIG. 11, the rear side elevation being a mirror image.

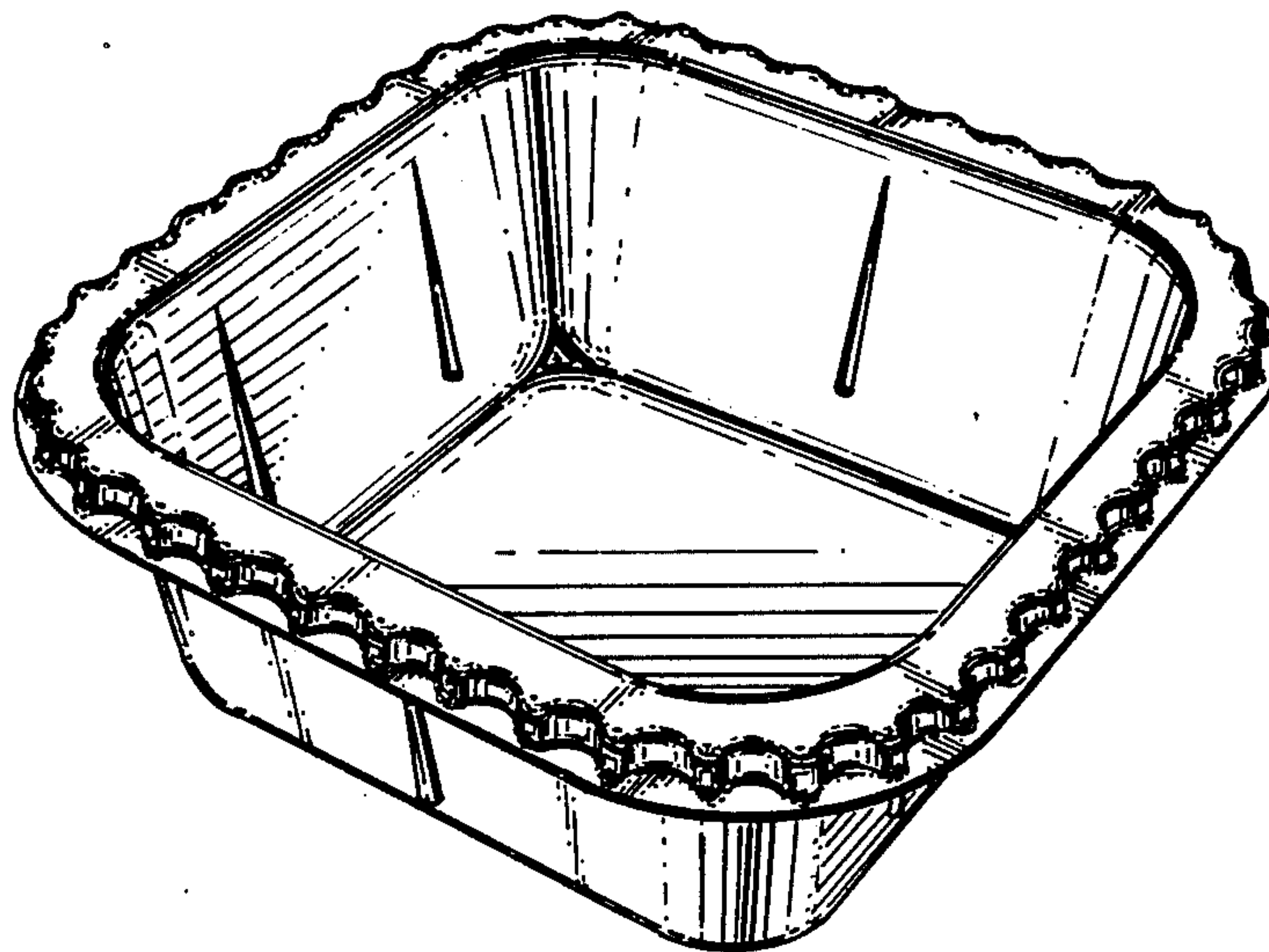

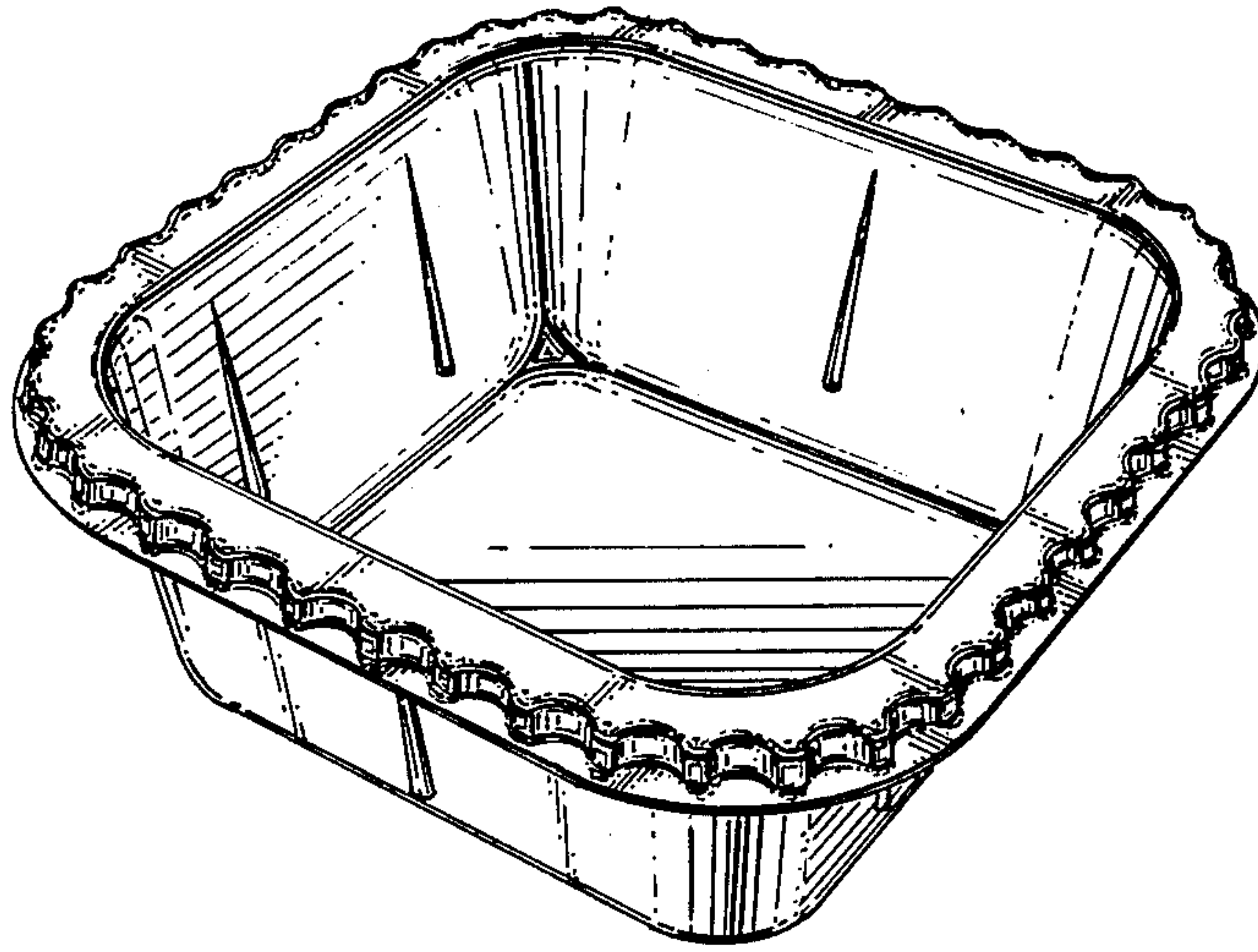

FIG. 1

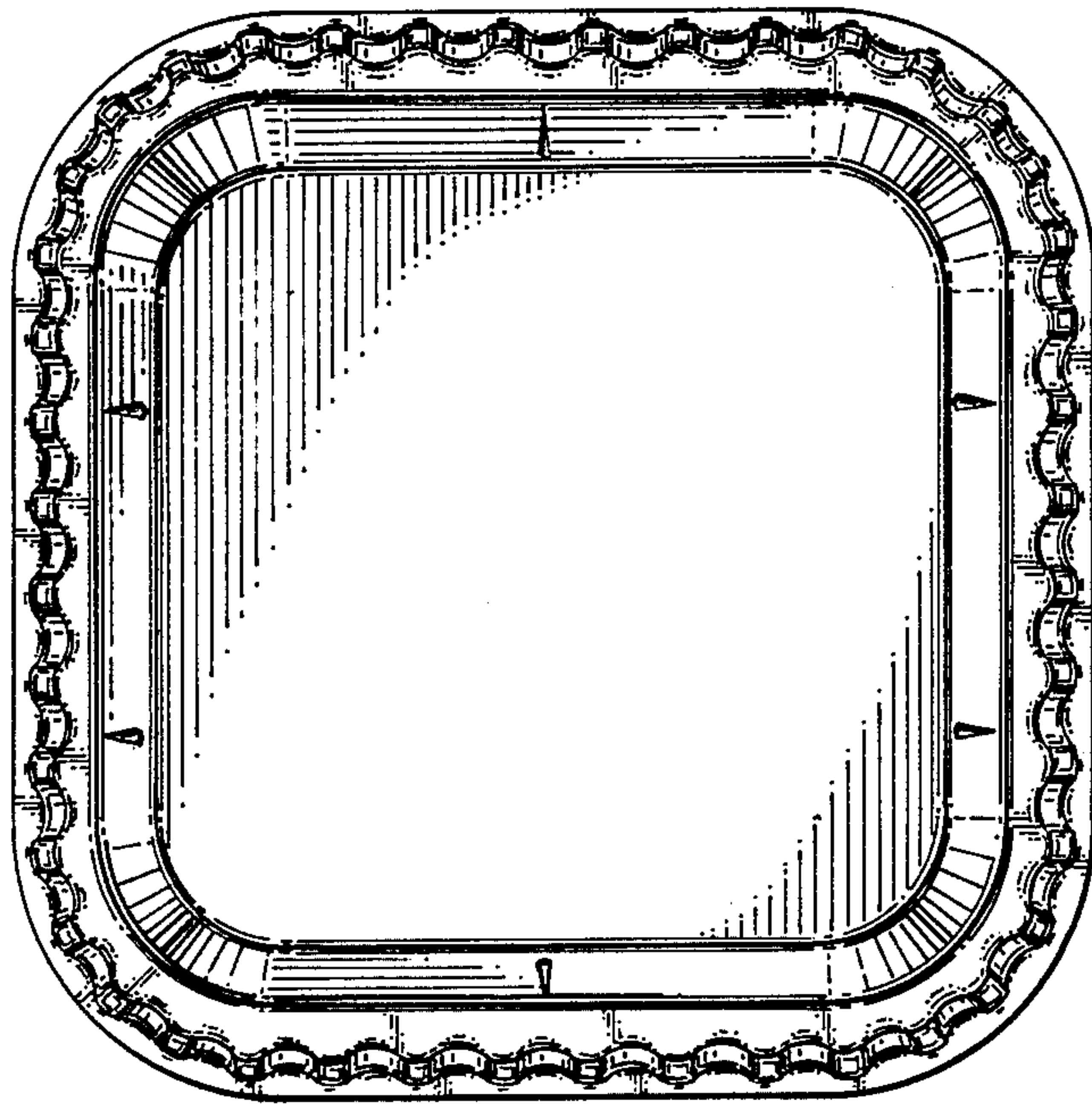

FIG. 2

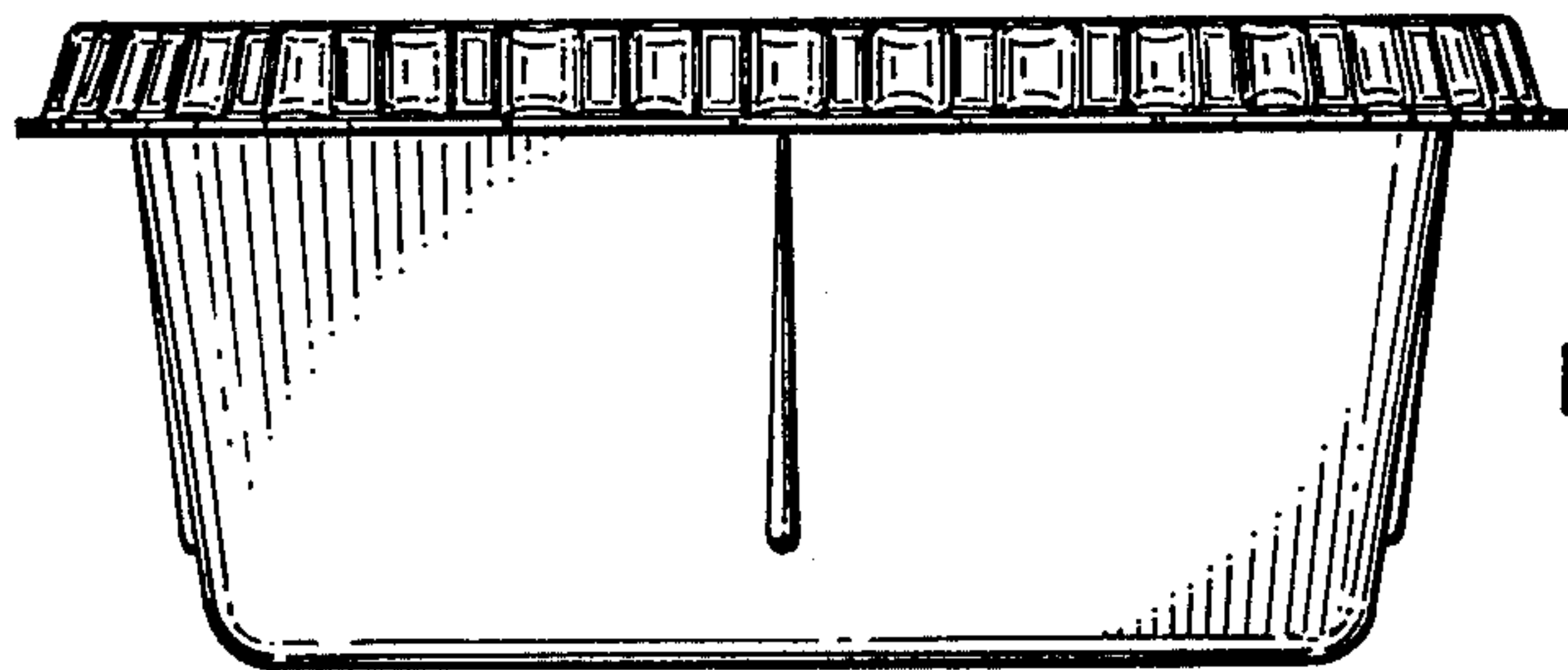

FIG. 3

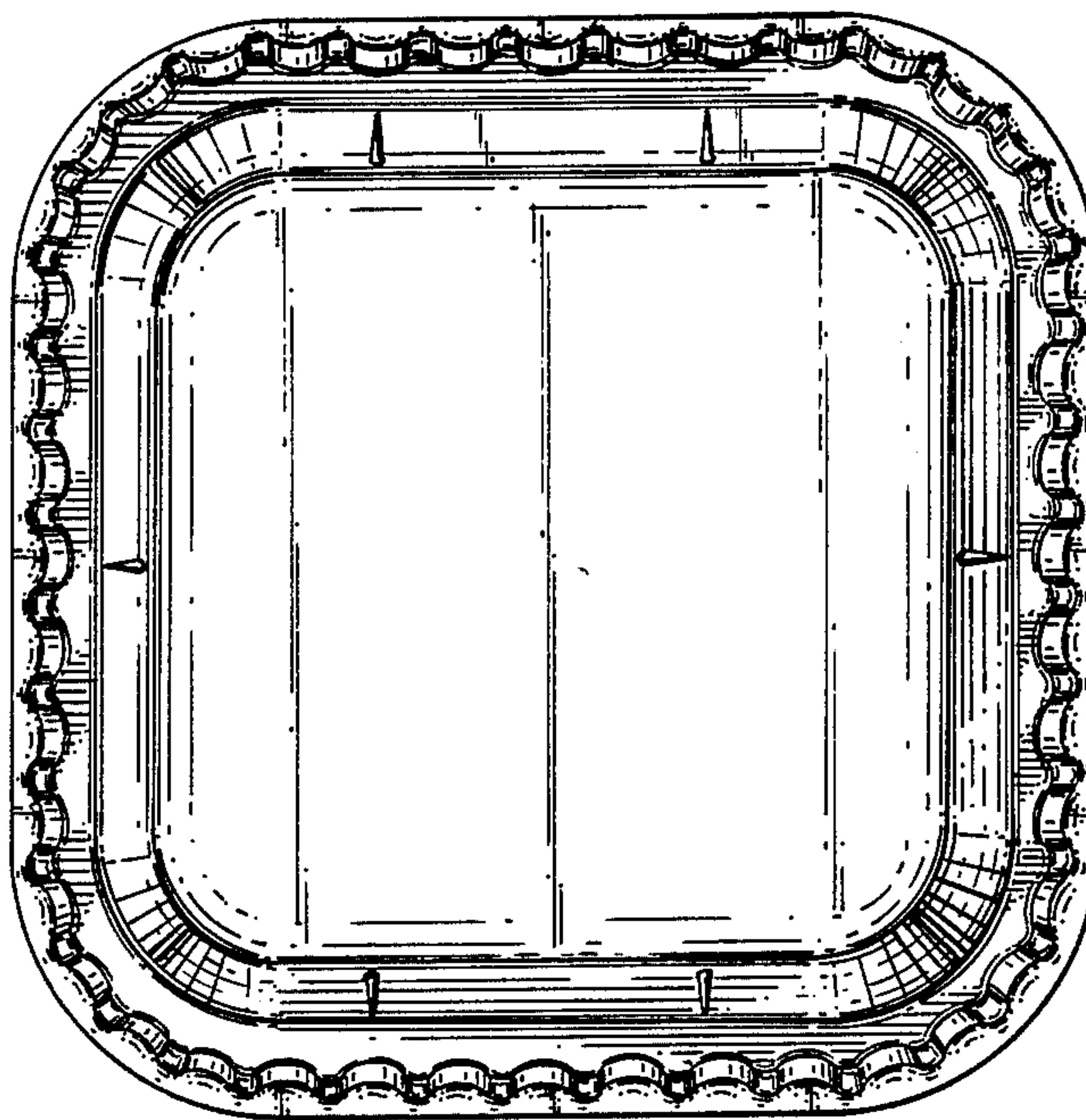

FIG. 4

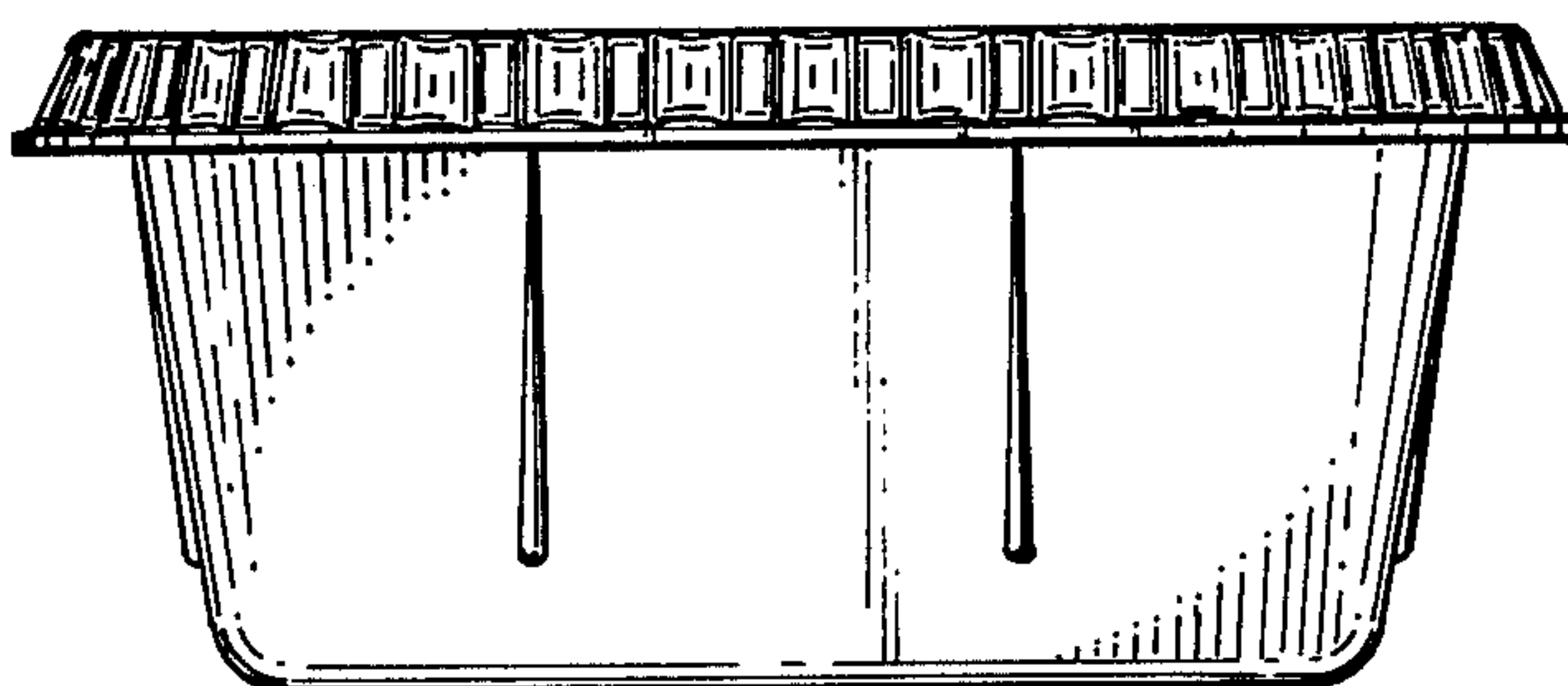

FIG. 5

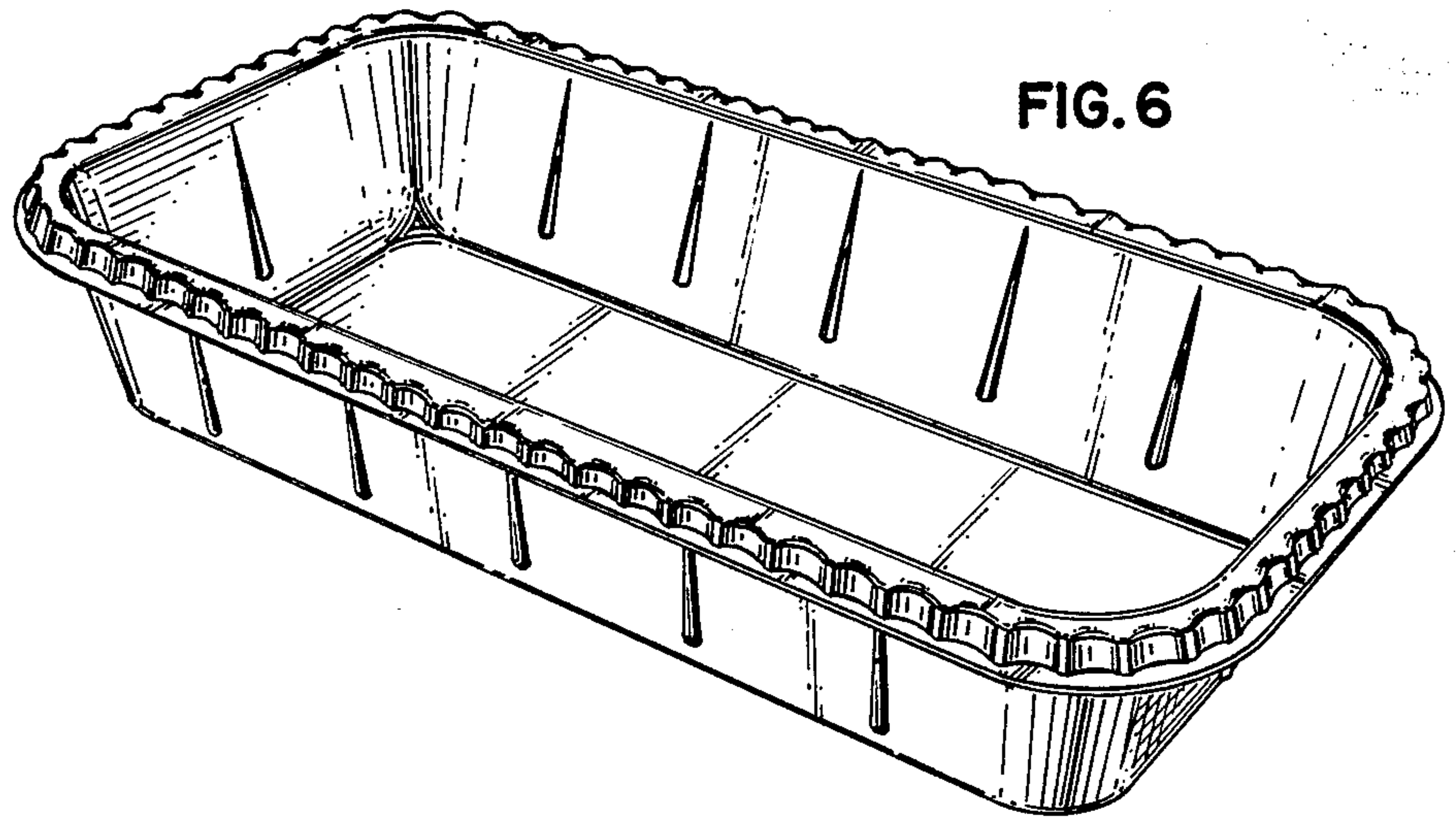

FIG. 6

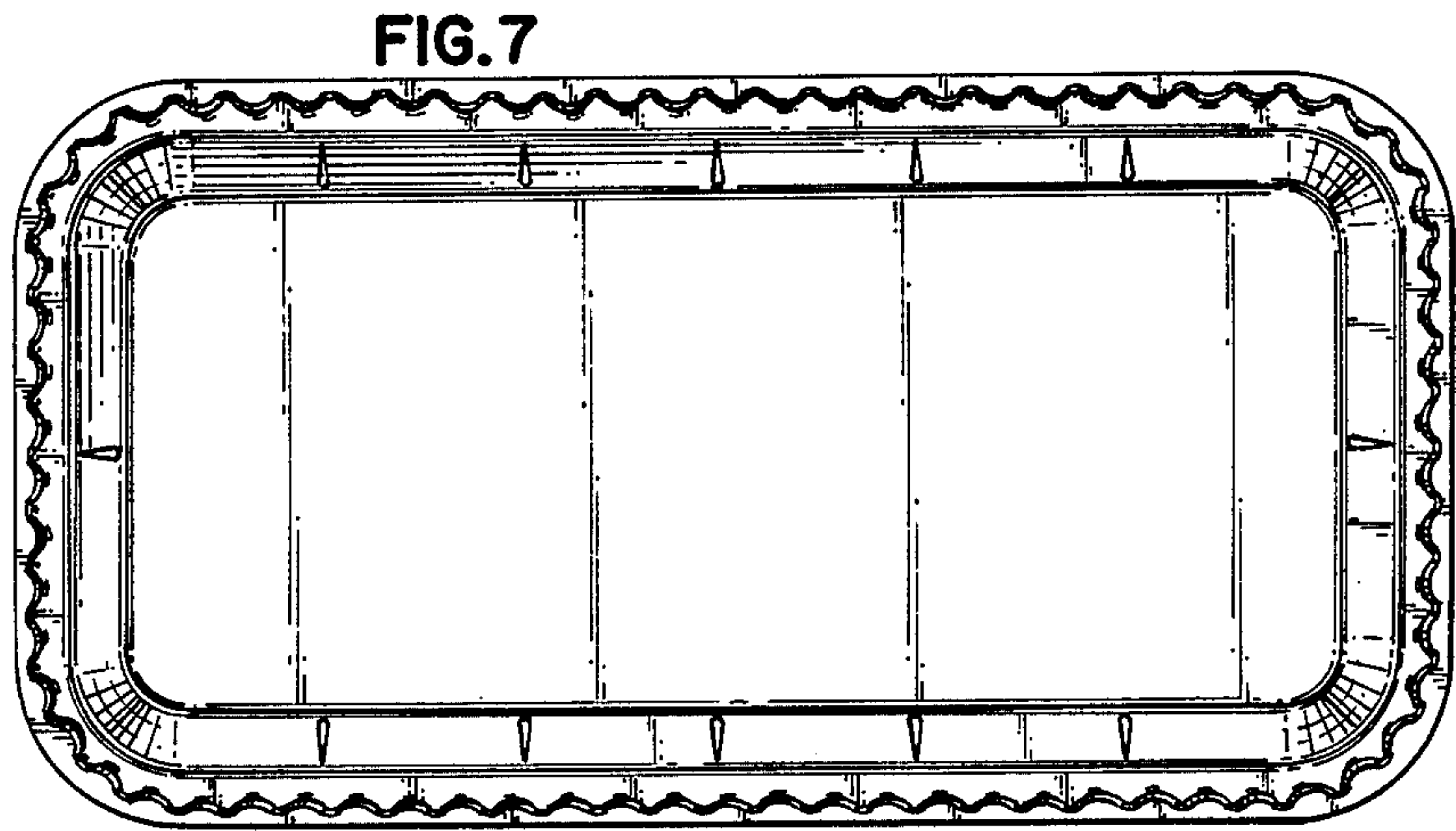

FIG. 7

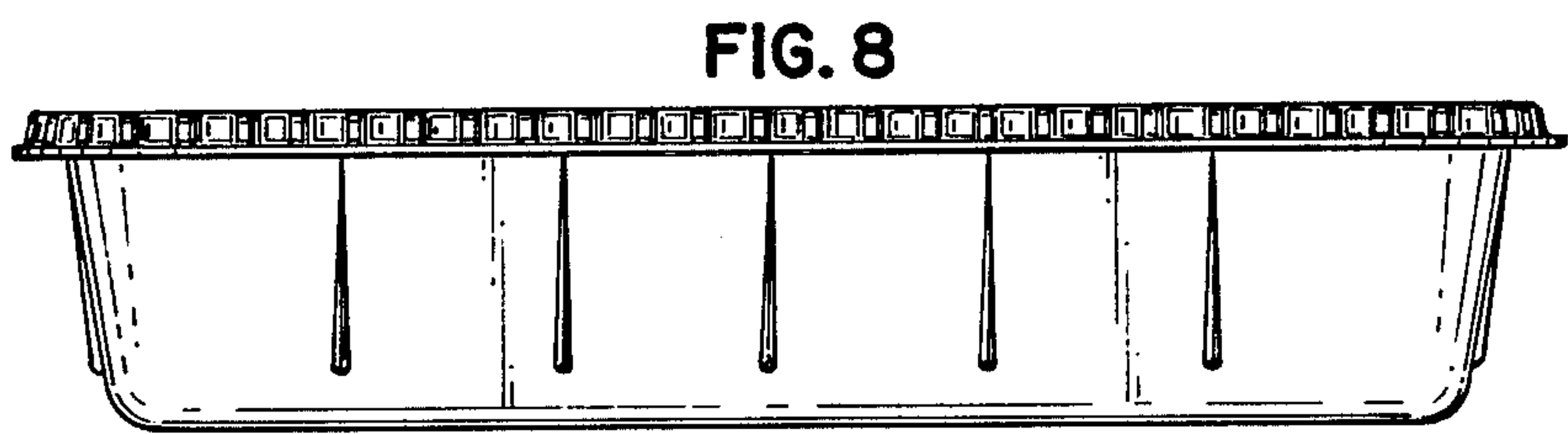

FIG. 8

FIG. 9

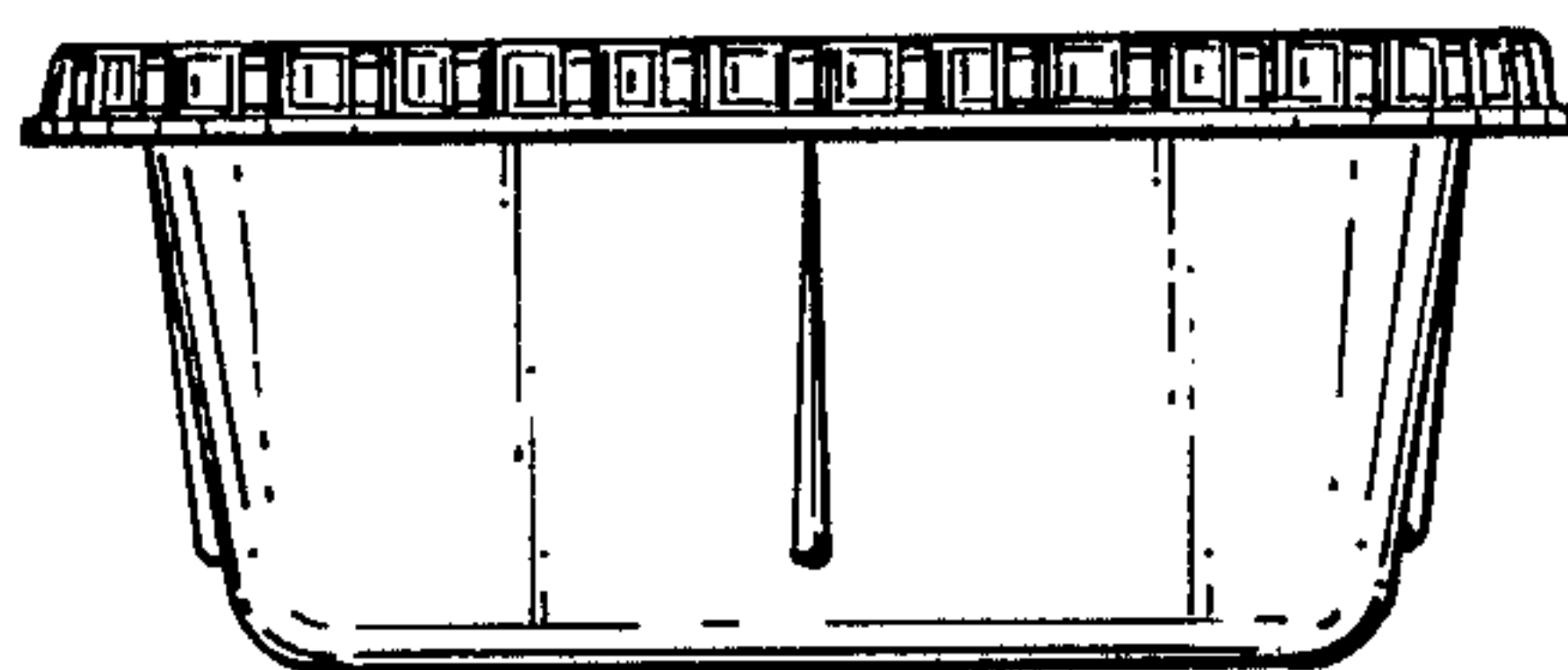
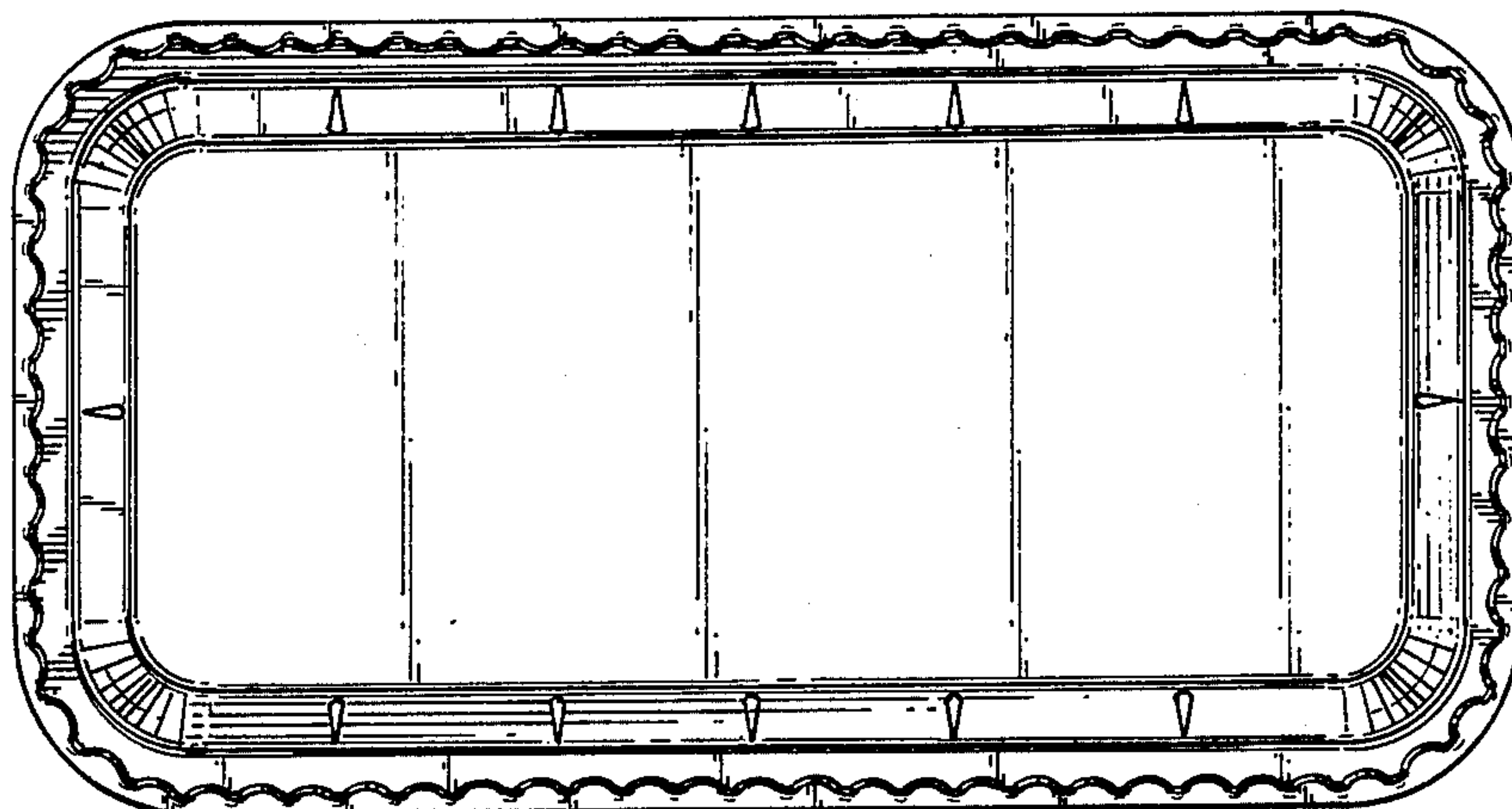

FIG. 10

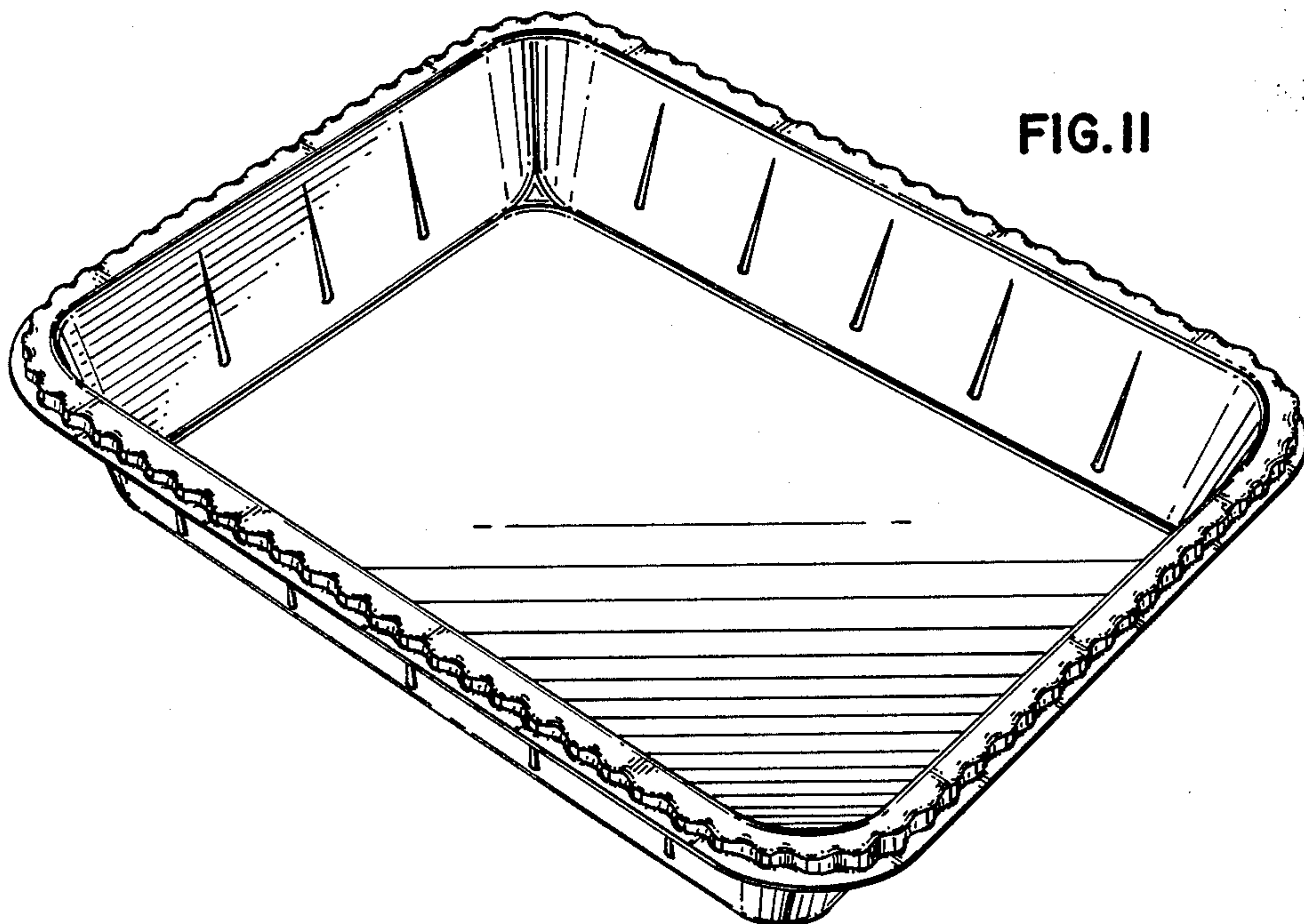

FIG. II

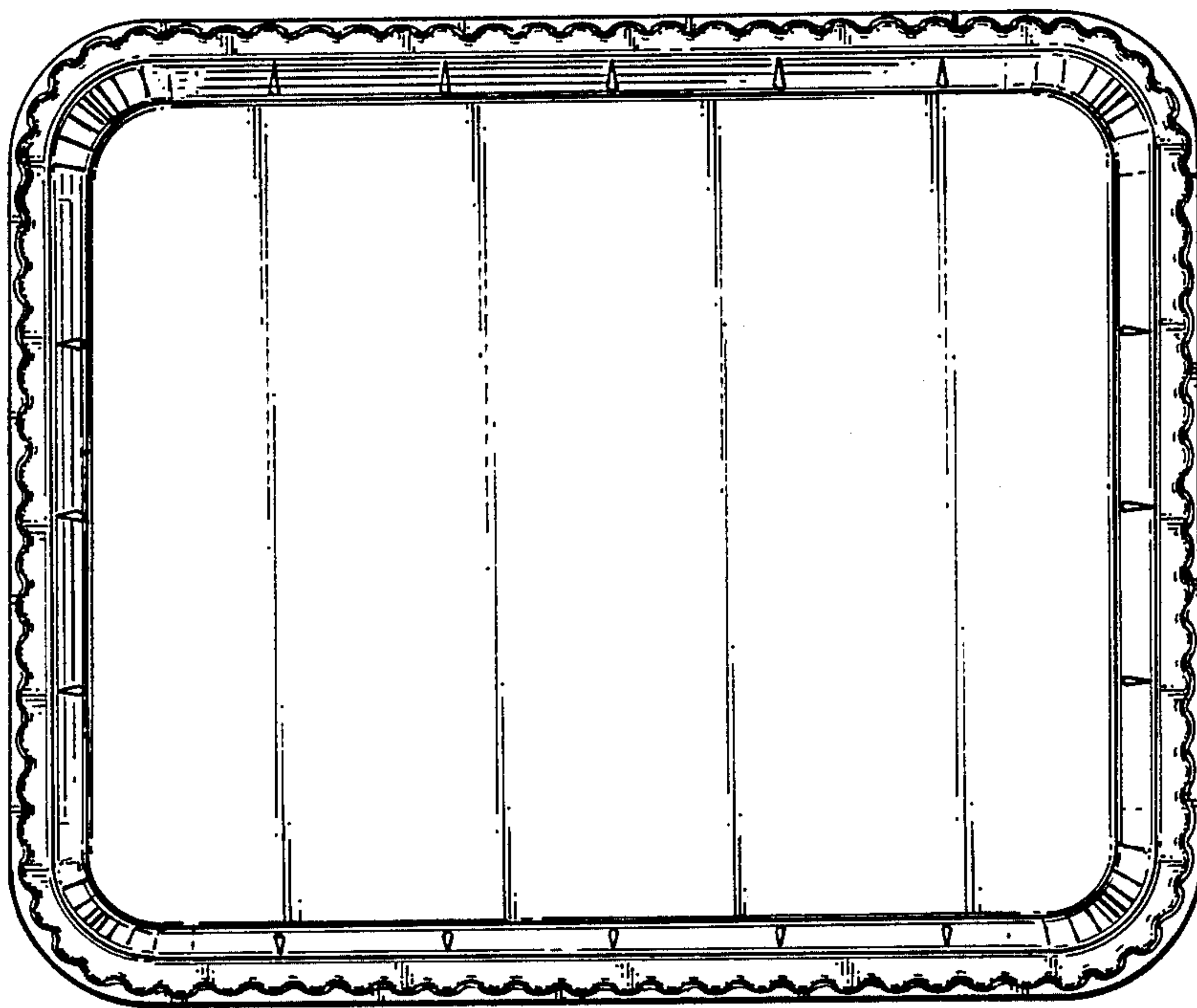

FIG. I2

FIG. 13

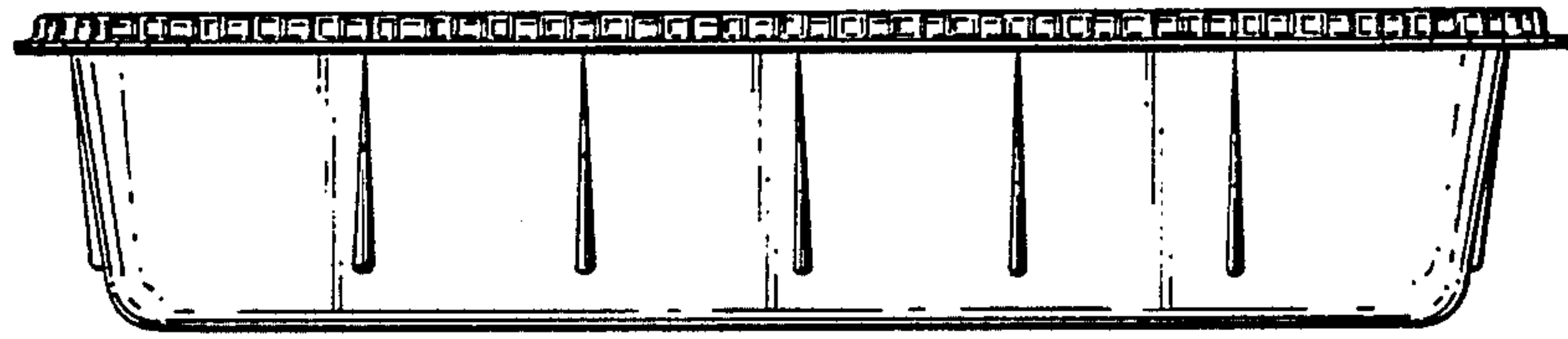

FIG. 14

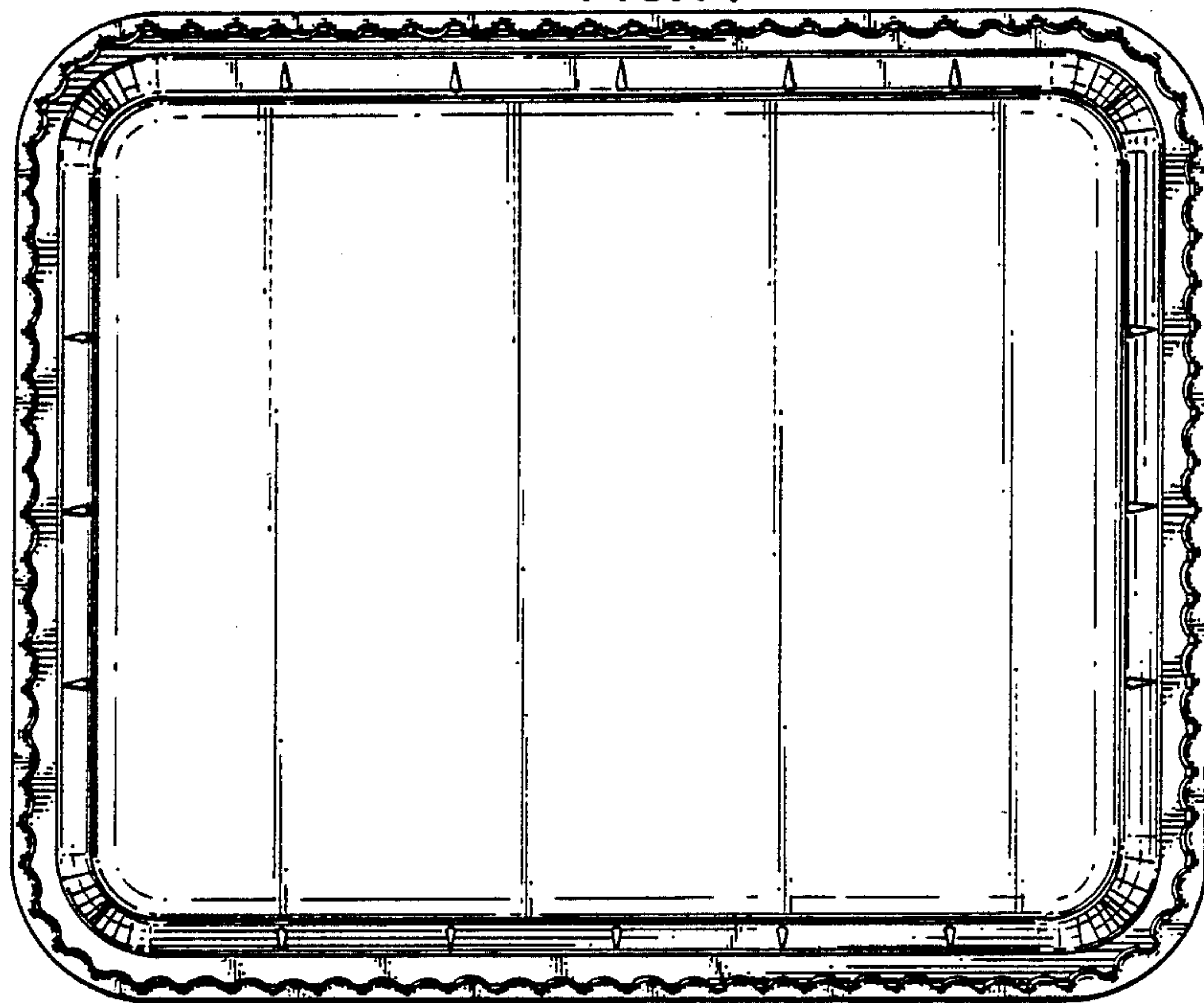

FIG. 15

