

[54] **STAND FOR A WAX-APPLICATOR**

[75] **Inventor: Hans T. Meelen, Drachten, Netherlands**

[73] **Assignee: U.S. Philips Corporation, New York, N.Y.**

[**] **Term: 14 Years**

[21] **Appl. No.: 62,819**

[22] **Filed: Jun. 15, 1987**

[30] **Foreign Application Priority Data**

Dec. 18, 1986 [IB] Int'l Pat. Institute 61692-02
[52] **U.S. Cl. D28/9**
[58] **Field of Search 210/175; 261/DIG. 3; 401/1; D7/363; 427/429**

[56] **References Cited**

U.S. PATENT DOCUMENTS

4,773,784 9/1988 Mann 401/1

Primary Examiner—Bernard Ansher

Assistant Examiner—David Jeo

[57] **CLAIM**

The ornamental design for a stand for a wax-applicator, as shown and described.

DESCRIPTION

FIG. 1 is a front, top and right side perspective view showing my new design;
FIG. 2 is a front elevational view thereof;
FIG. 3 is a rear elevational view thereof;
FIG. 4 is a right side elevational view thereof;
FIG. 5 is a left side elevational view thereof;
FIG. 6 is a top plan view thereof; and
FIG. 7 is a bottom plan view thereof.

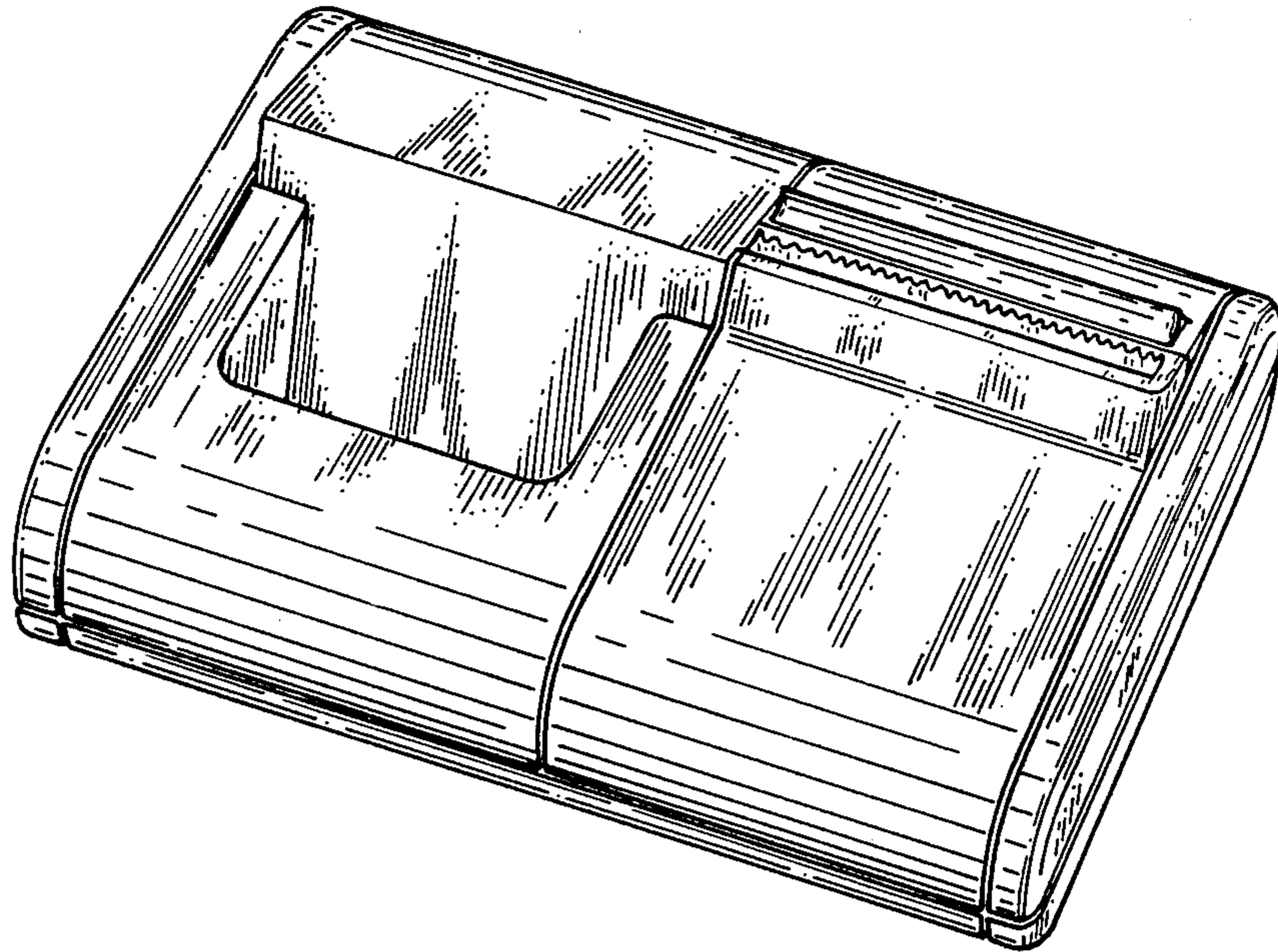

FIG. 1

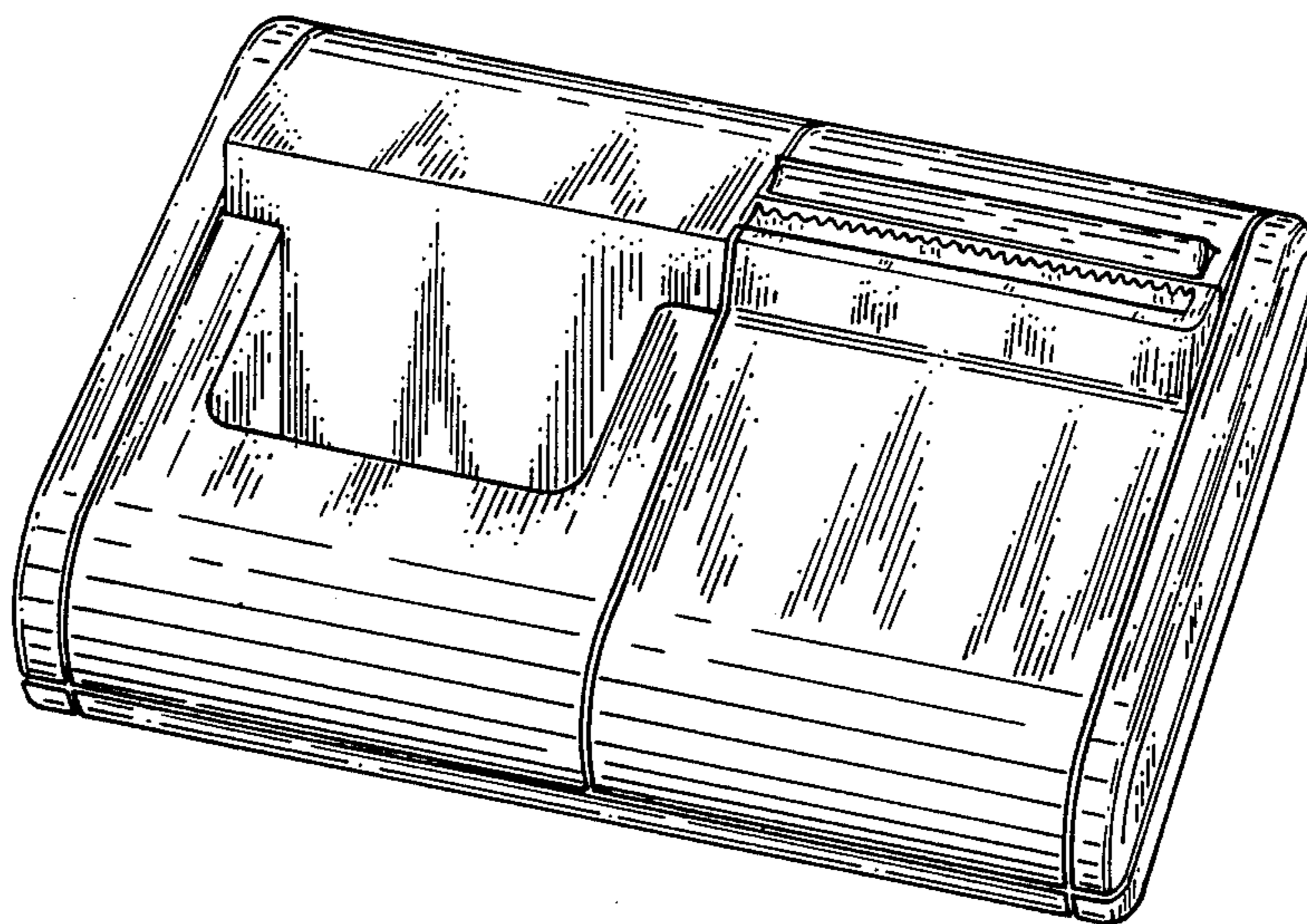

FIG. 2

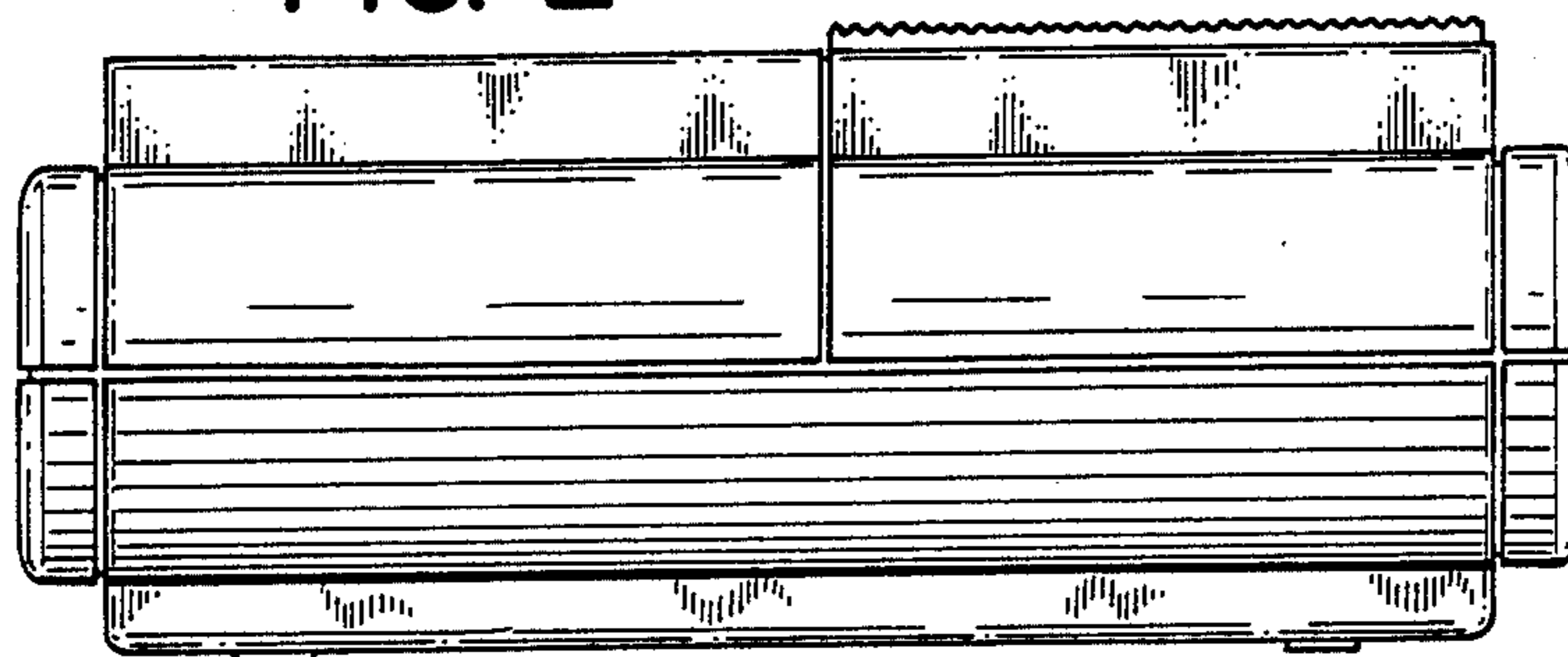

FIG. 3

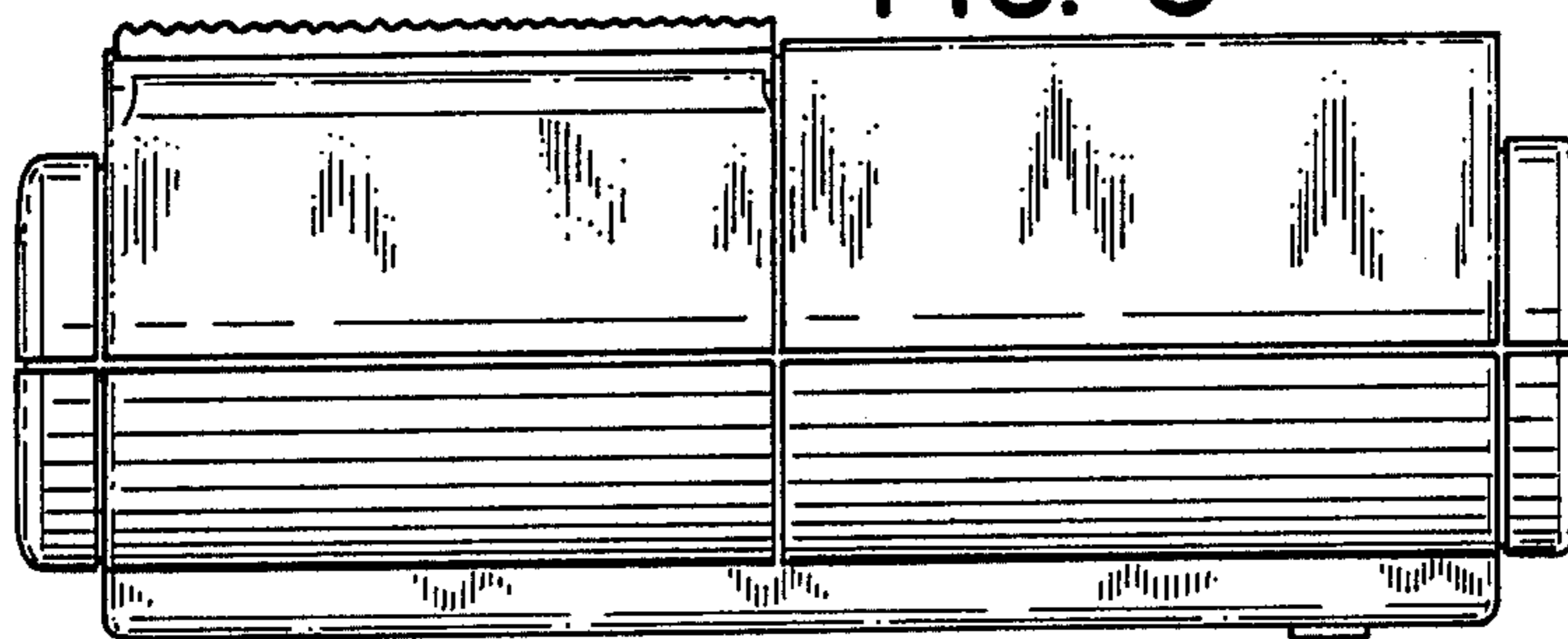

FIG. 4

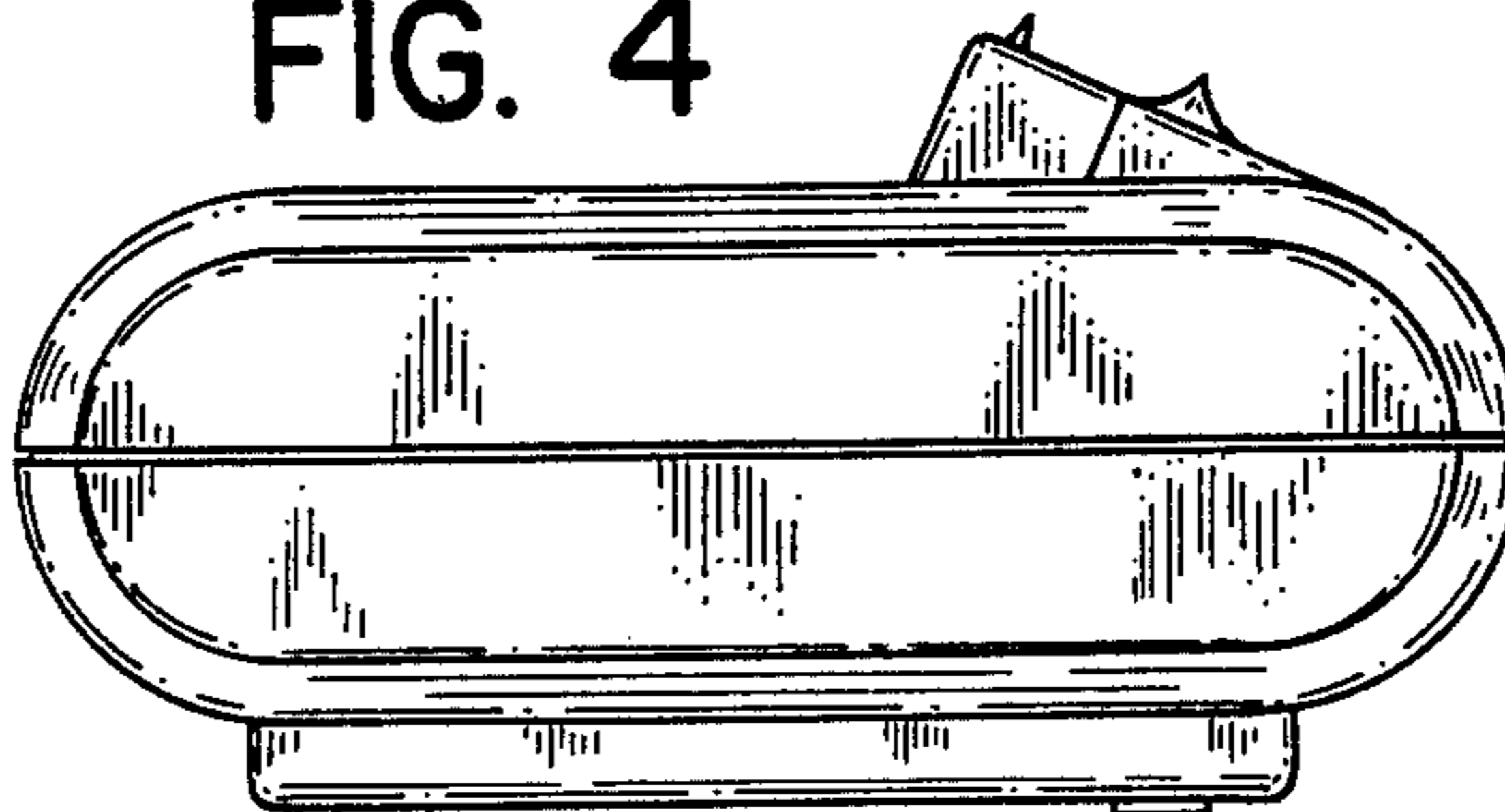

FIG. 5

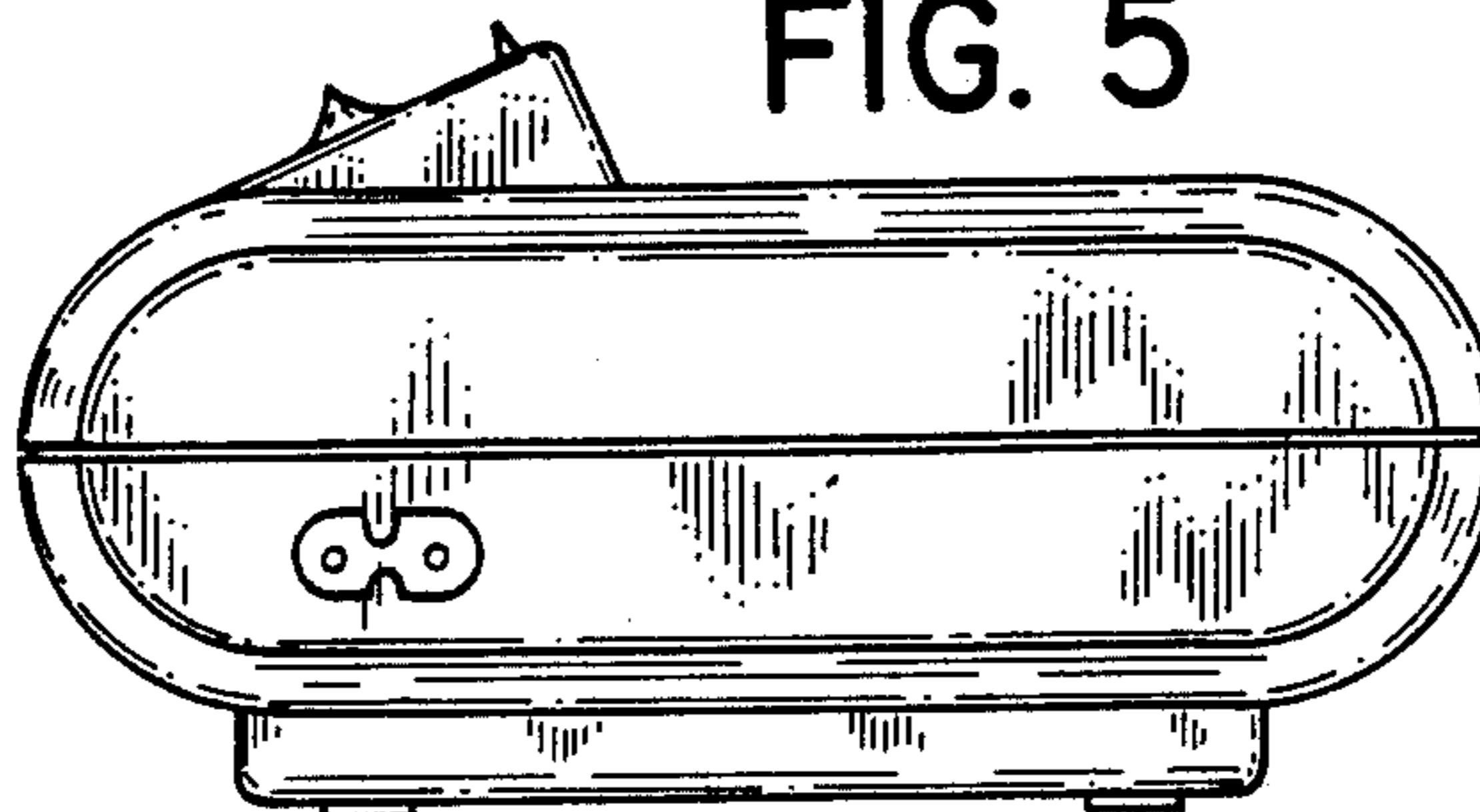

FIG. 6

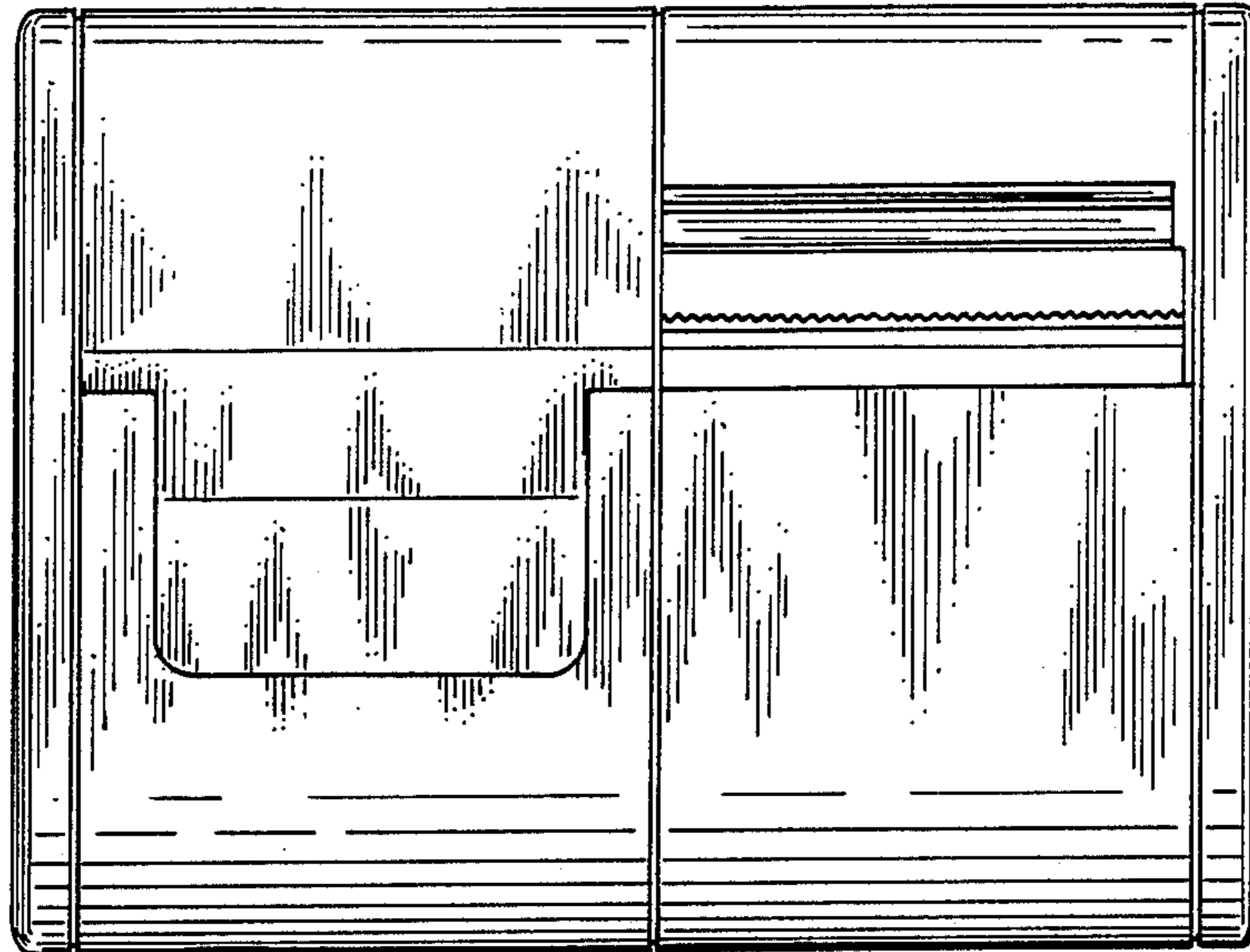

FIG. 7

