

[54] **COMBINED CONFECTIONERY TRAY, ADVERTISING HOLDER AND DONATION BOX**

[76] **Inventor: Charles E. Silcox, Rte. #3, Box 499, Proctorville, Ohio 45669**

[*] **Notice: The portion of the term of this patent subsequent to Nov. 14, 2003 has been disclaimed.**

[**] **Term: 14 Years**

[21] **Appl. No.: 921,011**

[22] **Filed: Oct. 17, 1986**

Related U.S. Application Data

[63] **Continuation-in-part of Ser. No. 886,508, Jul. 16, 1986.**

[52] **U.S. Cl. D99/36; D9/347; D9/415**

[58] **Field of Search D99/34, 35, 36, 43, D99/28; D6/440, 474, 476, 475; D19/92, 87, 86, 75; 206/0.8, 0.82, 0.83, 0.84, 0.81; D9/347, 415, 414**

[56] **References Cited**

U.S. PATENT DOCUMENTS

D. 22,290	3/1893	Burnworth	D9/347
D. 107,251	11/1937	Noren	D9/347
D. 292,220	10/1987	Wen	D19/92
706,231	8/1902	Goldman	232/1 D

727,211	5/1903	Schweer	206/0.81 X
837,442	12/1906	Whitehead	232/1 D
4,671,455	6/1987	Stockman	232/1 D

Primary Examiner—Winifred E. Herrmann
Attorney, Agent, or Firm—Biebel, French & Nauman

[57] **CLAIM**

The ornamental design for a combined confectionery tray, advertising holder and donation box, as shown and described.

DESCRIPTION

FIG. 1 is a perspective view of a combined confectionery tray, advertising holder and donation box showing my new design;

FIG. 2 is a top plan view thereof;

FIG. 3 is a left side elevational view thereof;

FIG. 4 is a bottom plan view thereof;

FIG. 5 is a right side elevational view thereof;

FIG. 6 is a rear elevational view thereof;

FIG. 7 is a front elevational view thereof;

FIG. 8 is a perspective view of a combined confectionery tray, advertising holder and donation box showing a modification of my new design;

FIG. 9 is a top plan view thereof;

FIG. 10 is a left side elevational view thereof;

FIG. 11 is a bottom plan view thereof;

FIG. 12 is a right side elevational view thereof;

FIG. 13 is a rear elevational view thereof; and

FIG. 14 is a front elevational view thereof.

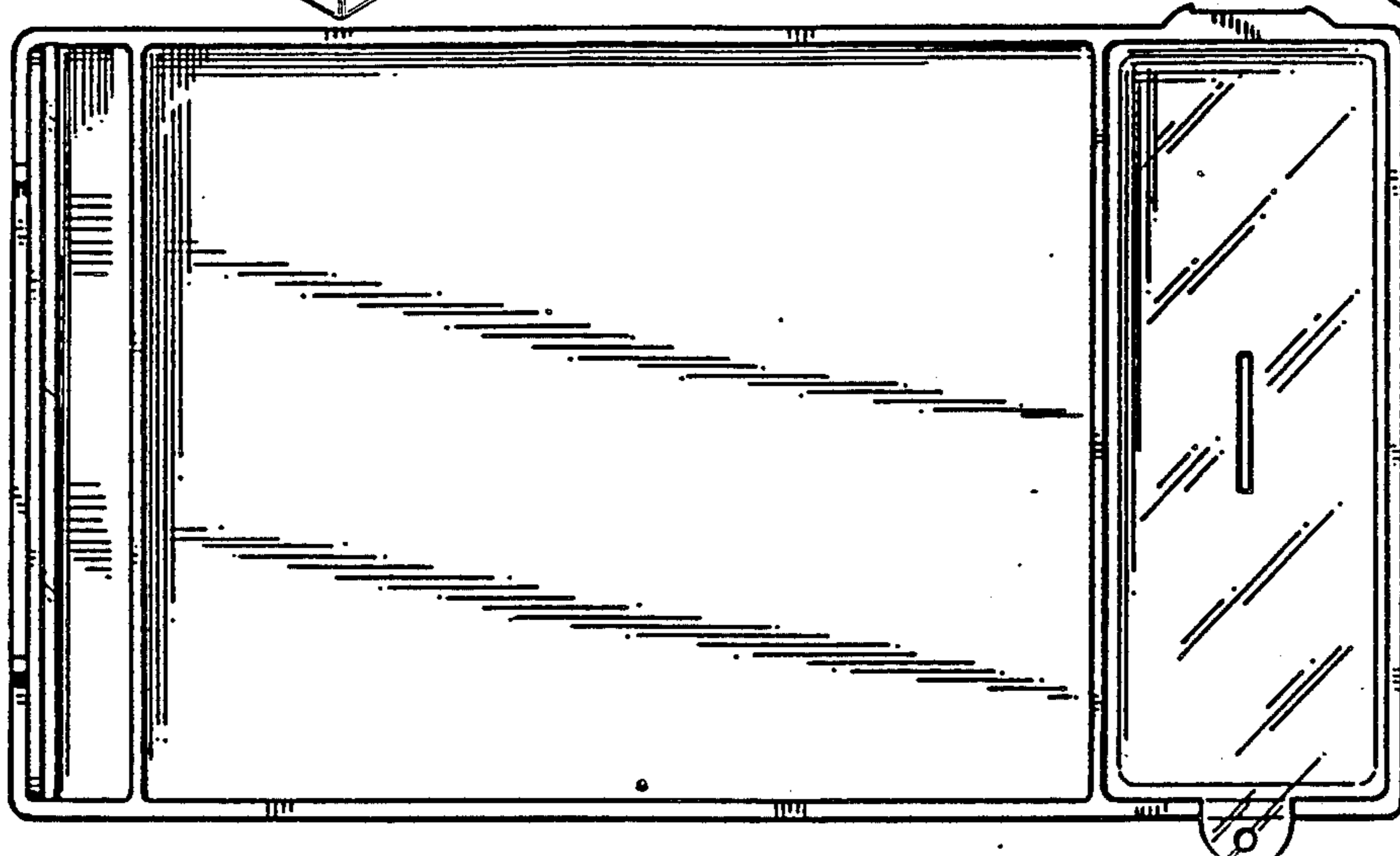
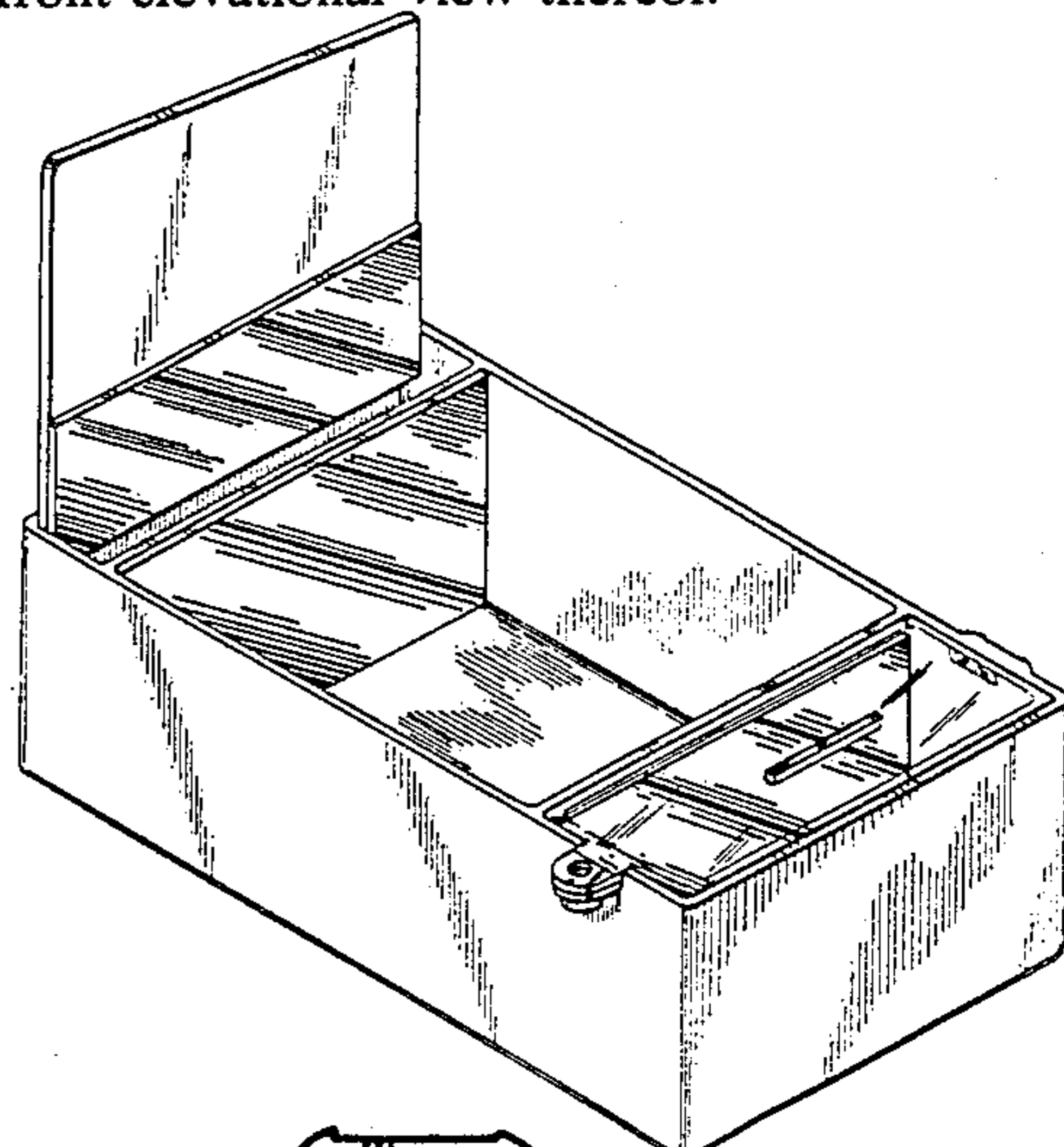
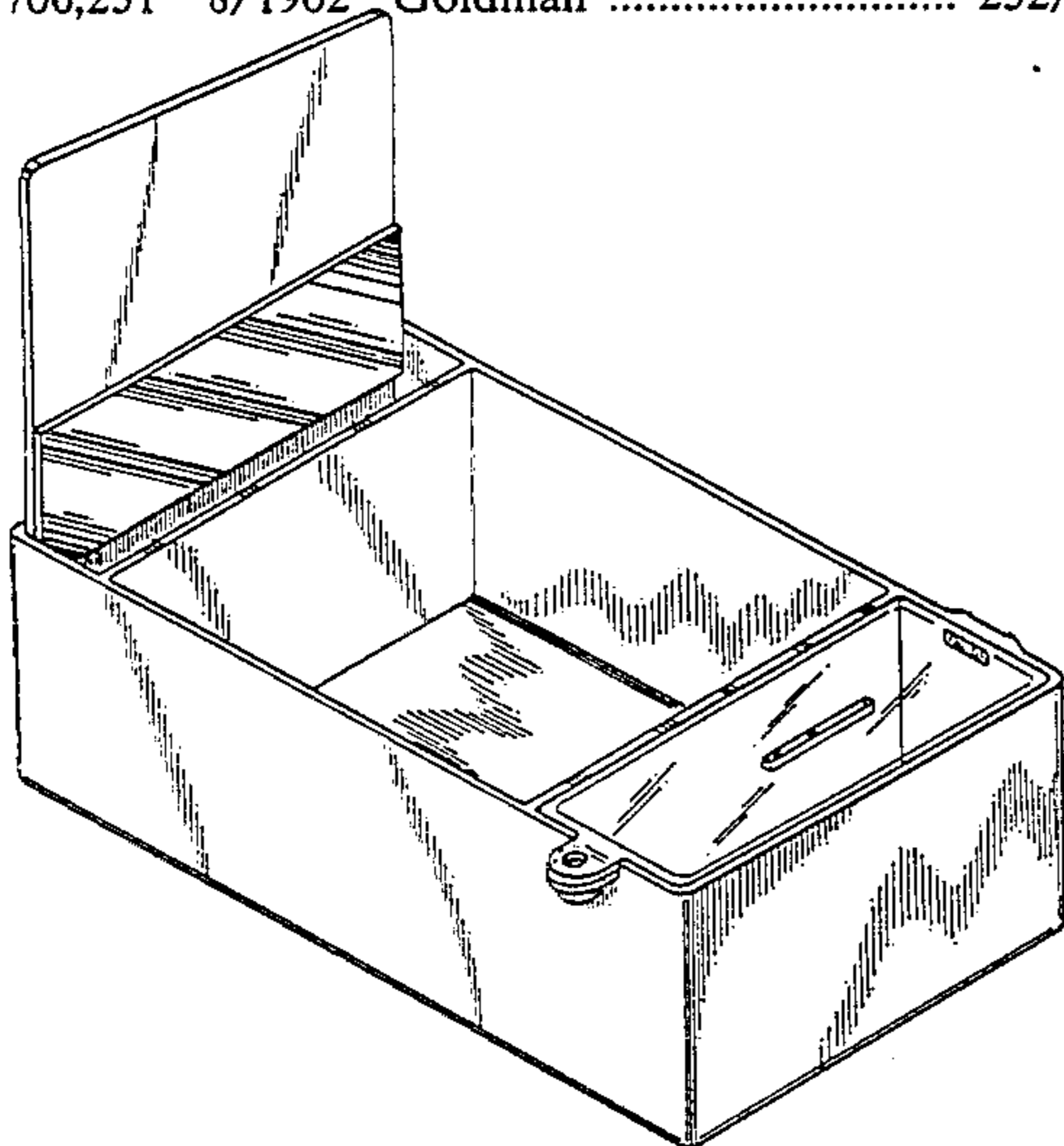

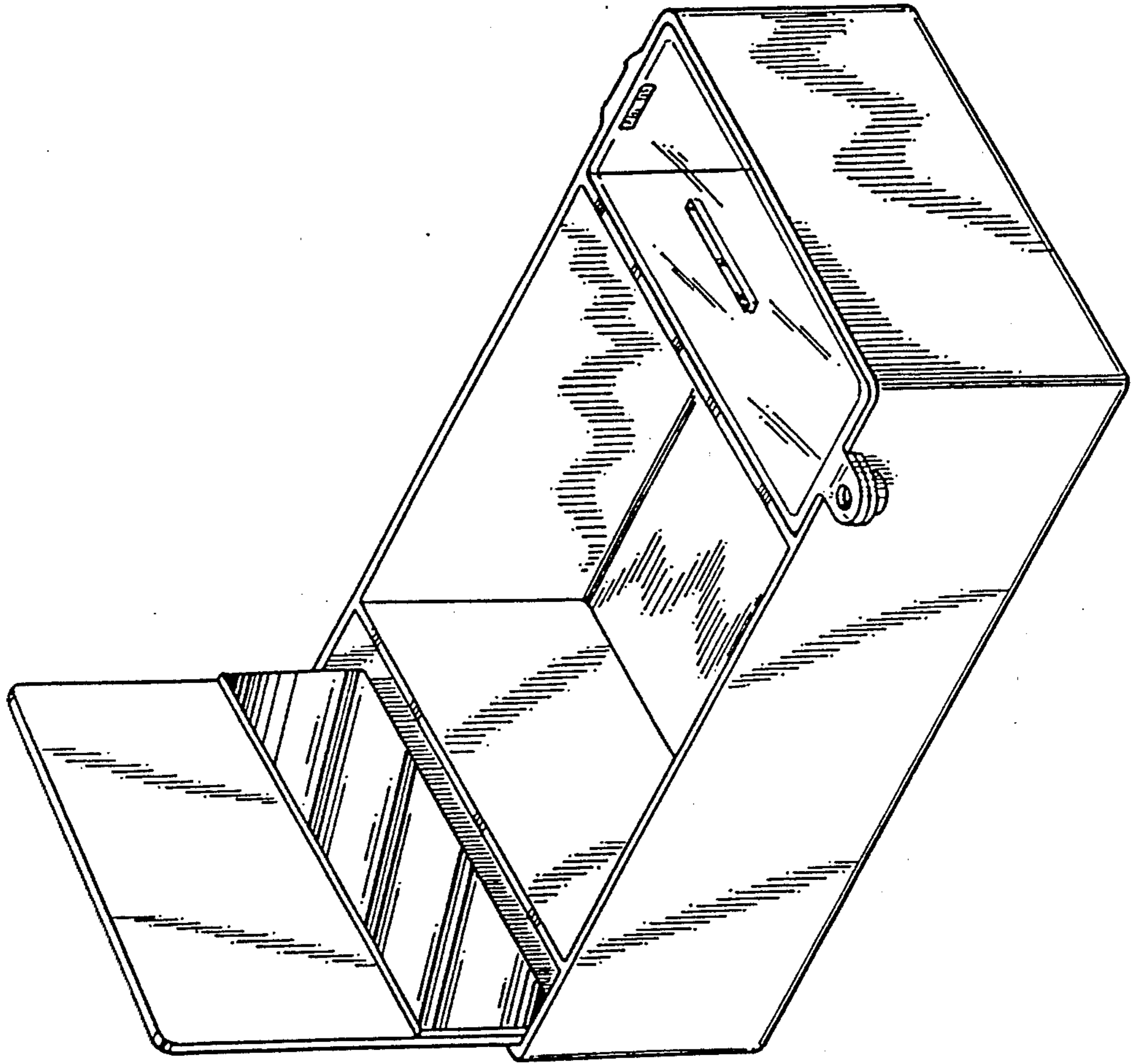

FIG-1

FIG-2

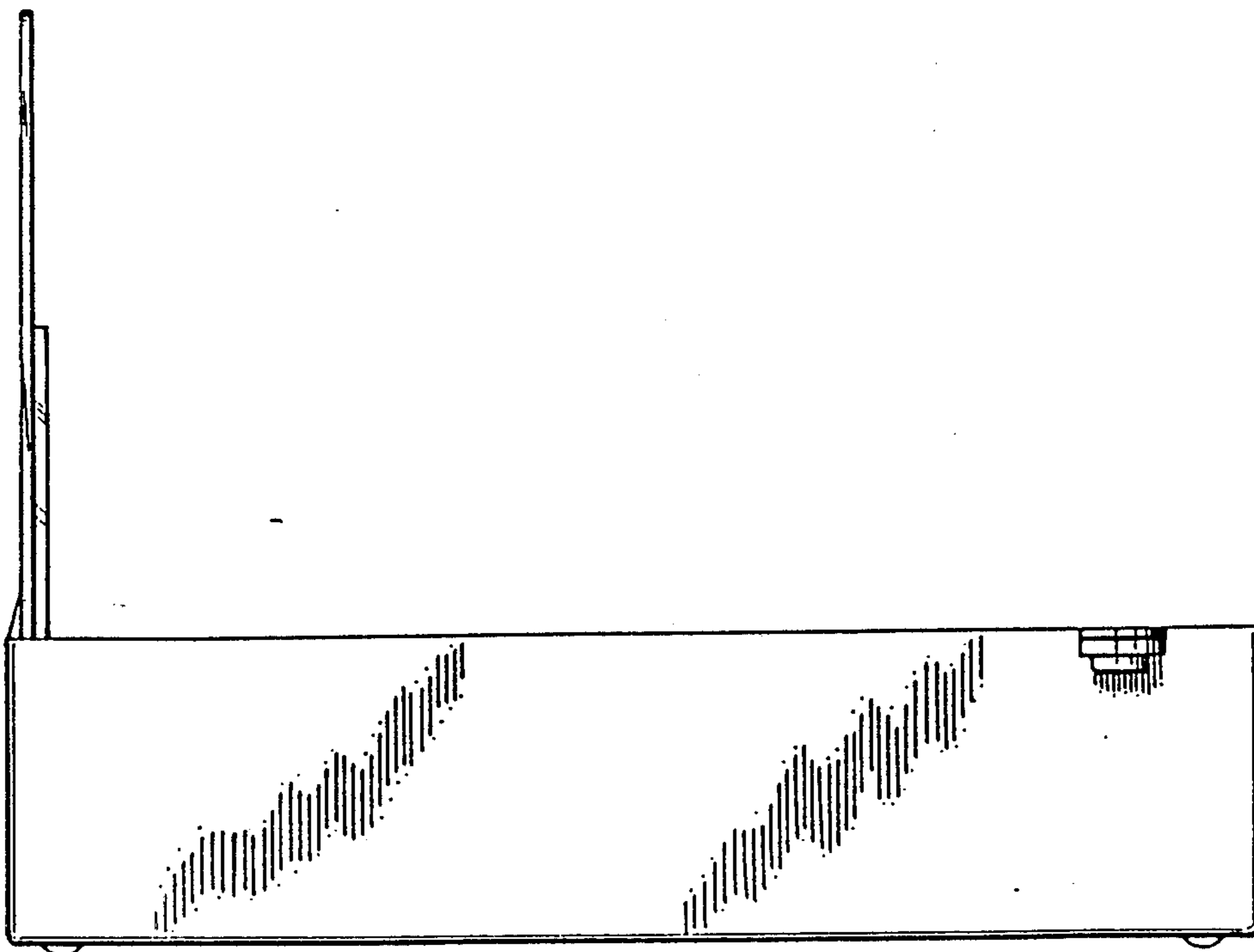
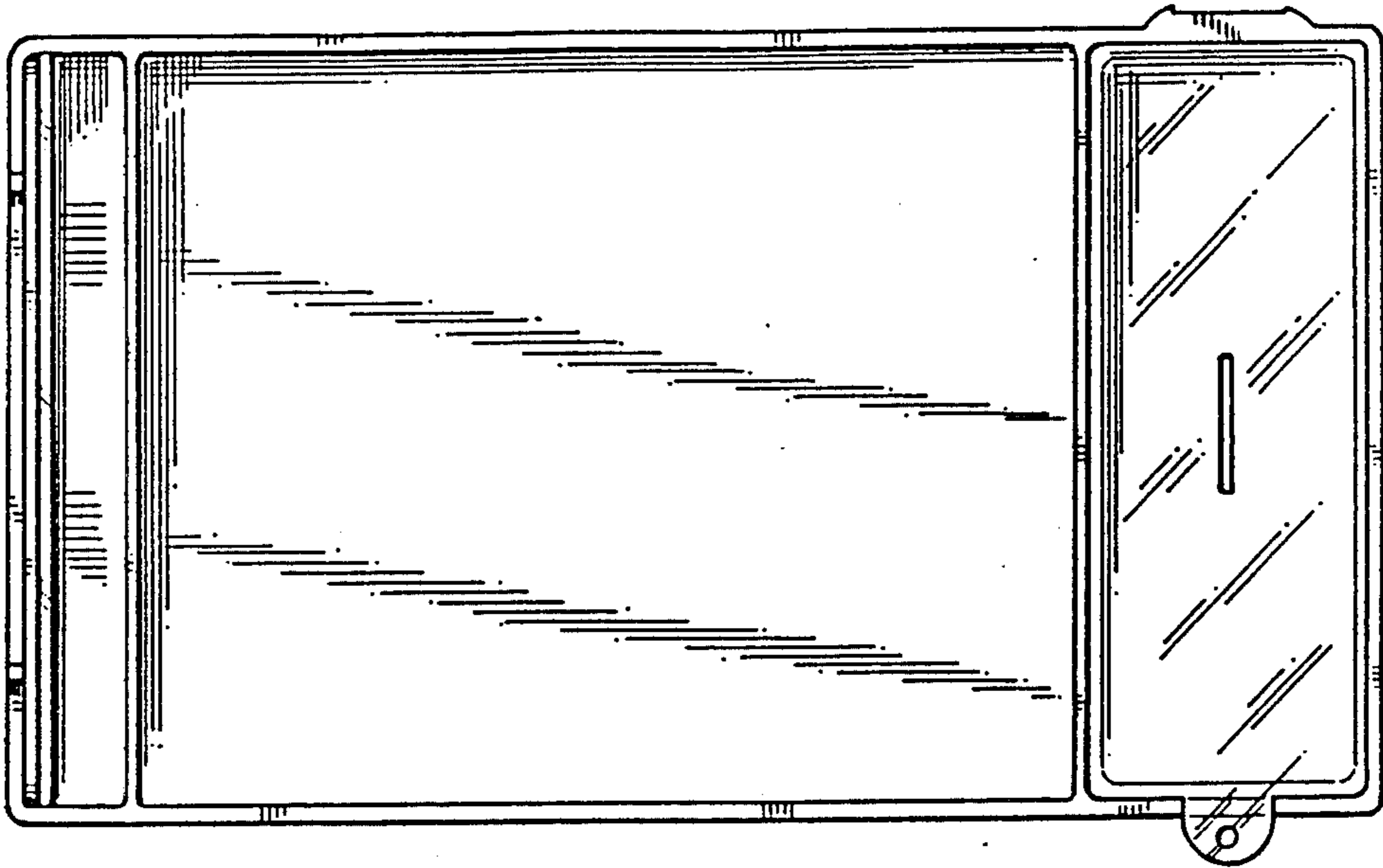

FIG-3

FIG-4

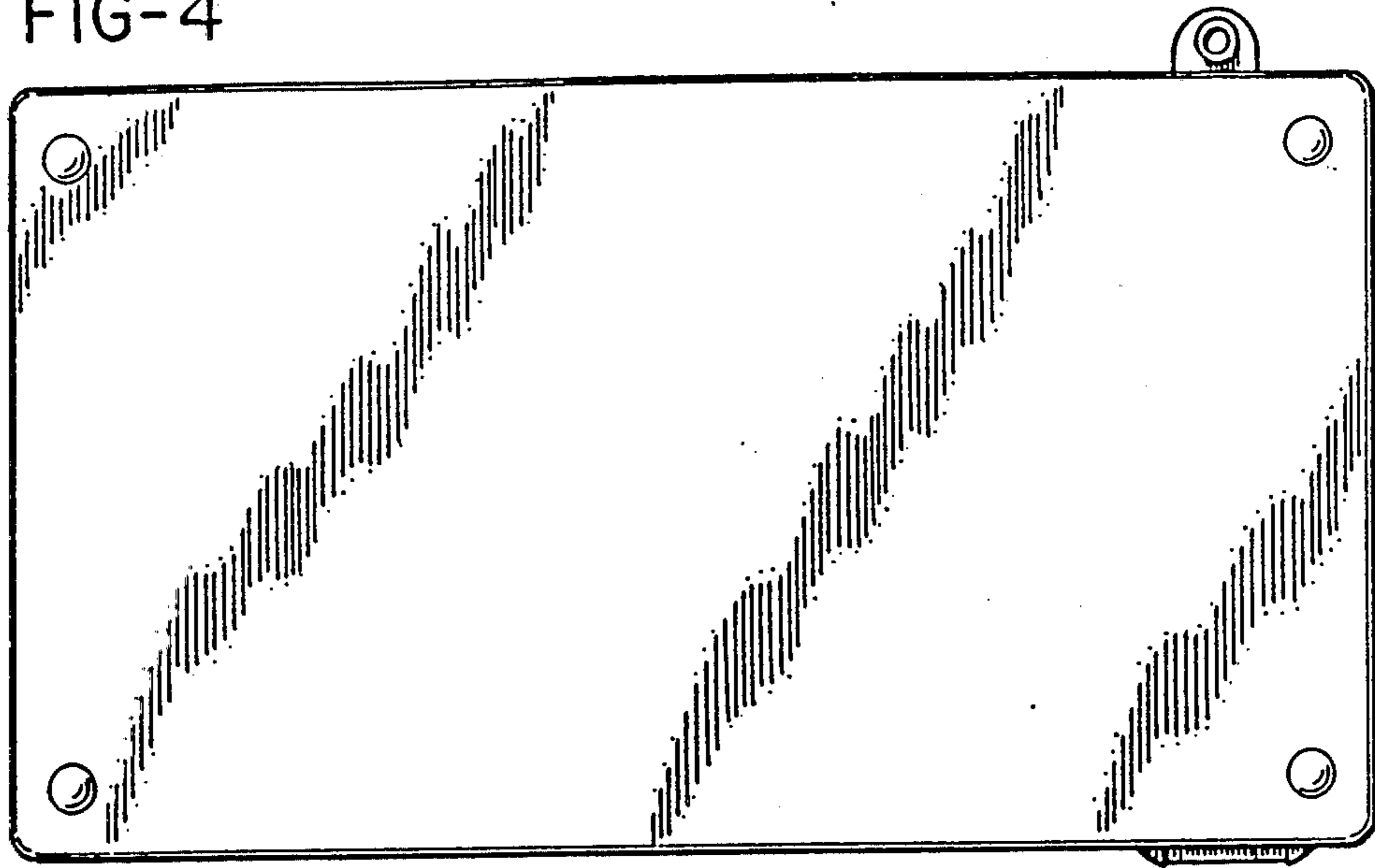

FIG-5

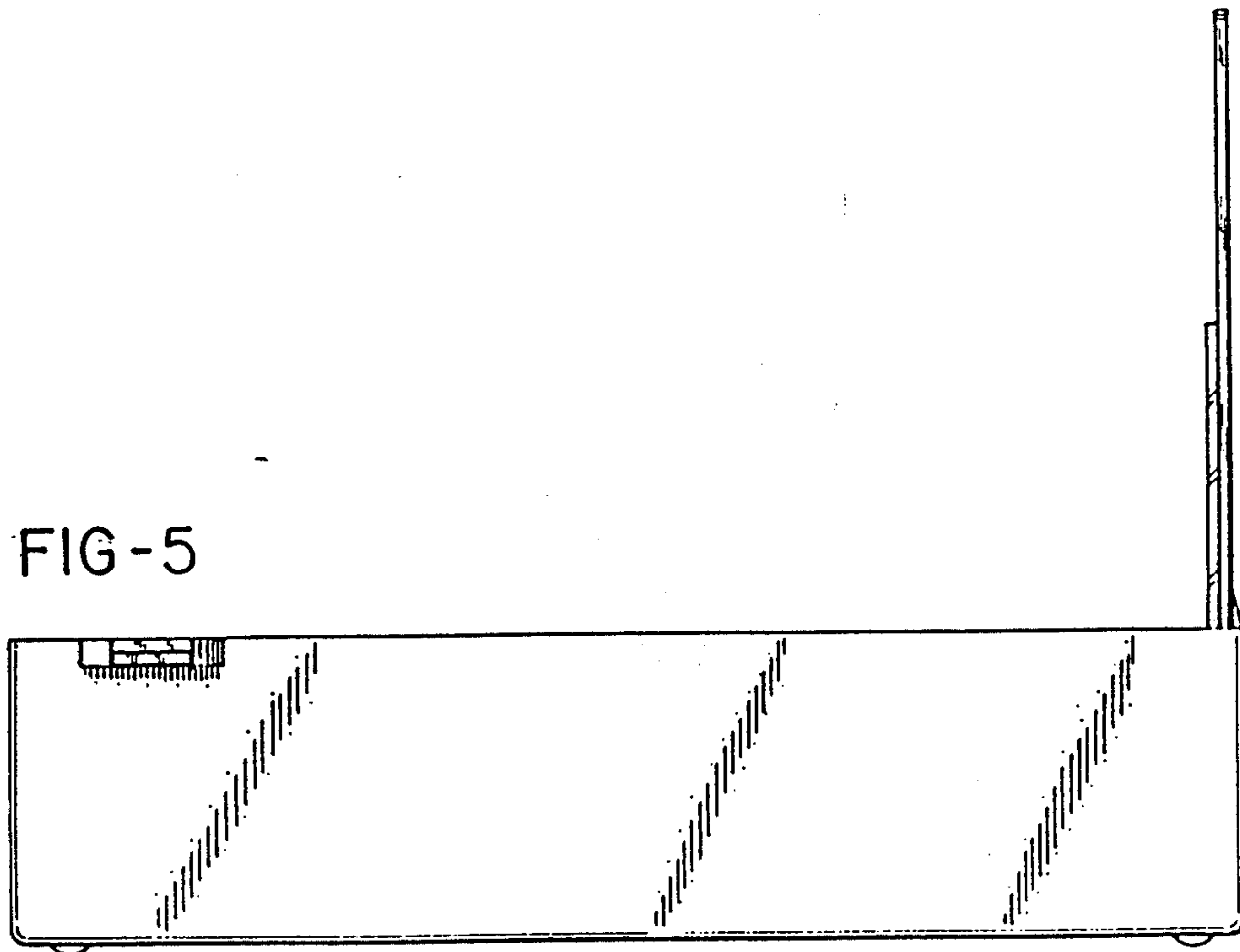

FIG-6

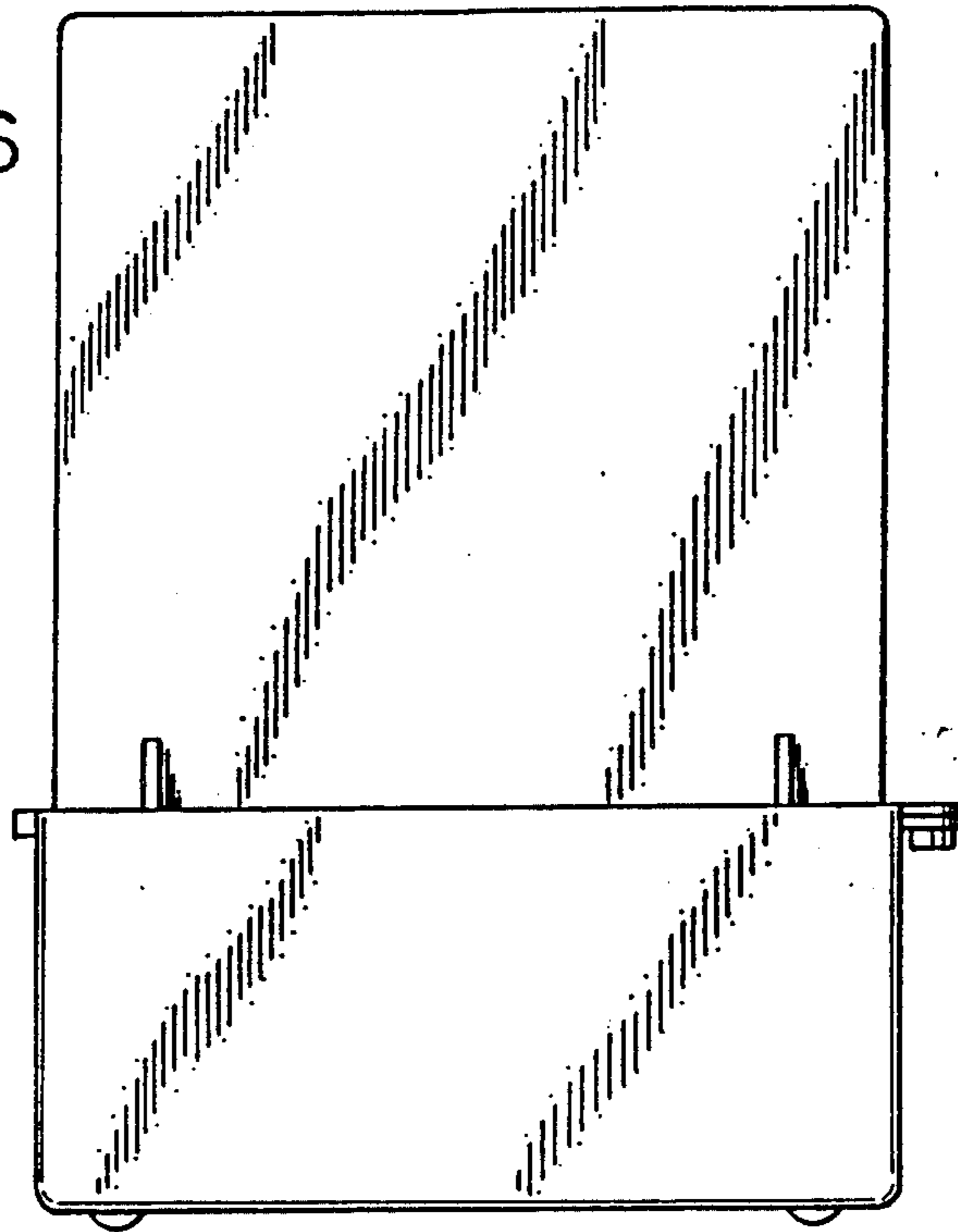
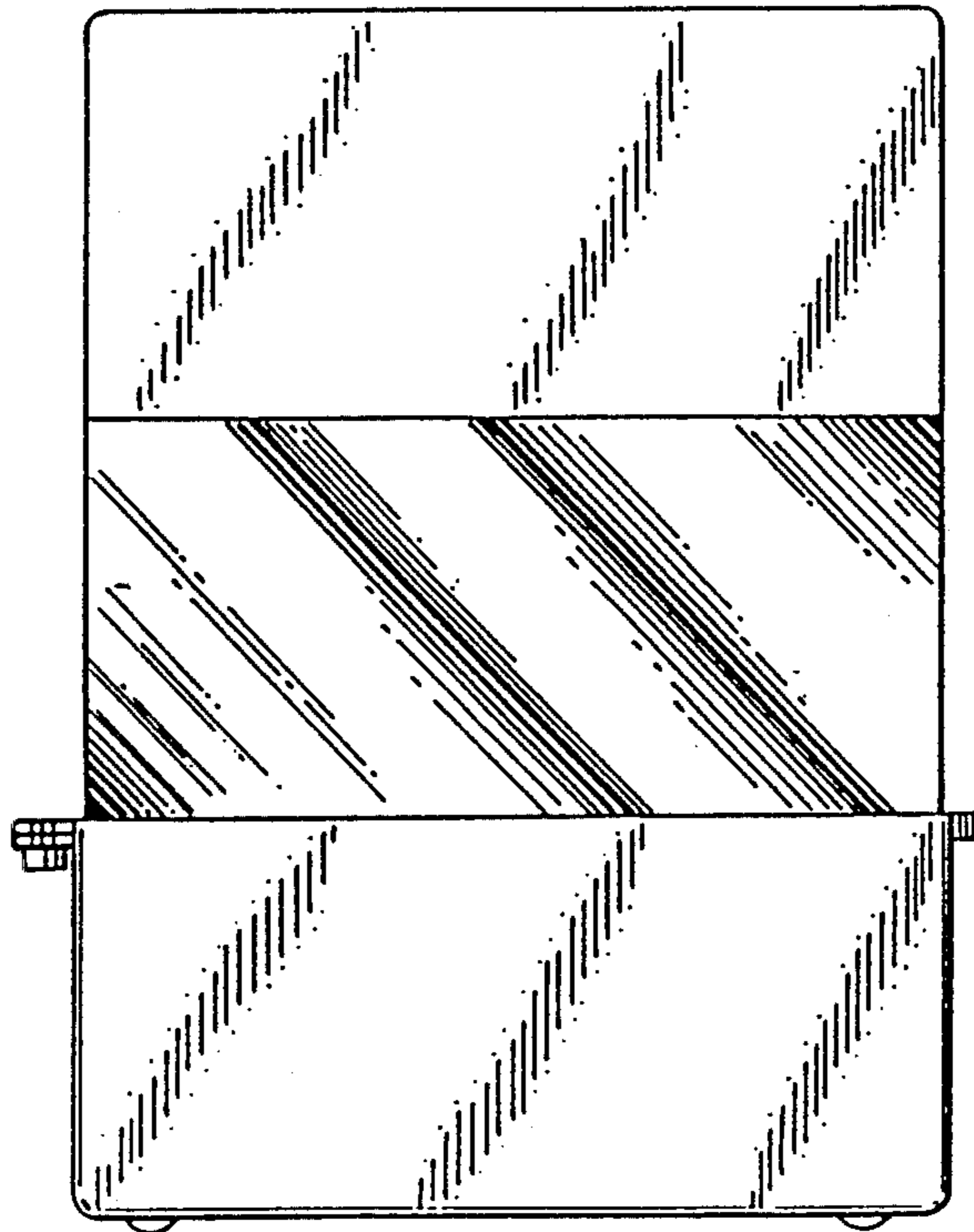

FIG-7



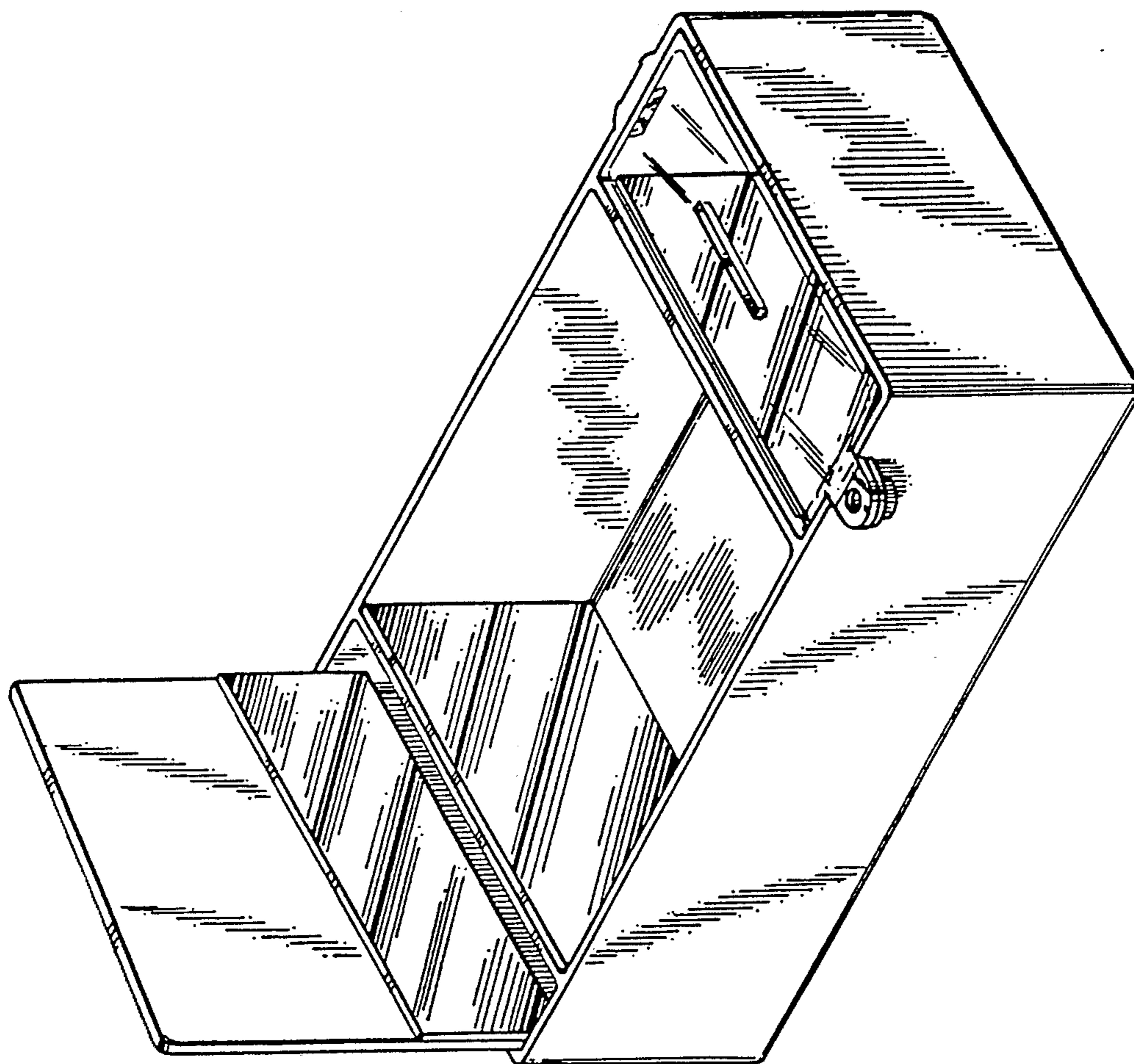

FIG-8

FIG-9

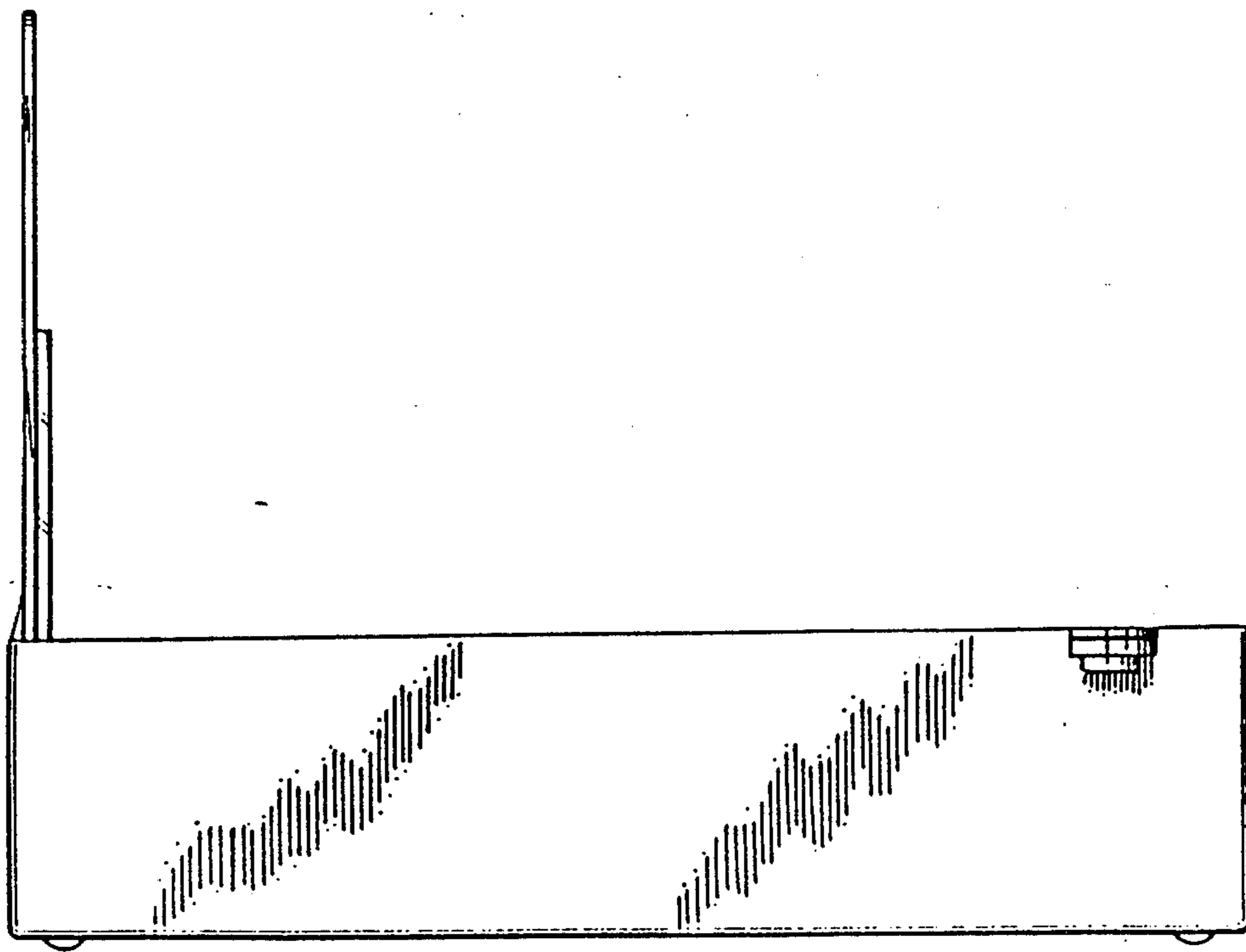
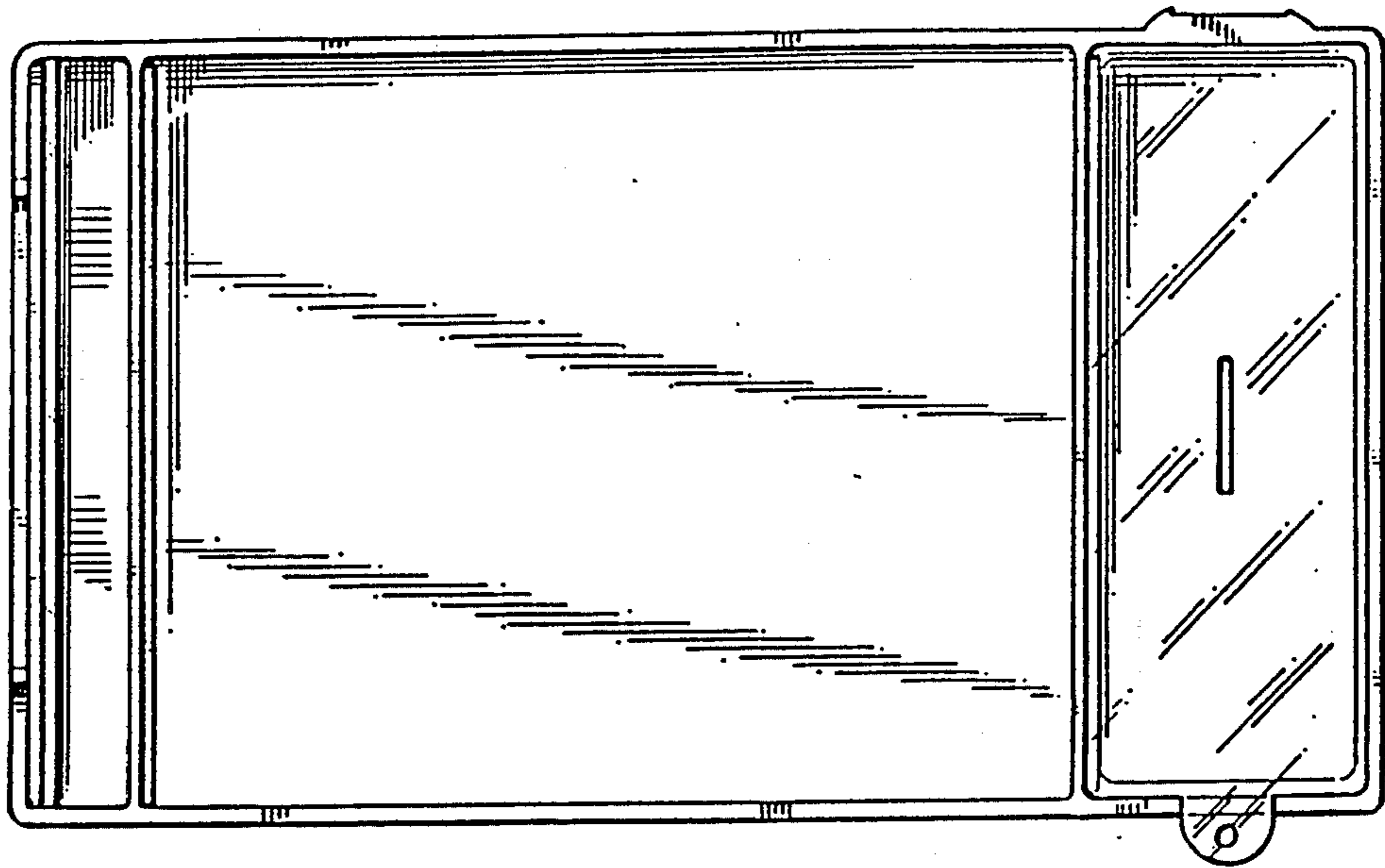

FIG-10

FIG-11

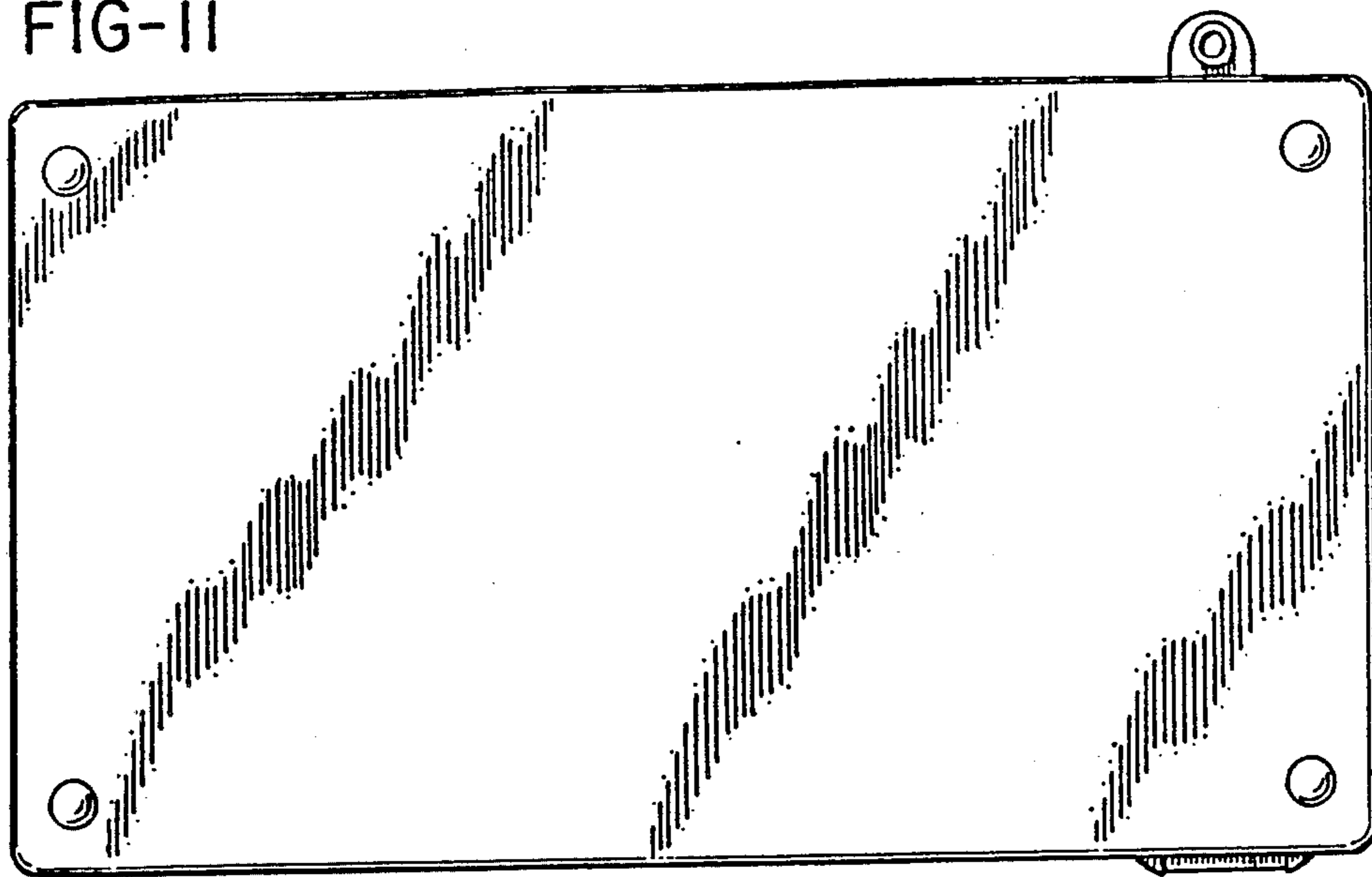

FIG-12

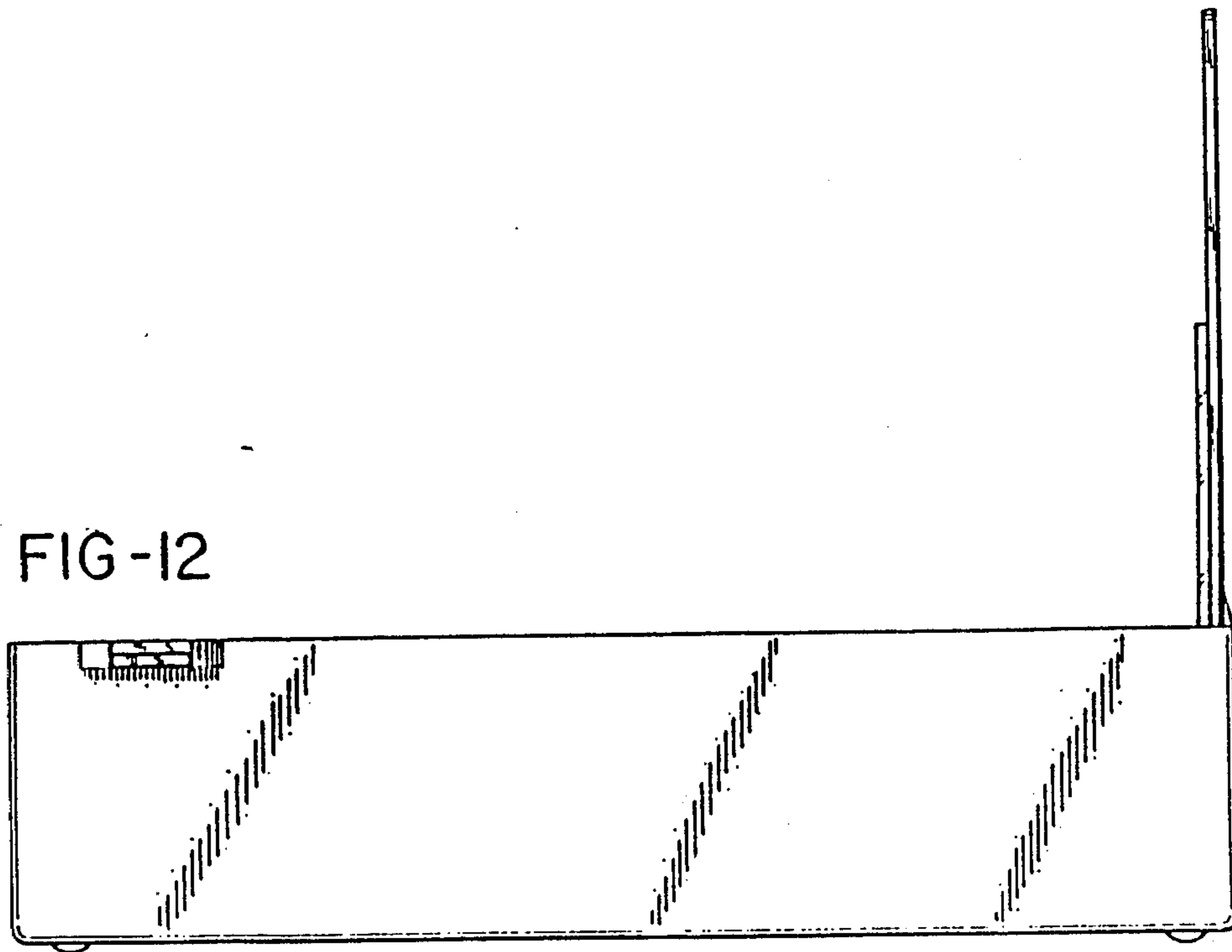

FIG-13

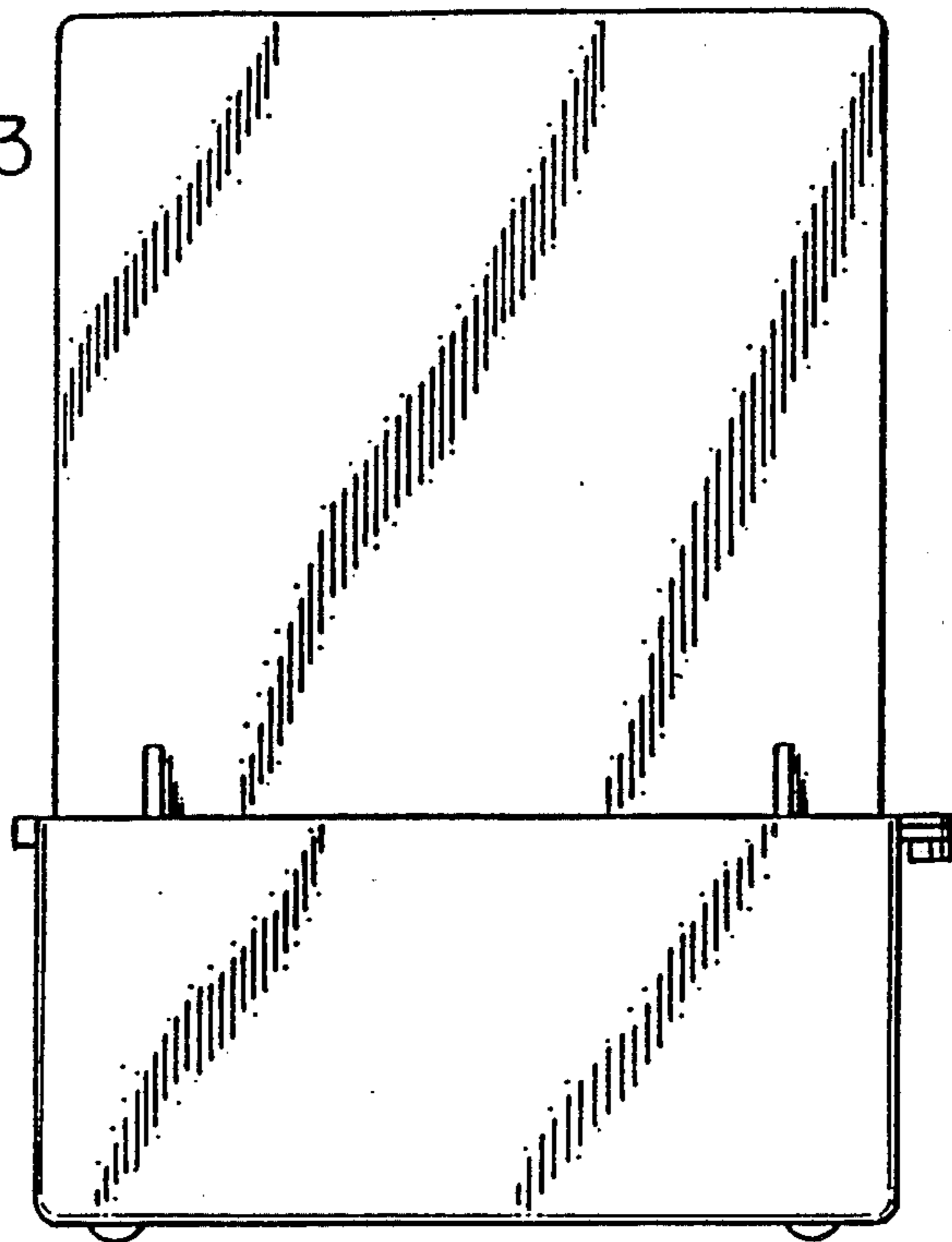

FIG-14

