

[54] CLOTHING HANGER BRACKET FOR AUTOMOBILES

D. 301,807 6/1989 Friedman ..... D6/323  
2,587,111 2/1952 Cashen, Jr. .... 211/1.3  
2,734,639 2/1956 Green ..... 248/215

[76] Inventor: Michael T. White, 833 W. 57th Ter., Kansas City, Mo. 64123

Primary Examiner—B. J. Bullock  
Attorney, Agent, or Firm—Kokjer, Kircher, Bradley, Wharton, Bowman & Johnson

[\*\*] Term: 14 Years

[21] Appl. No.: 115,095

[57] CLAIM

[22] Filed: Nov. 2, 1987

The ornamental design for a clothing hanger bracket for automobiles, as shown and described.

[52] U.S. Cl. .... D6/323; D6/327; D6/567

DESCRIPTION

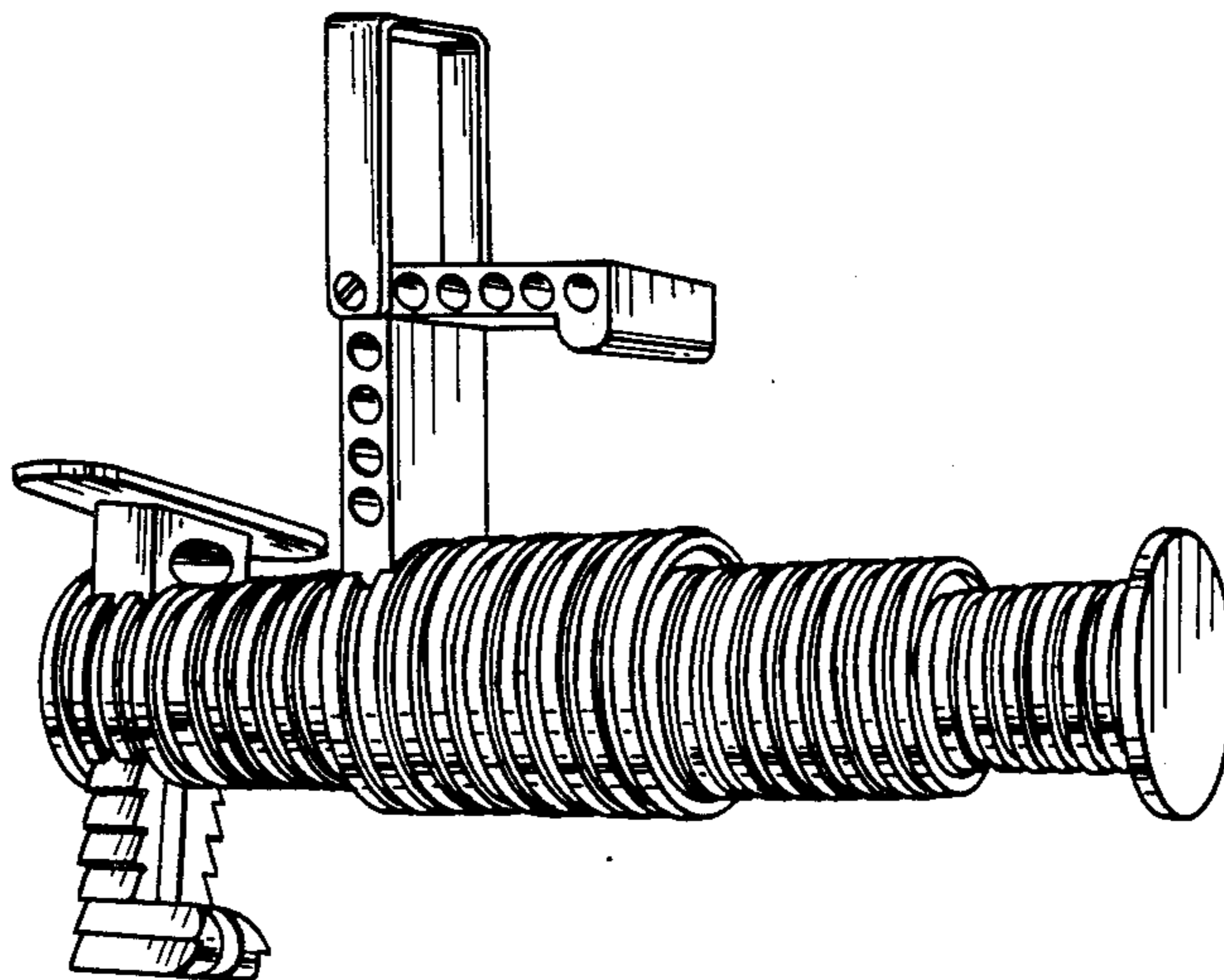
[58] Field of Search ..... D6/315, 320, 323, 567, D6/327; 248/214, 215, 309.1; 211/1.3, 105.3; 224/42.46 A

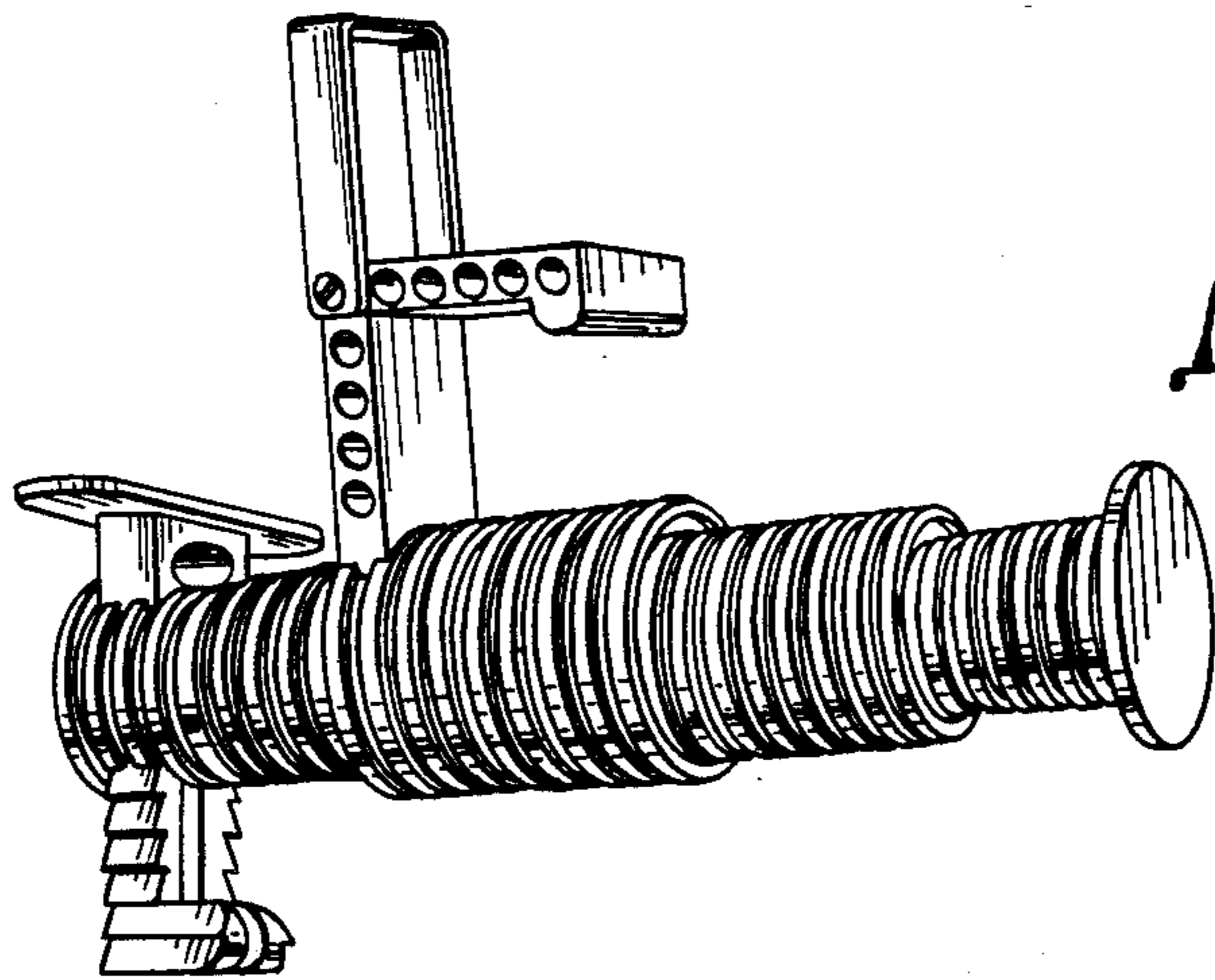
FIG. 1 is a perspective view of a clothing hanger bracket for automobiles showing our new design; FIG. 2 is a left side elevational view thereof, the side opposite being a mirror image; FIG. 3 is a front elevational view thereof; FIG. 4 is a rear elevational view thereof; FIG. 5 is a top plan view thereof; and FIG. 6 is a bottom plan view thereof.

[56] References Cited

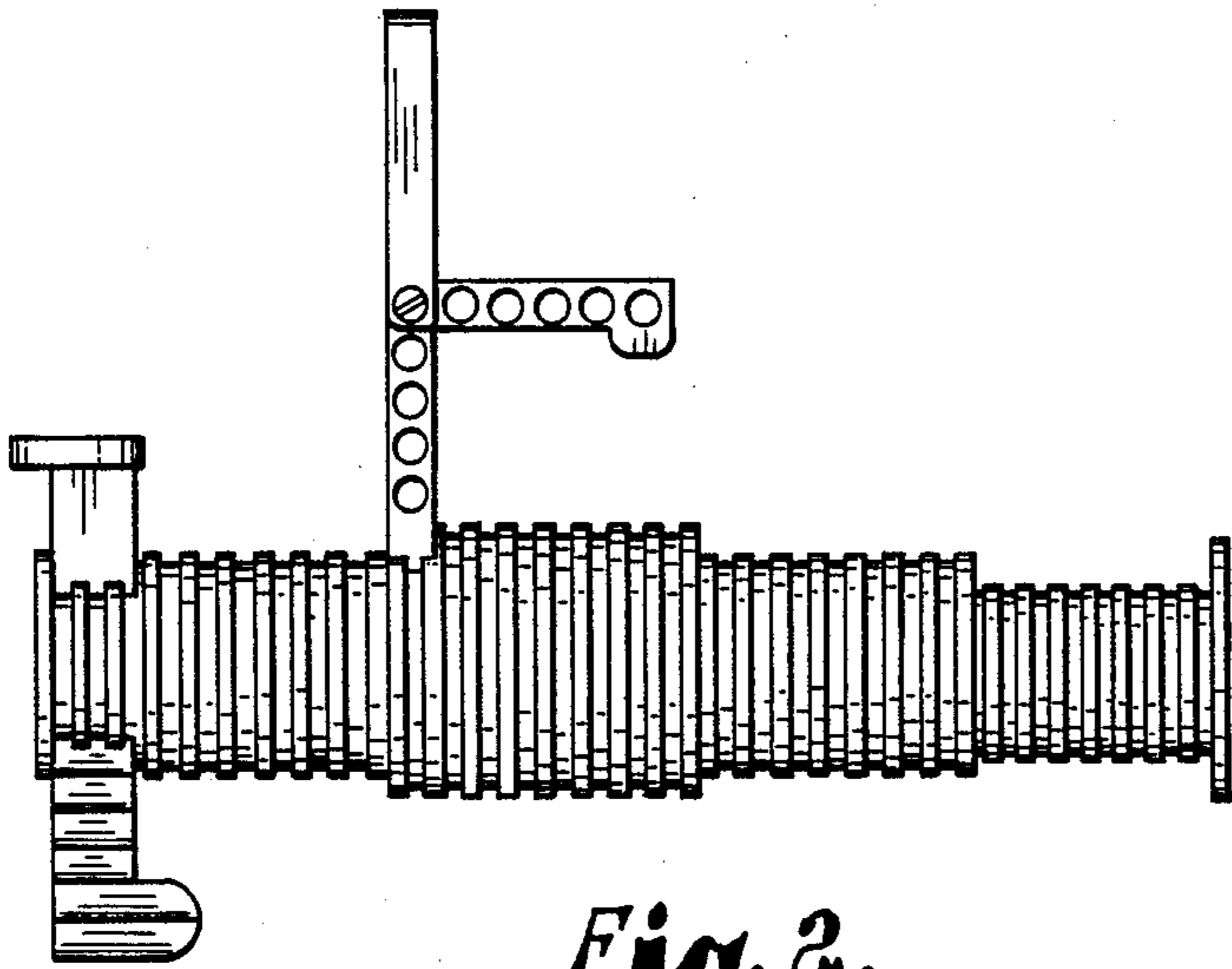
U.S. PATENT DOCUMENTS

D. 251,165 2/1979 Moody ..... D6/317  
D. 251,463 4/1979 Cangelosi ..... D6/317

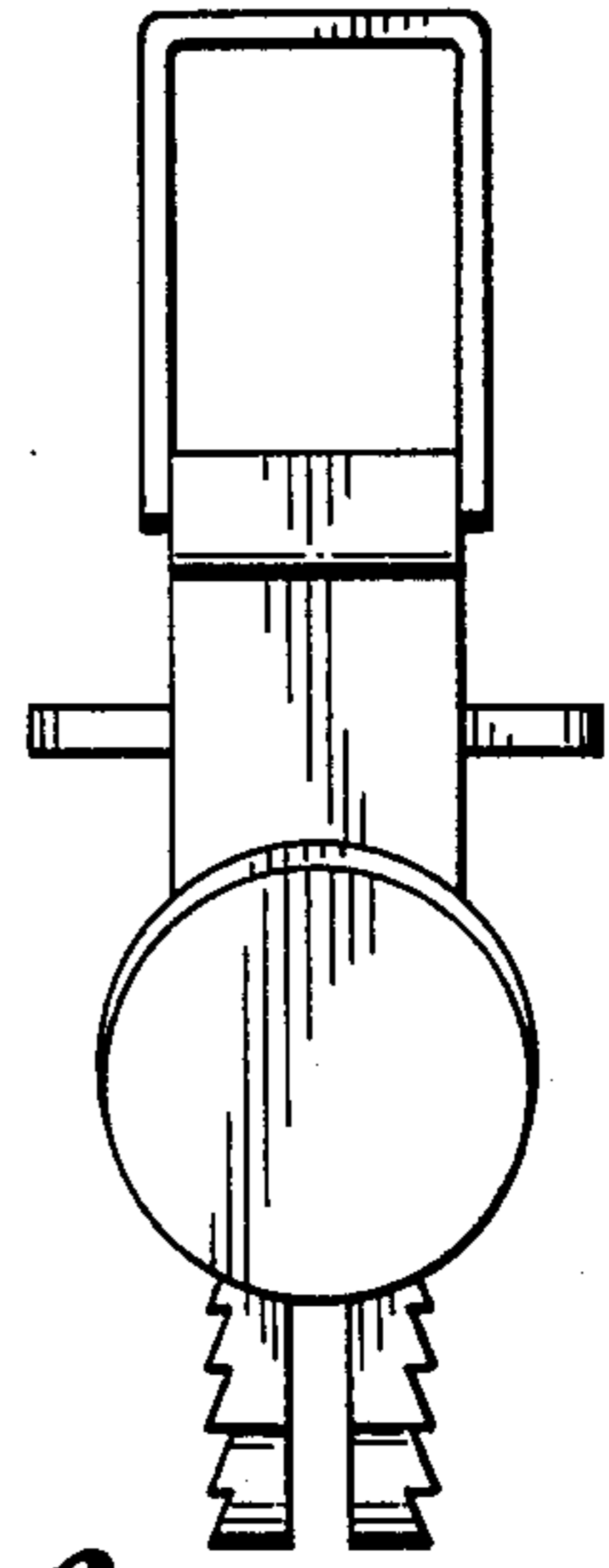




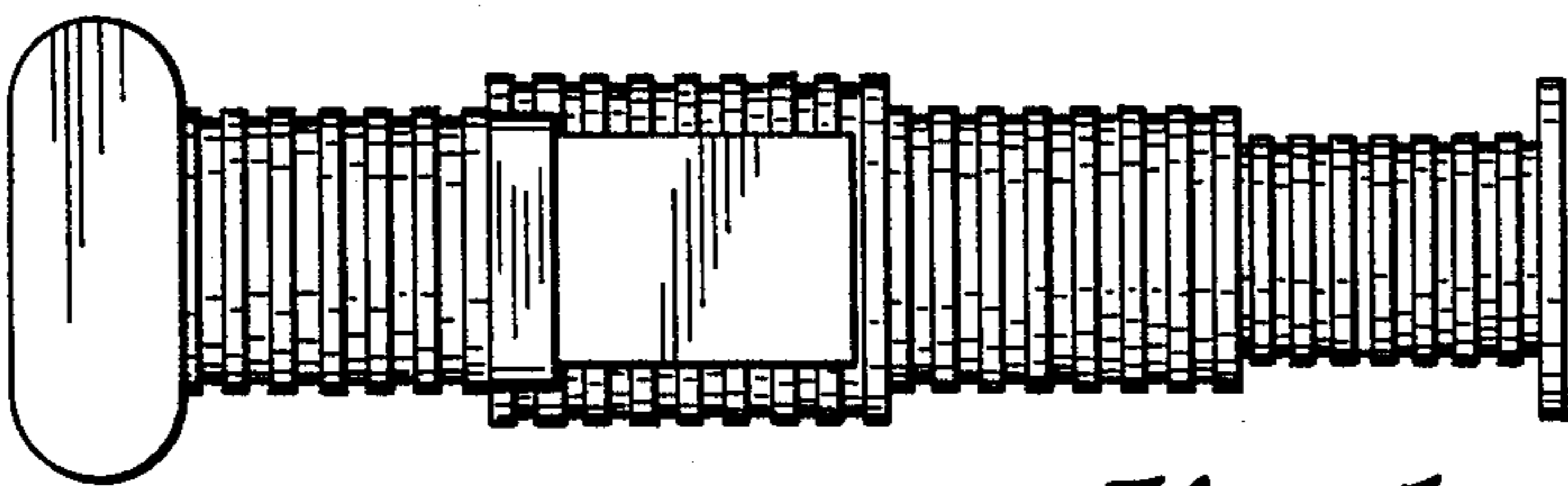
*Fig. 1.*



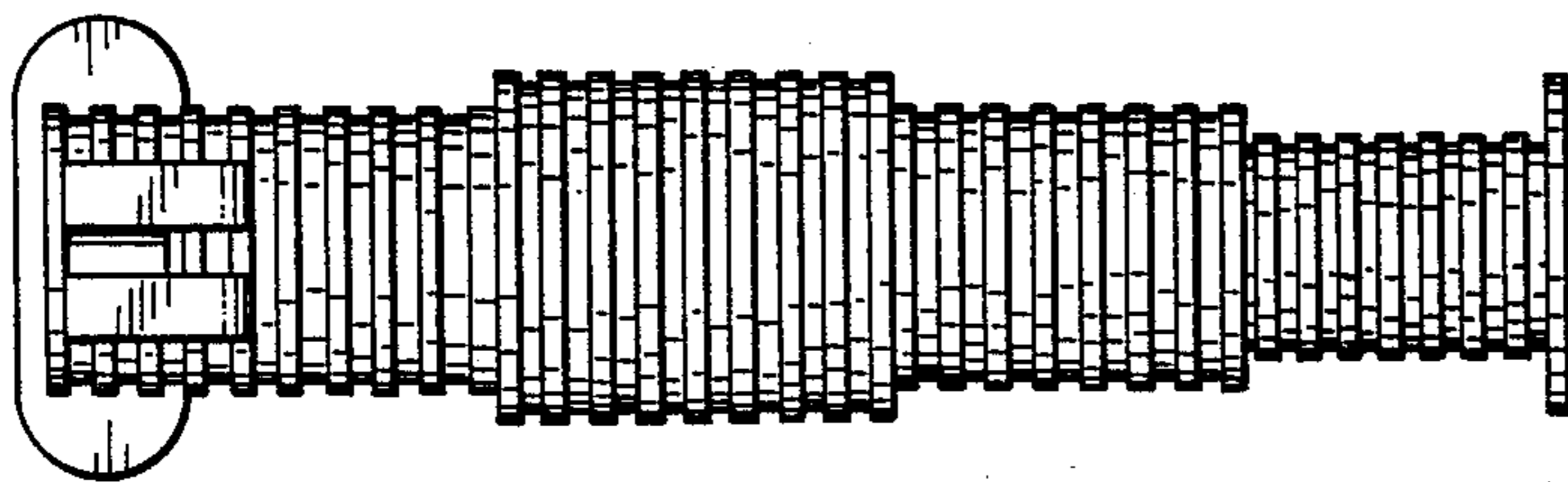
*Fig. 2.*



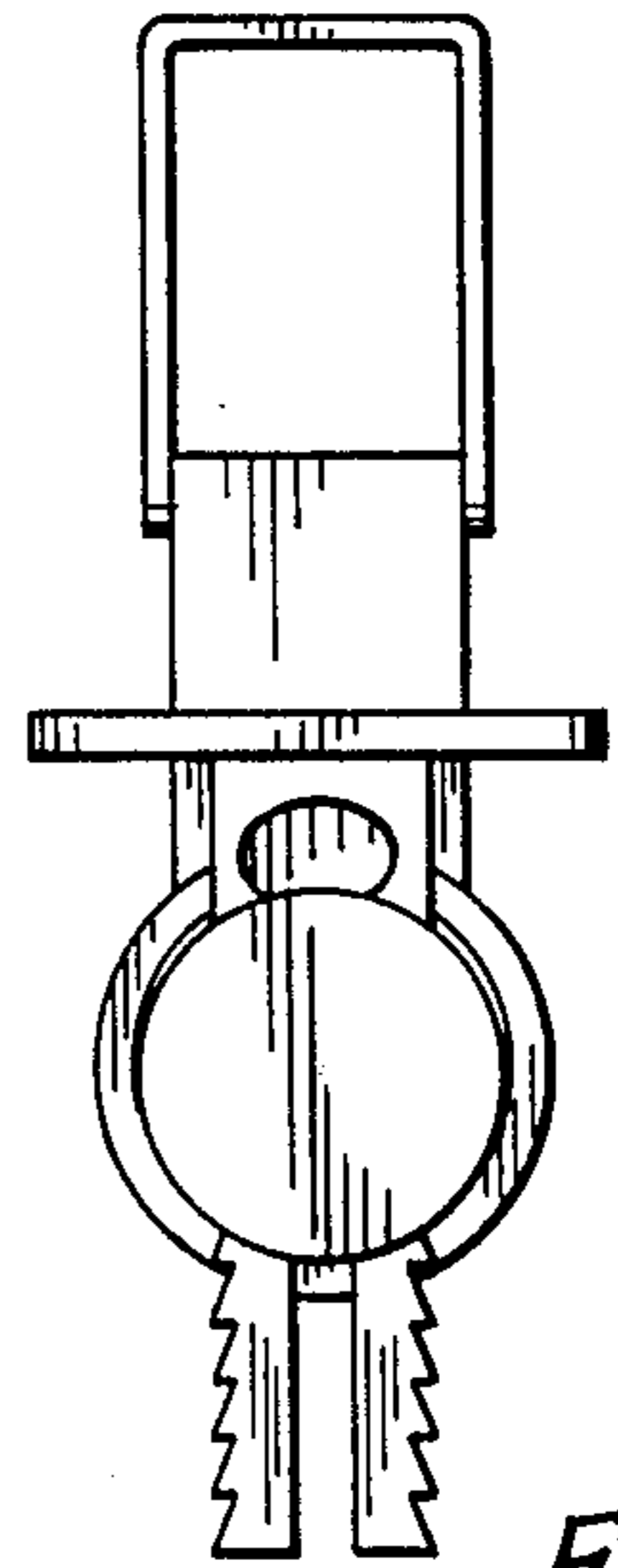
*Fig. 3.*



*Fig. 5.*



*Fig. 6.*



*Fig. 4.*