

[54] **INVERTED BOTTLE HOLDER**

[76] Inventor: **Jason Freidenfelds**, 26 Stafford St.,
Madison, N.J. 07940

[**] Term: **14 Years**

[21] Appl. No.: **209,784**

[22] Filed: **Jun. 22, 1988**

[52] U.S. Cl. **D7/619**

[58] Field of Search **D7/70; D8/33, 40;**
141/319; 220/85 H; 81/3.4, 3.43; D9/447, 449,
450, 434, 455

[56] **References Cited**

U.S. PATENT DOCUMENTS

D. 273,942	5/1984	Bizueck et al.	D9/434
D. 287,093	12/1986	Ryan	D8/40 X
2,767,744	10/1956	Beerman	D7/70 X

Primary Examiner—Bernard Ansher
Assistant Examiner—Terry A. Pfeffer
Attorney, Agent, or Firm—Mathews, Woodbridge,
Goebel, Pugh & Collins

[57] **CLAIM**

The ornamental design for a receptacle for inverted bottle holder, as shown and described.

DESCRIPTION

FIG. 1 is a top perspective view of an inverted bottle holder showing my new design;
FIG. 2 is a top plan view thereof;
FIG. 3 is a right side elevational view thereof, the opposite side being a mirror image;
FIG. 4 is a front elevational view thereof, the opposite side being a mirror image;
FIG. 5 is a bottom perspective view thereof.
The bottle is shown in broken lines for illustrative purposes only.

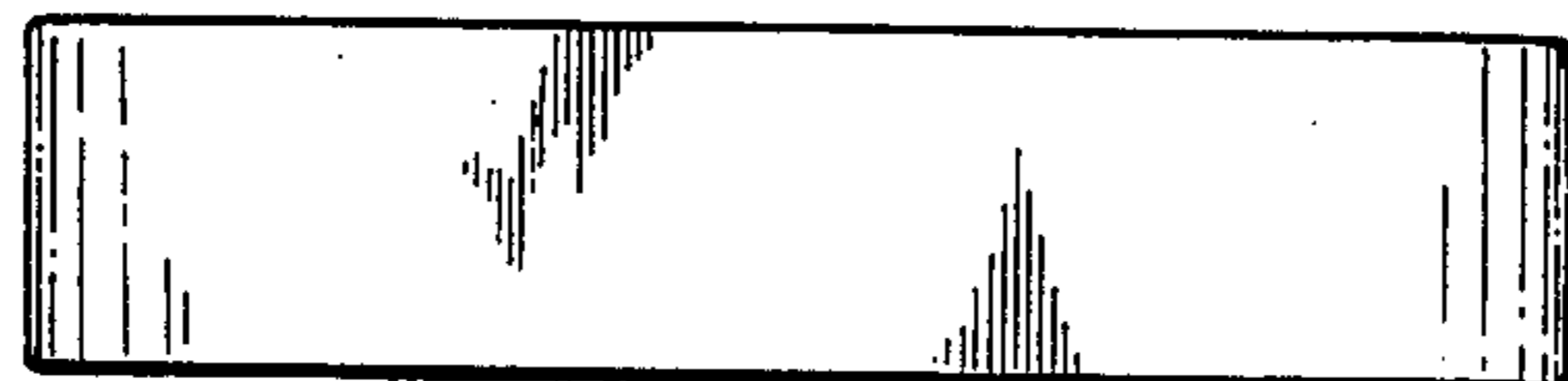
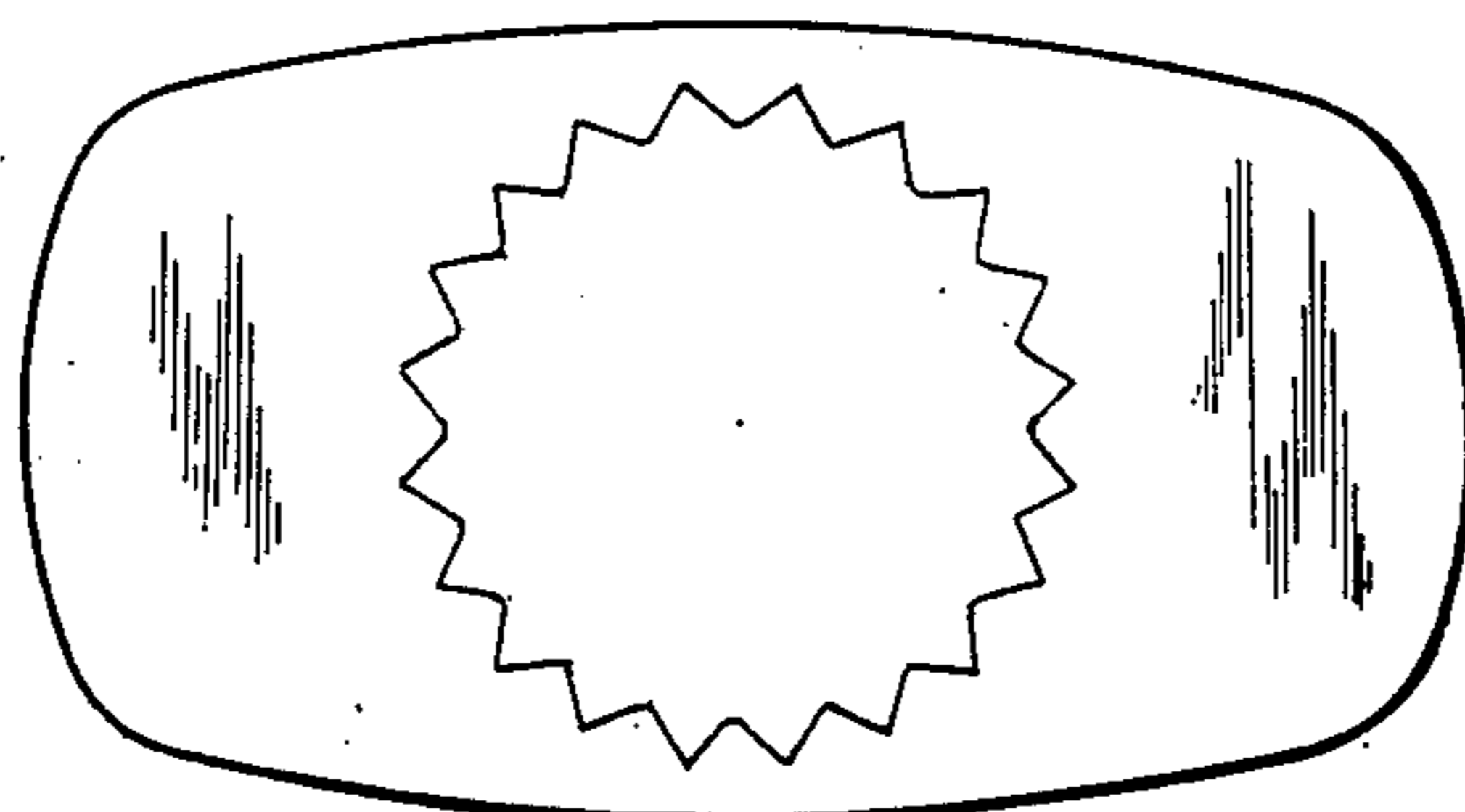

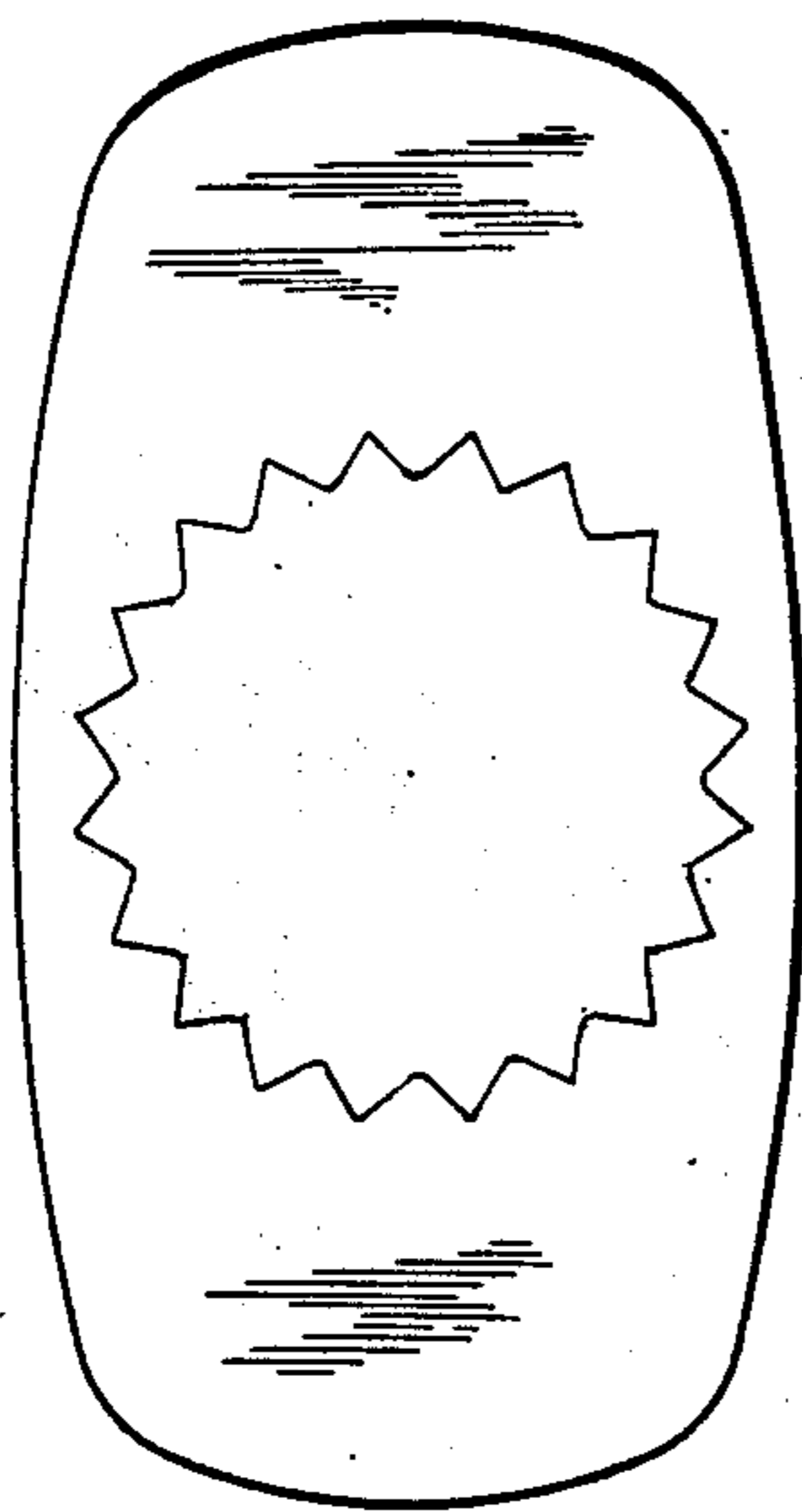

FIG. 2

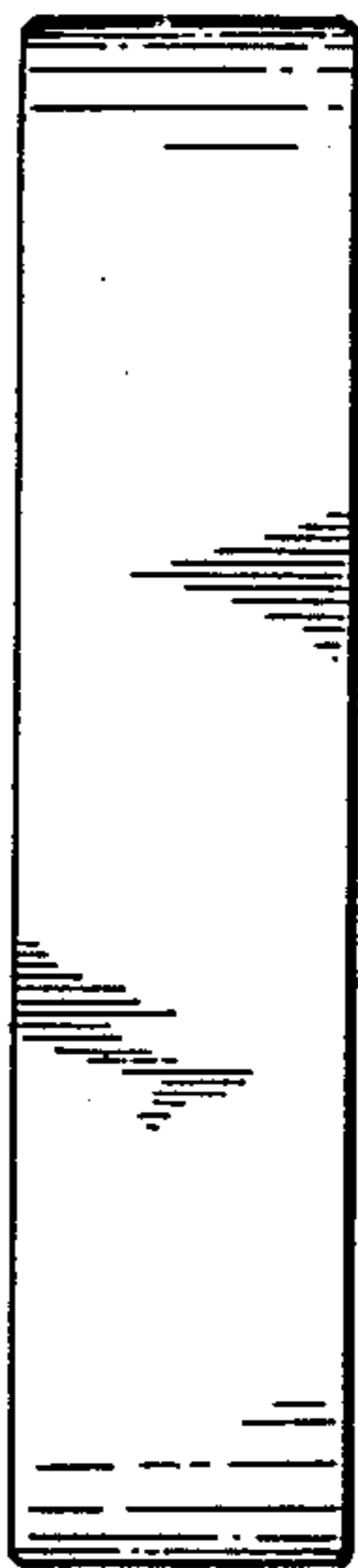

FIG. 3

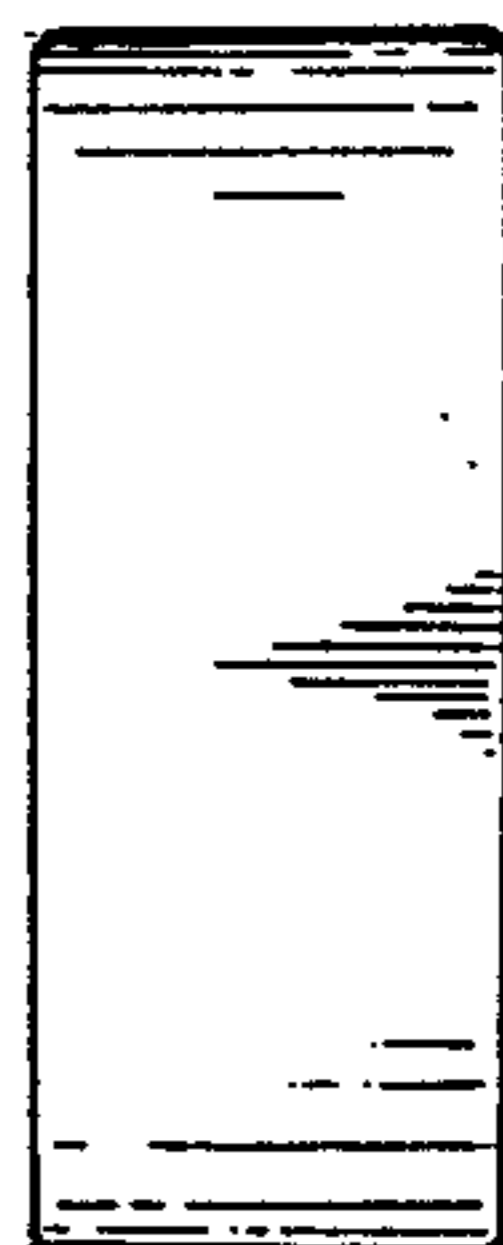

FIG. 4

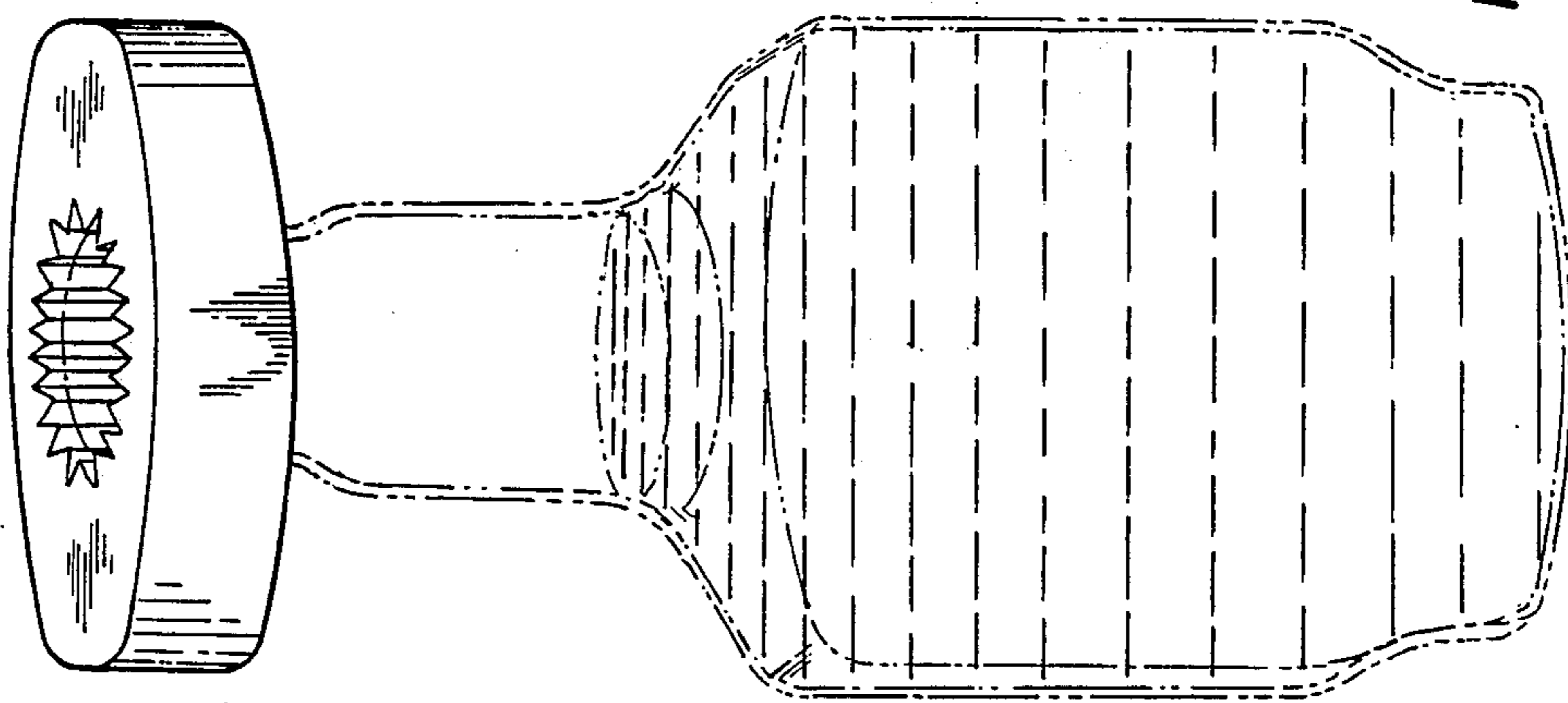

FIG. 1

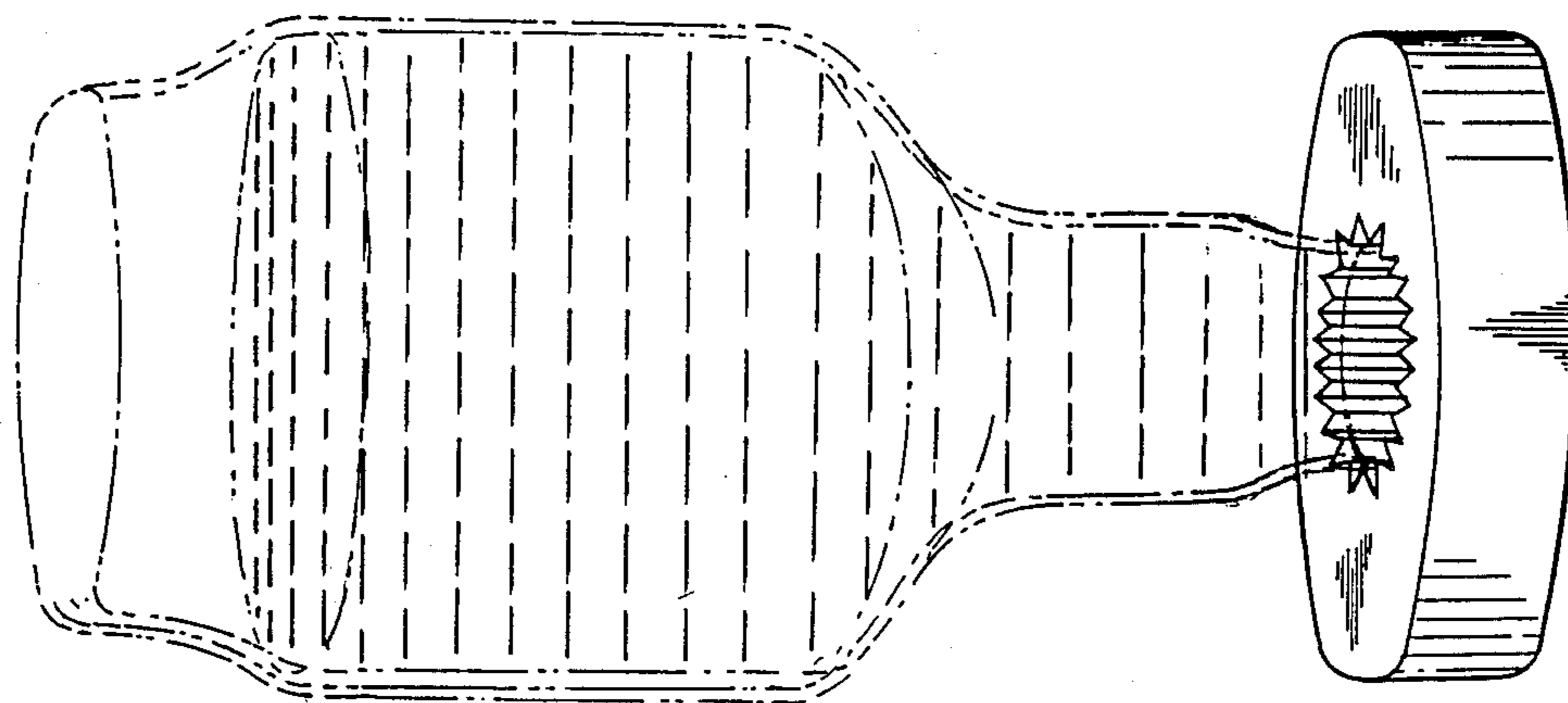

FIG. 5