

[54] **COMBINED COSMETIC COMPACT AND APPLICATOR**

[75] **Inventor: Karena Bakic, Varese, Italy**

[73] **Assignee: Cosmede Anstalt, Vaduz, Liechtenstein**

[**] **Term: 14 Years**

[21] **Appl. No.: 11,724**

[22] **Filed: Feb. 6, 1987**

[30] **Foreign Application Priority Data**

Aug. 7, 1986 [DE] Fed. Rep. of Germany URA
1051/86
Dec. 2, 1986 [DE] Fed. Rep. of Germany URA
1588/86
Feb. 2, 1987 [DE] Fed. Rep. of Germany URA
114/87

[52] **U.S. Cl. D28/7**

[58] **Field of Search D28/7, 4, 78; 401/126, 401/118**

[56] **References Cited**

U.S. PATENT DOCUMENTS

D. 238,972 2/1976 Greene D28/7
D. 268,618 4/1983 Napolitane D28/78
D. 283,453 4/1986 Hurrell D28/76
4,600,328 7/1986 Clements 401/118

FOREIGN PATENT DOCUMENTS

2103083 2/1983 United Kingdom 401/126

Primary Examiner—Bernard Ansher
Assistant Examiner—David Jeo

Attorney, Agent, or Firm—Kenyon & Kenyon

[57] **CLAIM**

The ornamental design for a combined cosmetic compact and applicator, as shown and described.

DESCRIPTION

FIG. 1 is a top front perspective view of a combined cosmetic compact and applicator showing my new design in a fully assembled condition;

FIG. 2 is a perspective view thereof, with the cover member in an open position;

FIG. 3 is a front elevational view of FIG. 1;

FIG. 4 is a bottom plan view thereof;

FIG. 5 is a side elevational view thereof;

FIG. 6 is a top plan view thereof;

FIG. 7 is a rear elevational view thereof;

FIG. 8 is a top front perspective view of a second modified embodiment of the cosmetic compact illustrated in FIG. 1;

FIG. 9 is a perspective view thereof, with the cover member in an open position;

FIG. 10 is a front elevational view thereof;

FIG. 11 is a side elevational view thereof;

FIG. 12 is a top plan view thereof;

FIG. 13 is a top front perspective view of a third modified embodiment of the cosmetic compact illustrated in FIG. 1;

FIG. 14 is a perspective view thereof, with the cover member in an open position;

FIG. 15 is a top front perspective view of a fourth modified embodiment of the cosmetic compact illustrated in FIG. 1; and

FIG. 16 is a perspective view thereof, with the cover member in an open position.

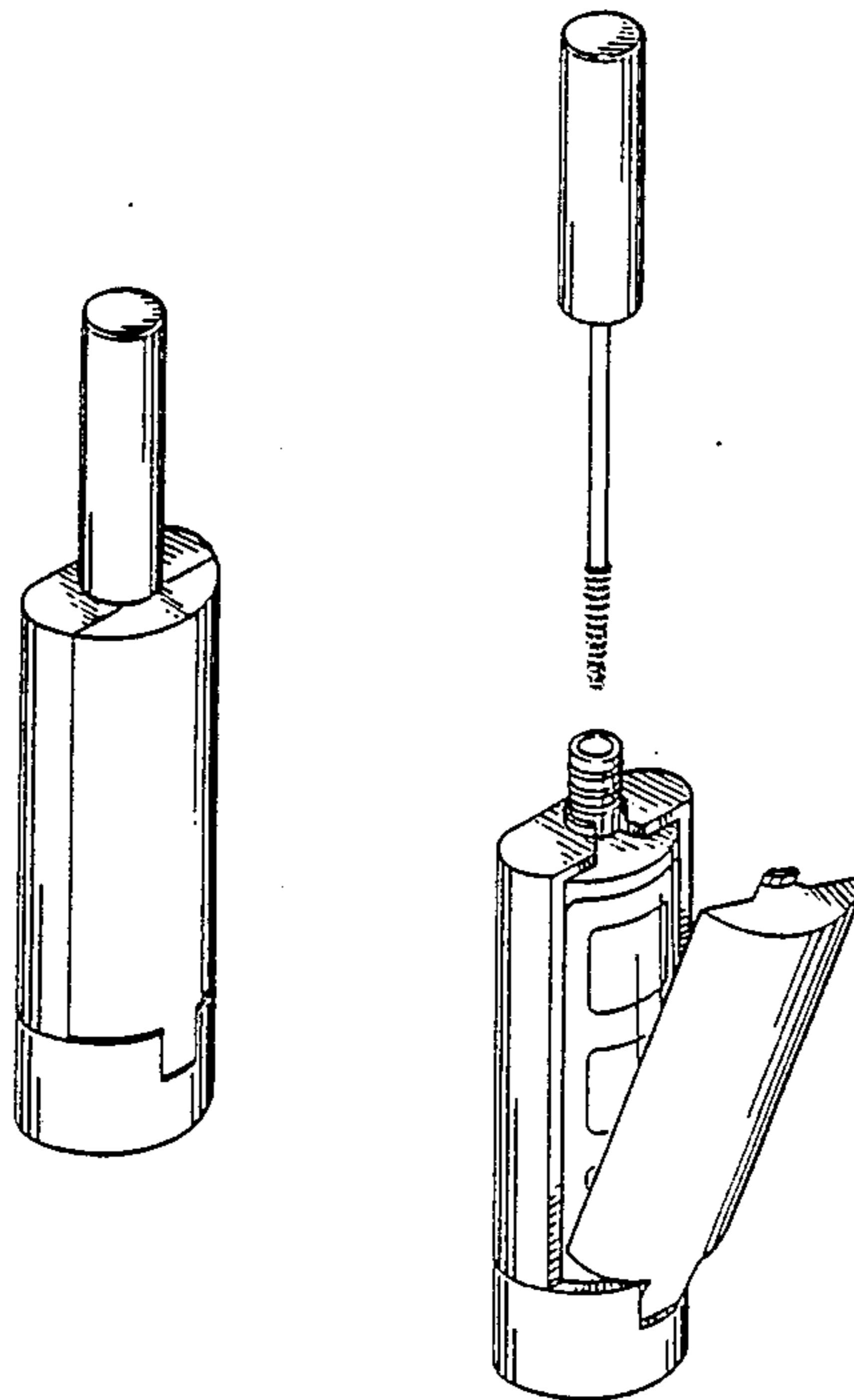

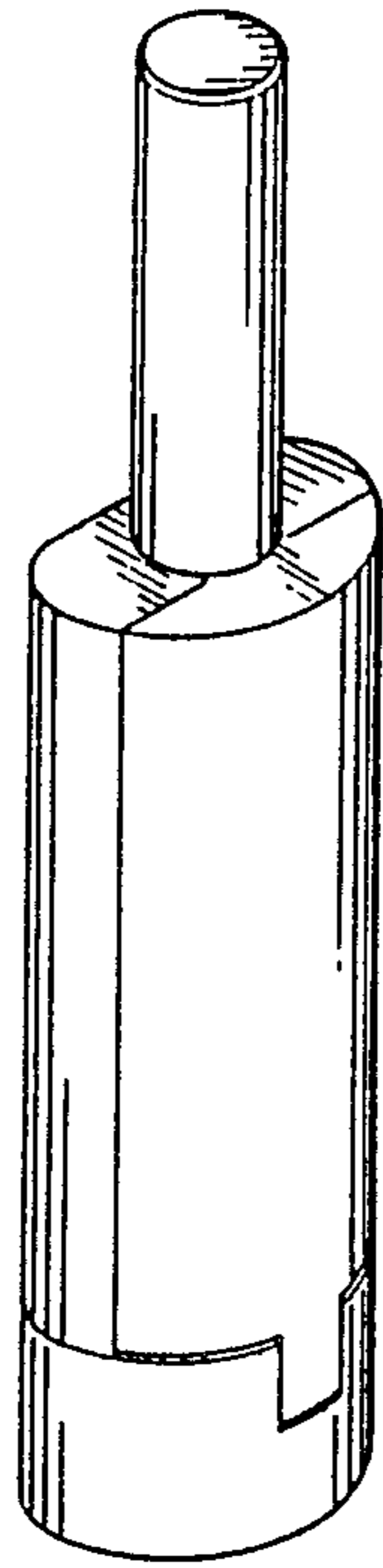

FIG. 1

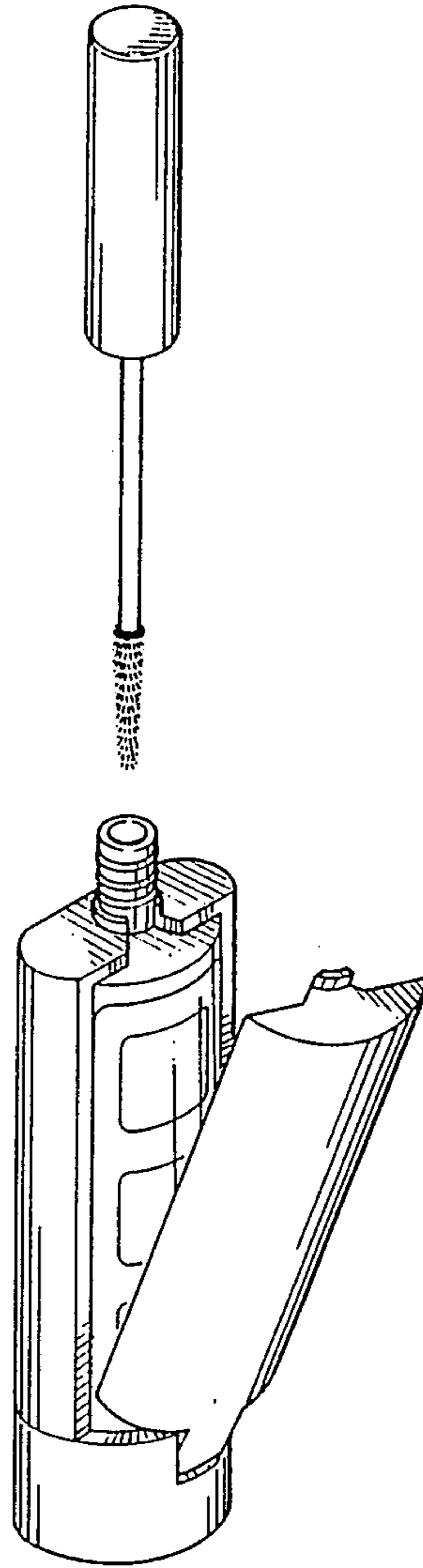

FIG. 2

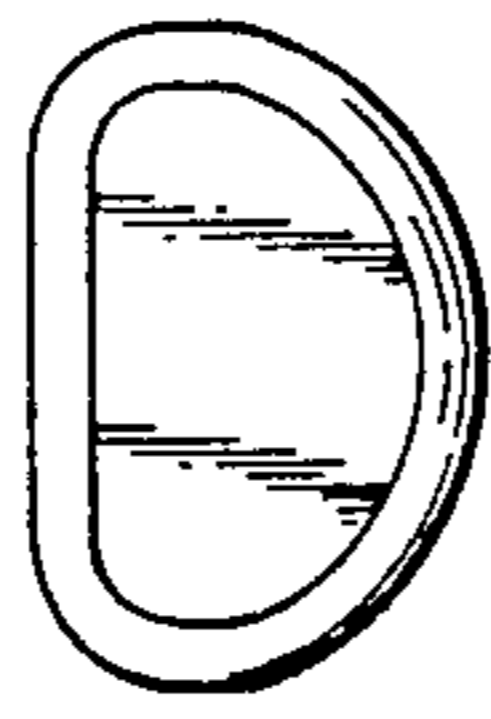

FIG. 4

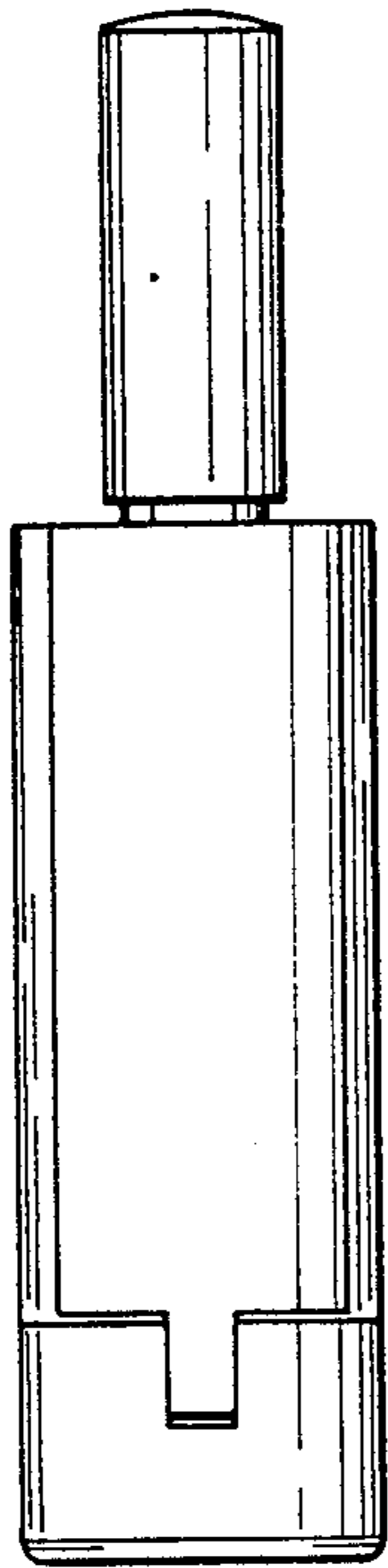

FIG. 3

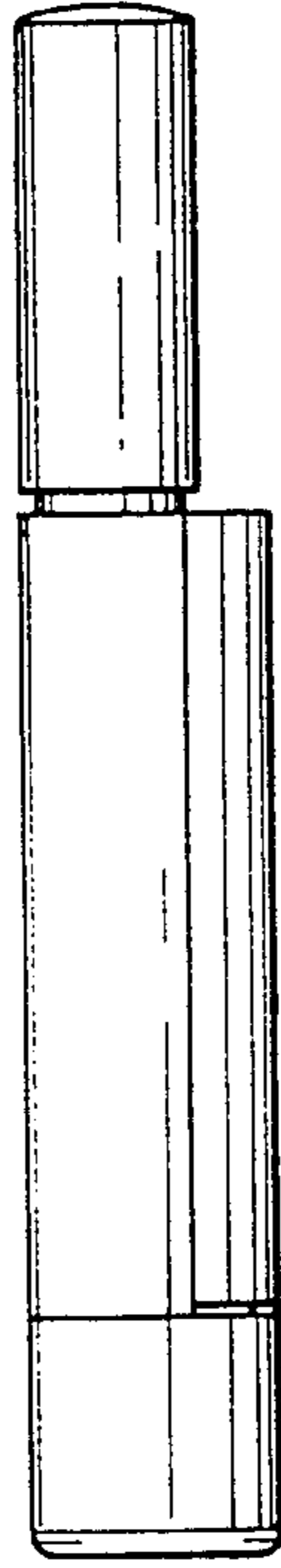

FIG. 5

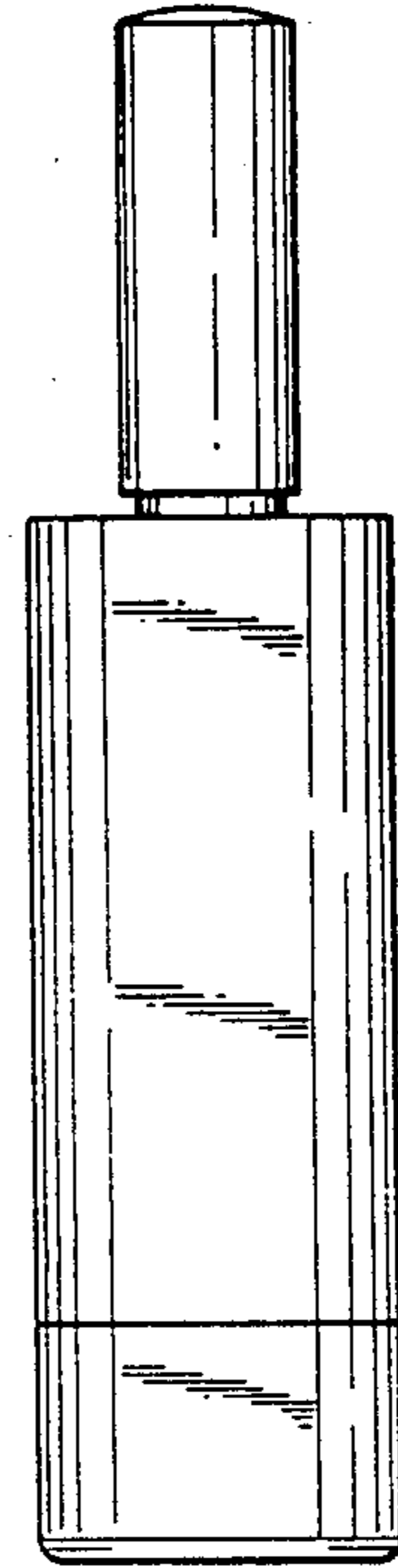

FIG. 7

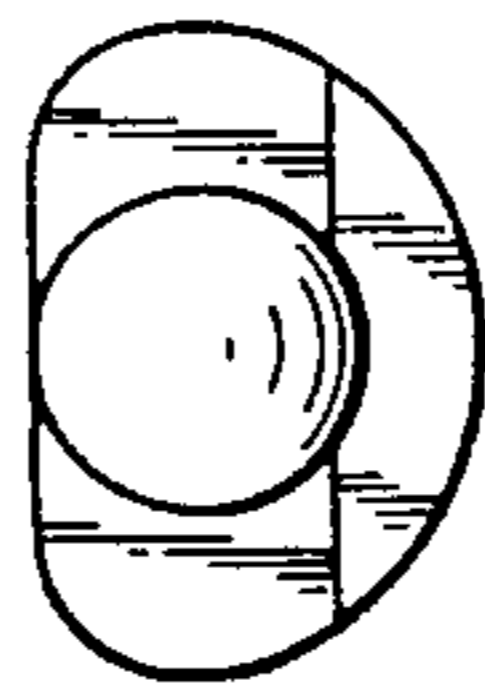

FIG. 6

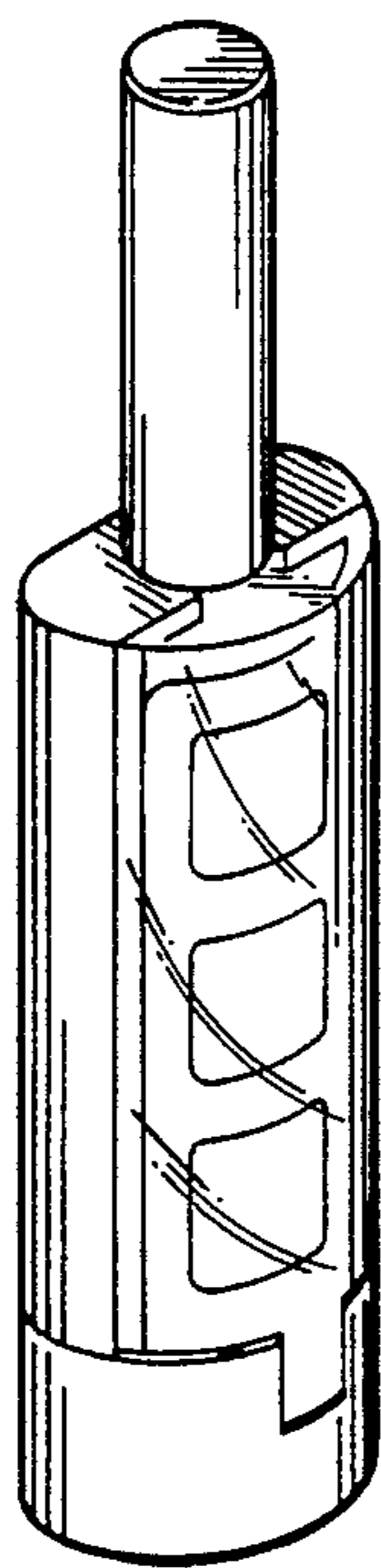

FIG. 8

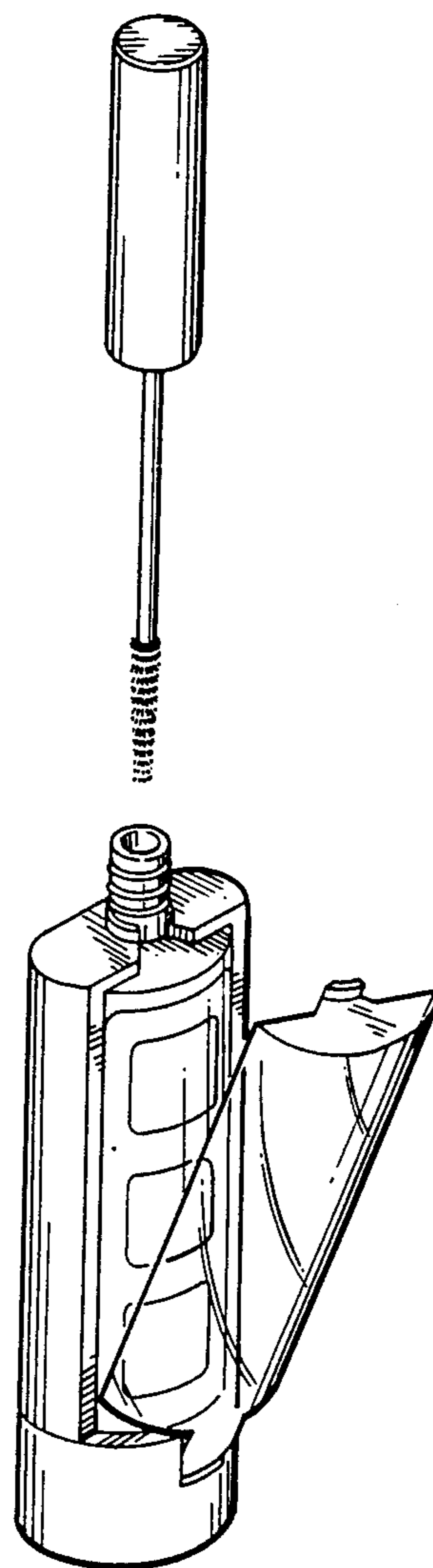

FIG. 9

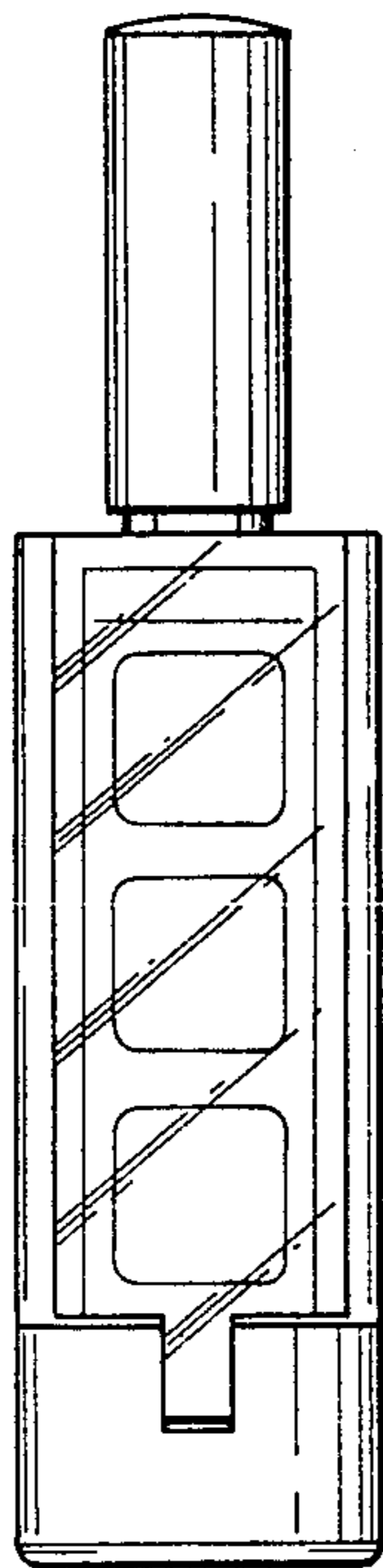

FIG. 10

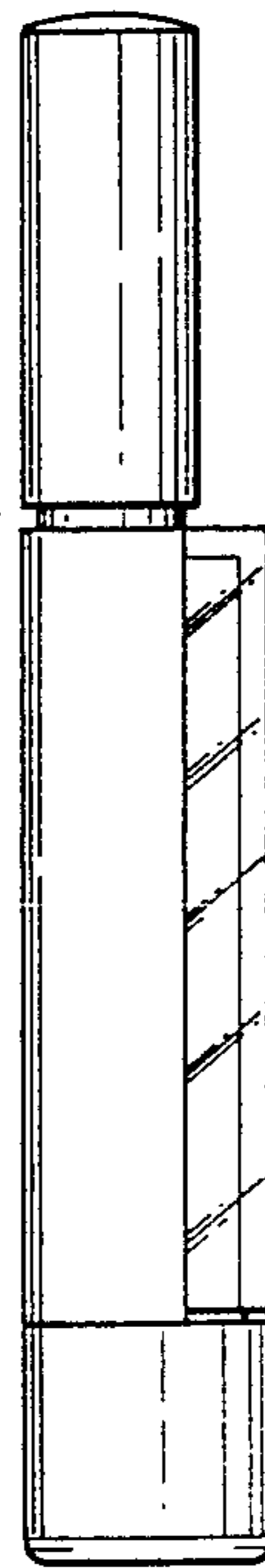

FIG. 11

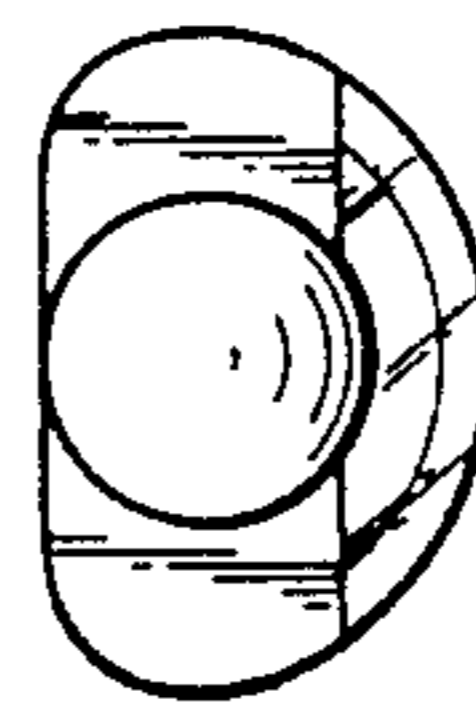

FIG. 12

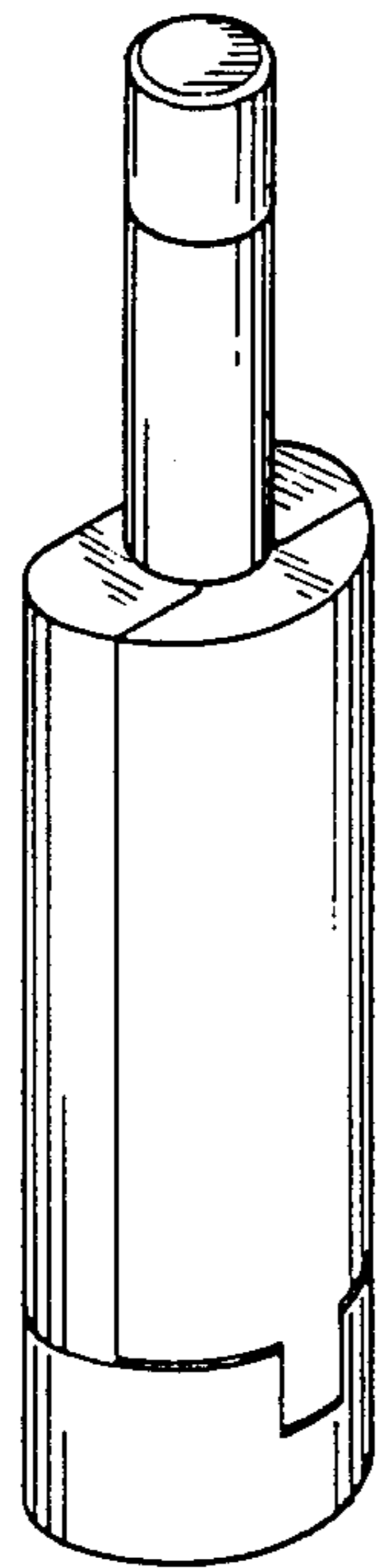

FIG. 13

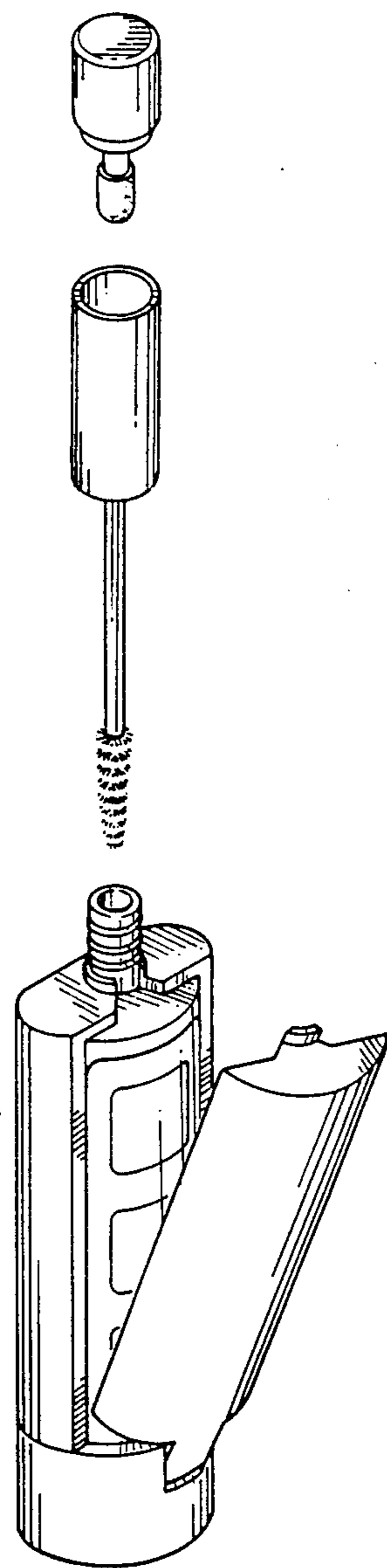

FIG. 14

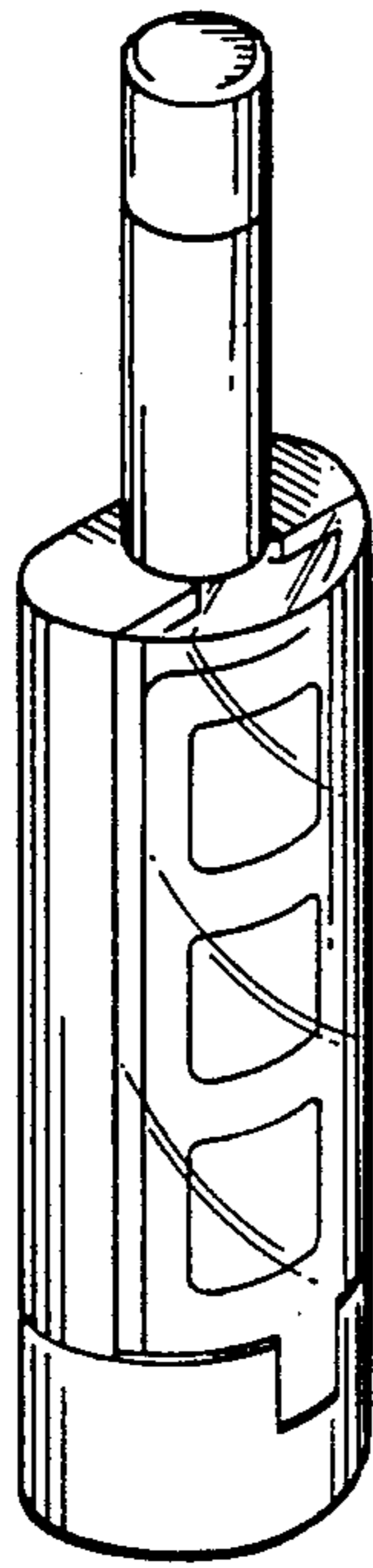

FIG. 15

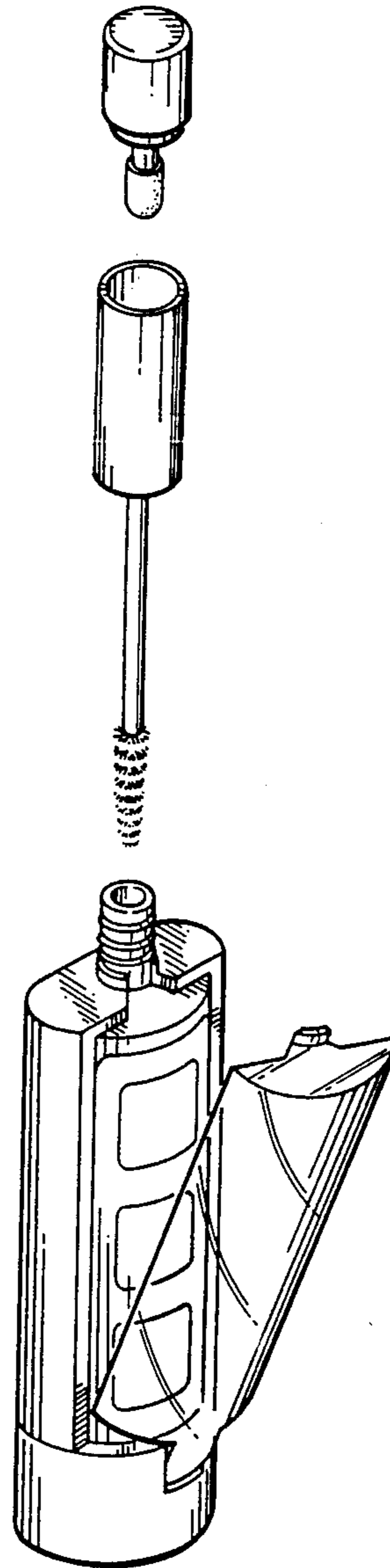

FIG. 16