

# United States Patent [19]

Sakata

[11] Patent Number: Des. 307,056

[45] Date of Patent: \*\* Apr. 3, 1990

[54] BRICK

[75] Inventor: Kiyoshi Sakata, Tokyo, Japan

[73] Assignee: Park Kyung Hee, Tokyo, Japan

[\*\*] Term: 14 Years

[21] Appl. No.: 38,889

[22] Filed: Apr. 10, 1987

[30] Foreign Application Priority Data

Oct. 15, 1986 [JP] Japan ..... 61-40560

[52] U.S. Cl. .... D25/114; D25/113;  
D25/138

[58] Field of Search ..... D25/113-118,  
D25/138-163; 52/606, 608; 404/41

[56] References Cited

U.S. PATENT DOCUMENTS

D. 30,072 1/1899 Thomas ..... D25/138  
2,882,689 4/1959 Huch et al. .... D25/113 X

FOREIGN PATENT DOCUMENTS

2415782 10/1975 Fed. Rep. of Germany .... D25/138

Primary Examiner—A. Hugo Word  
Attorney, Agent, or Firm—Lowe, Price, LeBlanc,  
Becker & Shur

[57] CLAIM

The ornamental design for a brick, as shown.

DESCRIPTION

FIG. 1 is a perspective view of a brick showing my new design;

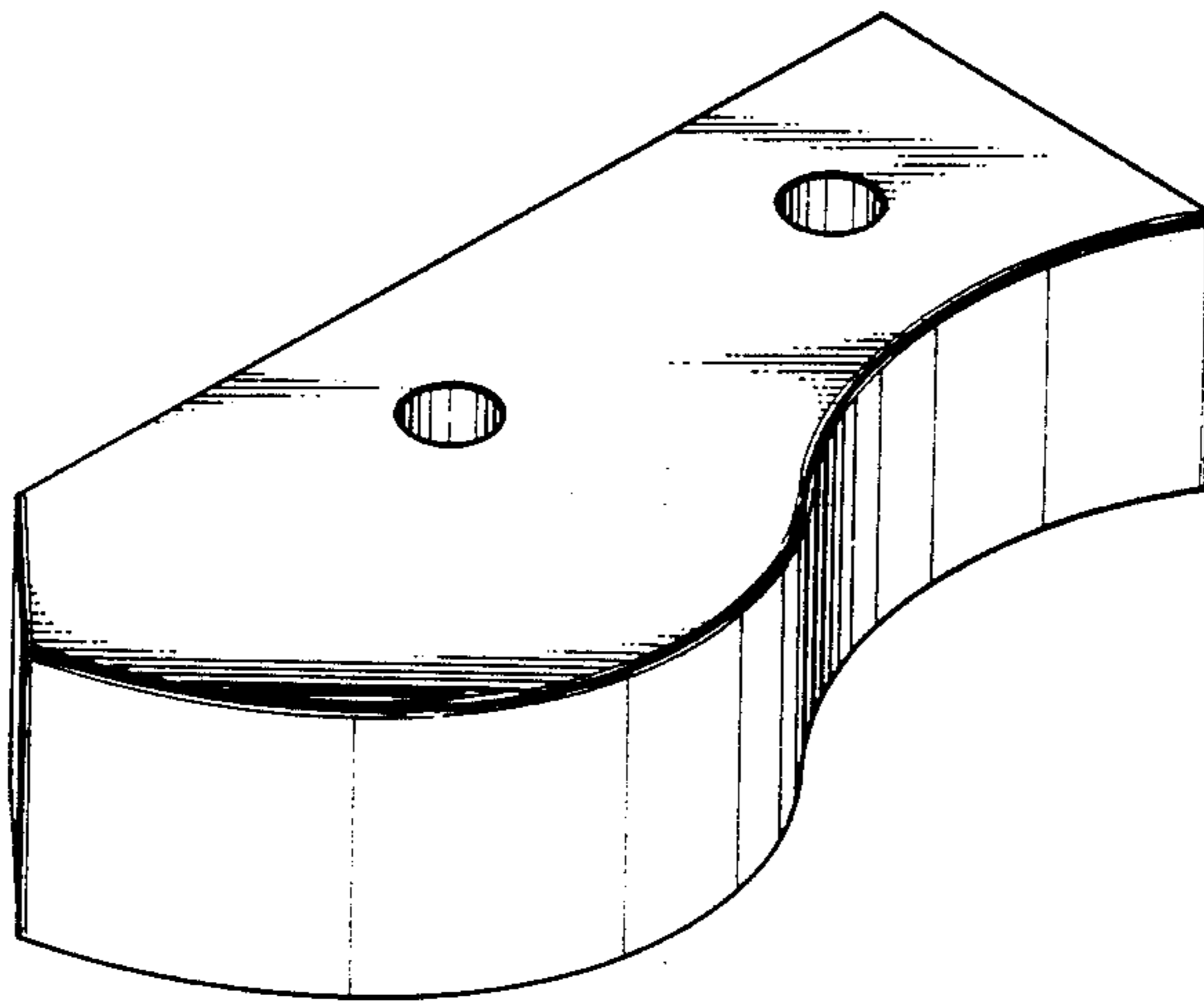
FIG. 2 is a top plan view thereof;

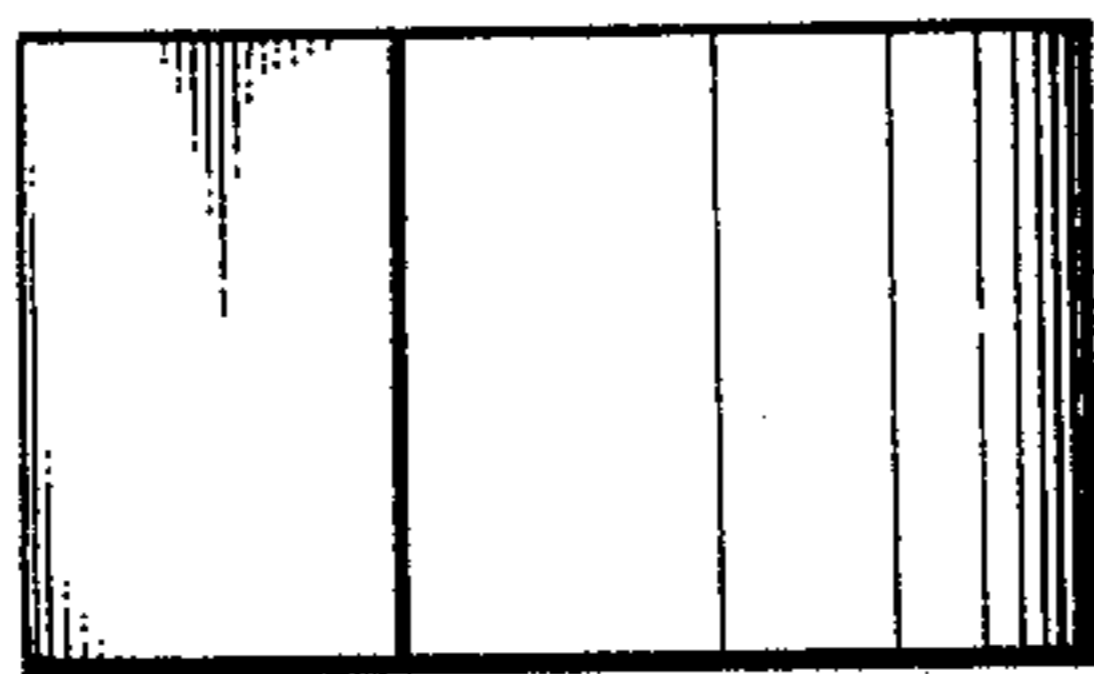
FIG. 3 is a front elevational view thereof;

FIG. 4 is a rear elevational view thereof;

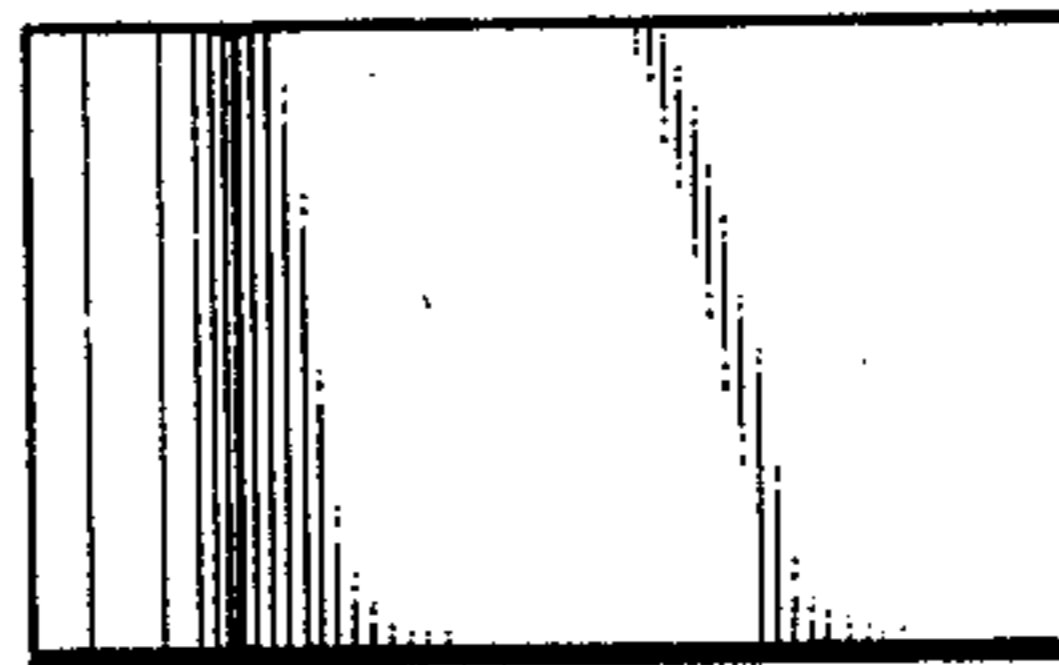
FIG. 5 is a left end elevational view thereof; and

FIG. 6 is a right end elevational view thereof.

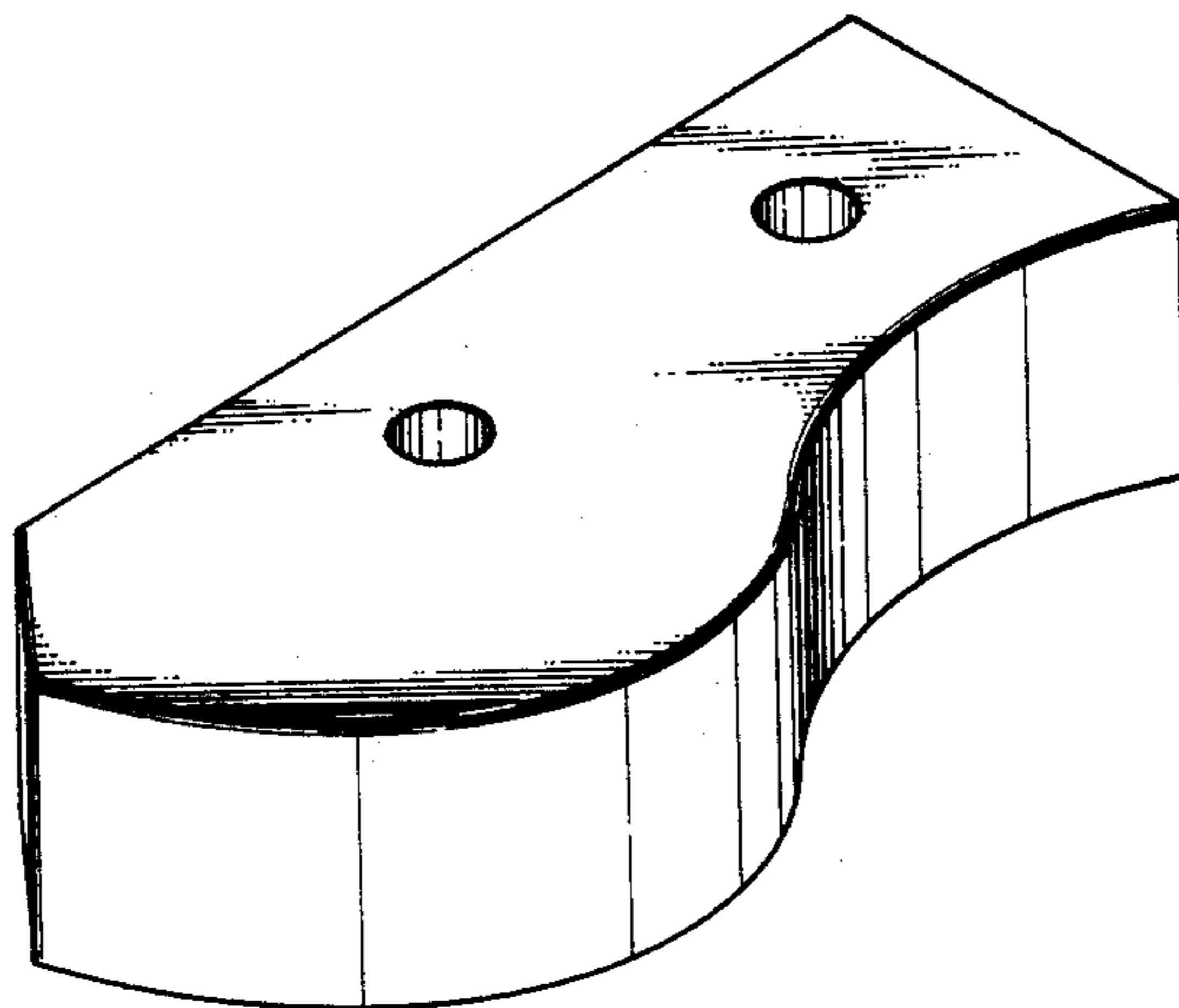




*Fig 5*



*Fig 6*



*Fig 1*

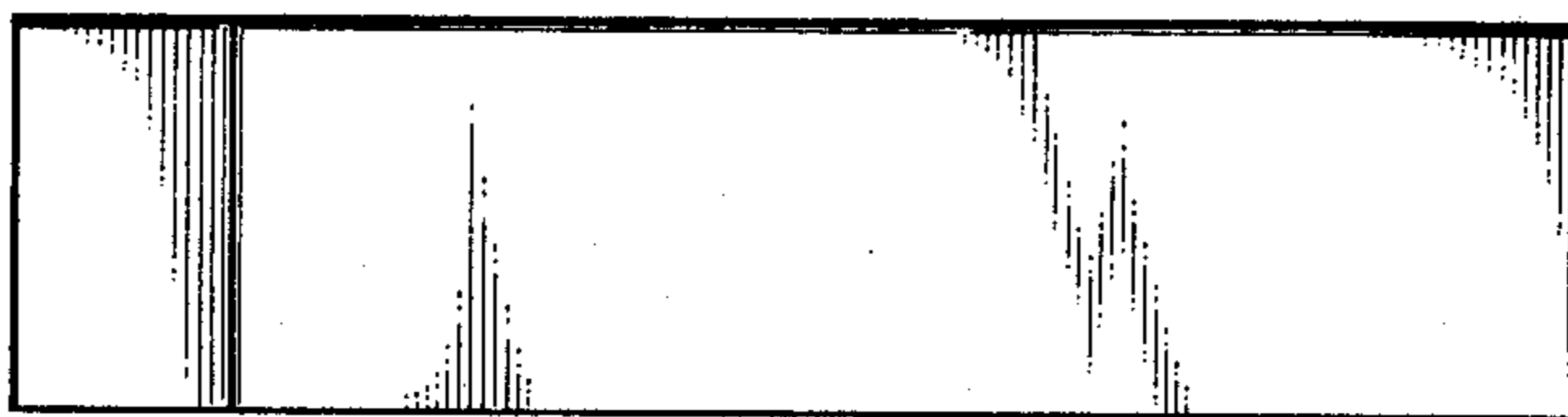


Fig 2

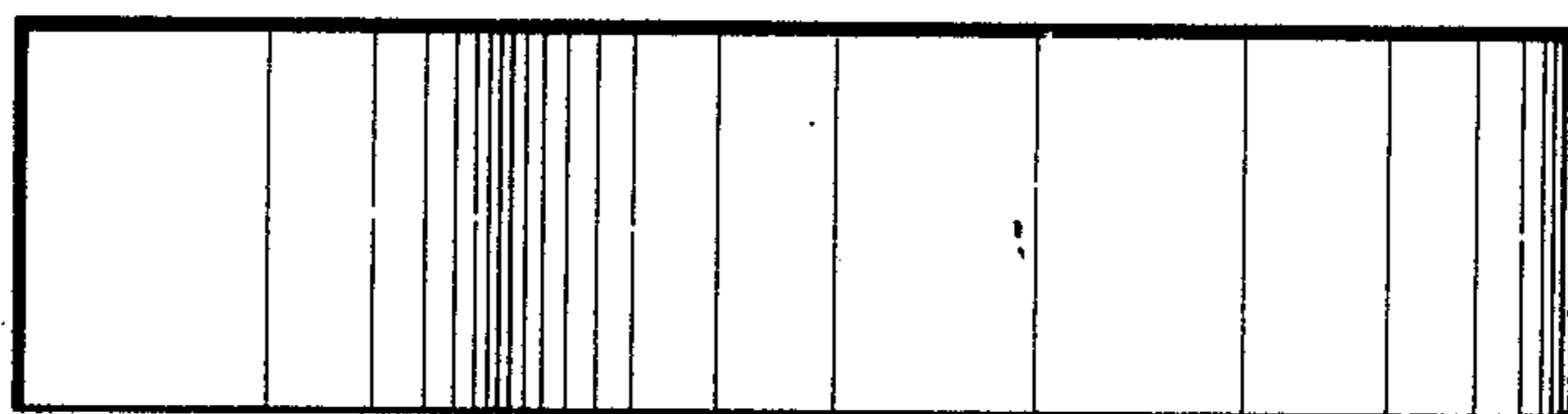


Fig 3

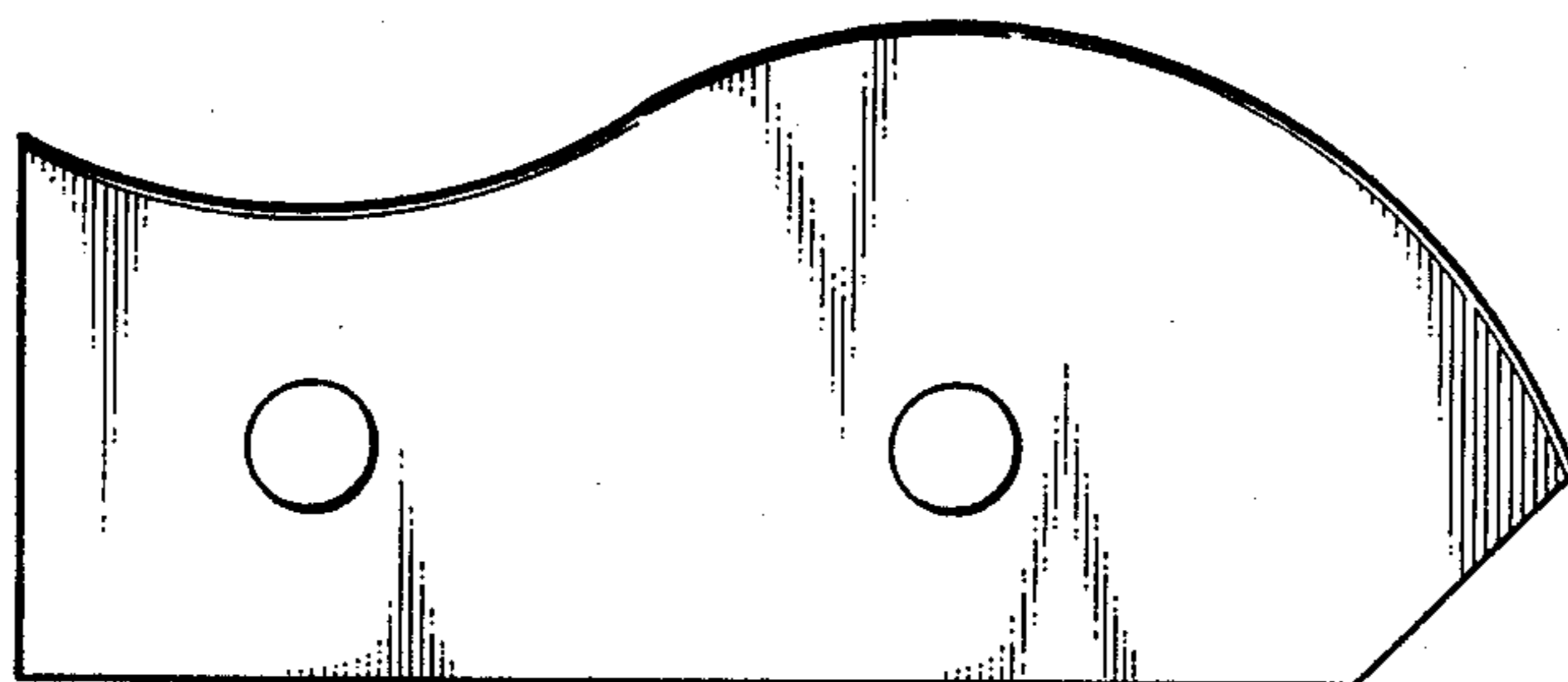


Fig 4