

[54] FAUCET HANDLE

[75] Inventor: Holly K. Yost, North Hollywood, Calif.

[73] Assignee: Price Pfister, Inc., Pacoima, Calif.

[**] Term: 14 Years

[21] Appl. No.: 9,382

[22] Filed: Jan. 30, 1987

[52] U.S. Cl. D23/252; D8/307

[58] Field of Search D23/233-254; D8/300-322; 16/110-127

[56] References Cited

U.S. PATENT DOCUMENTS

- D. 96,944 9/1935 Triplett D8/311
- D. 138,322 7/1944 Melicher D8/311

- D. 146,267 1/1947 Simpson D8/311
- D. 189,970 3/1961 Prohaska D8/311
- D. 192,002 12/1961 Young D23/252
- D. 194,228 12/1962 Shames et al. D23/252

Primary Examiner—James R. Largen
Attorney, Agent, or Firm—Barry E. Deutsch

[57] CLAIM

The ornamental design for a faucet handle, as shown and described.

DESCRIPTION

FIG. 1 is a top plan view of a faucet handle incorporating my new design.
 FIG. 2 is a right side elevational view thereof, the left side being a mirror image of the right side shown.
 FIG. 3 is a bottom plan view thereof.
 FIG. 4 is a front elevational view thereof.
 FIG. 5 is a rear elevational view thereof.

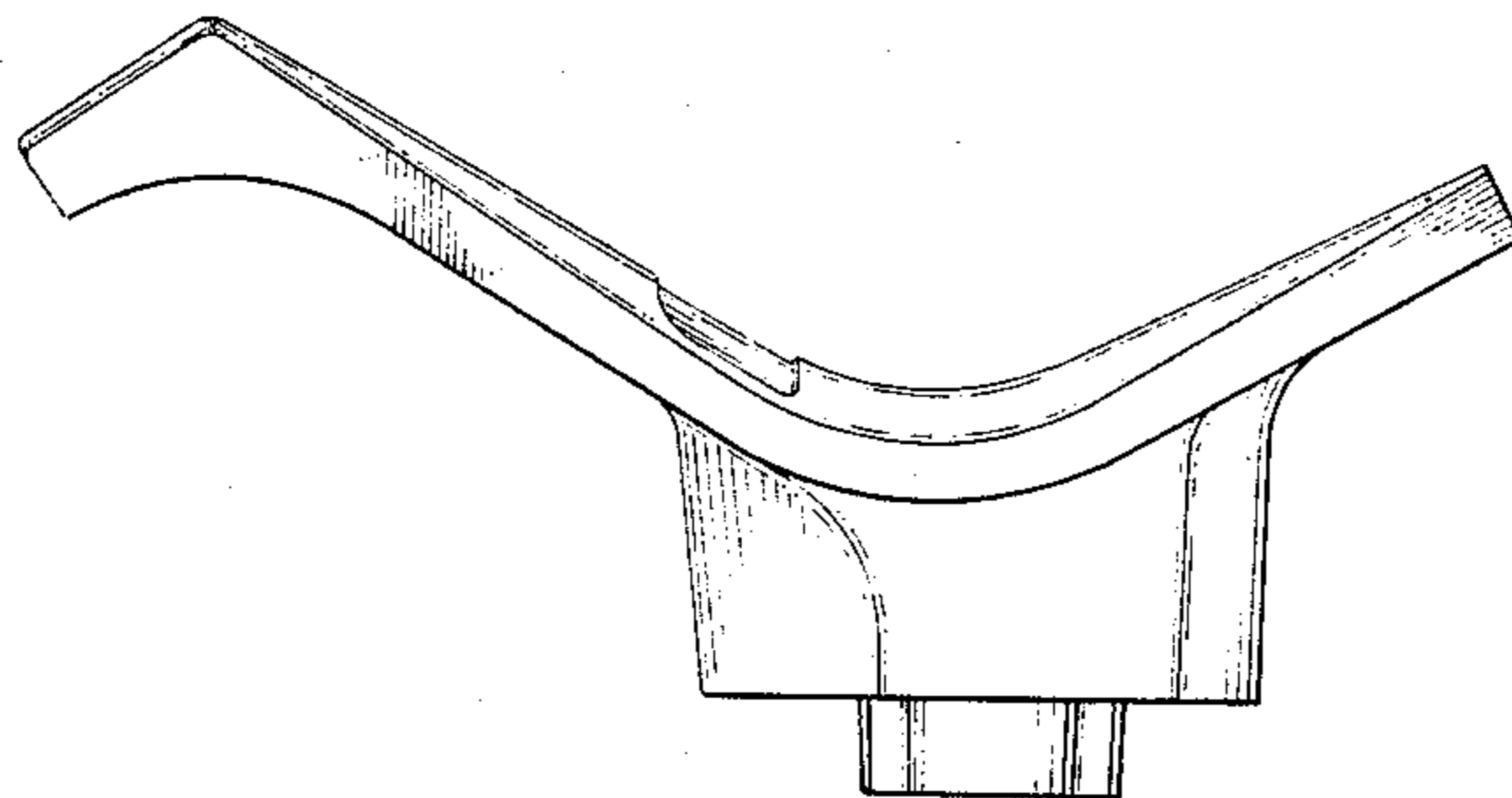
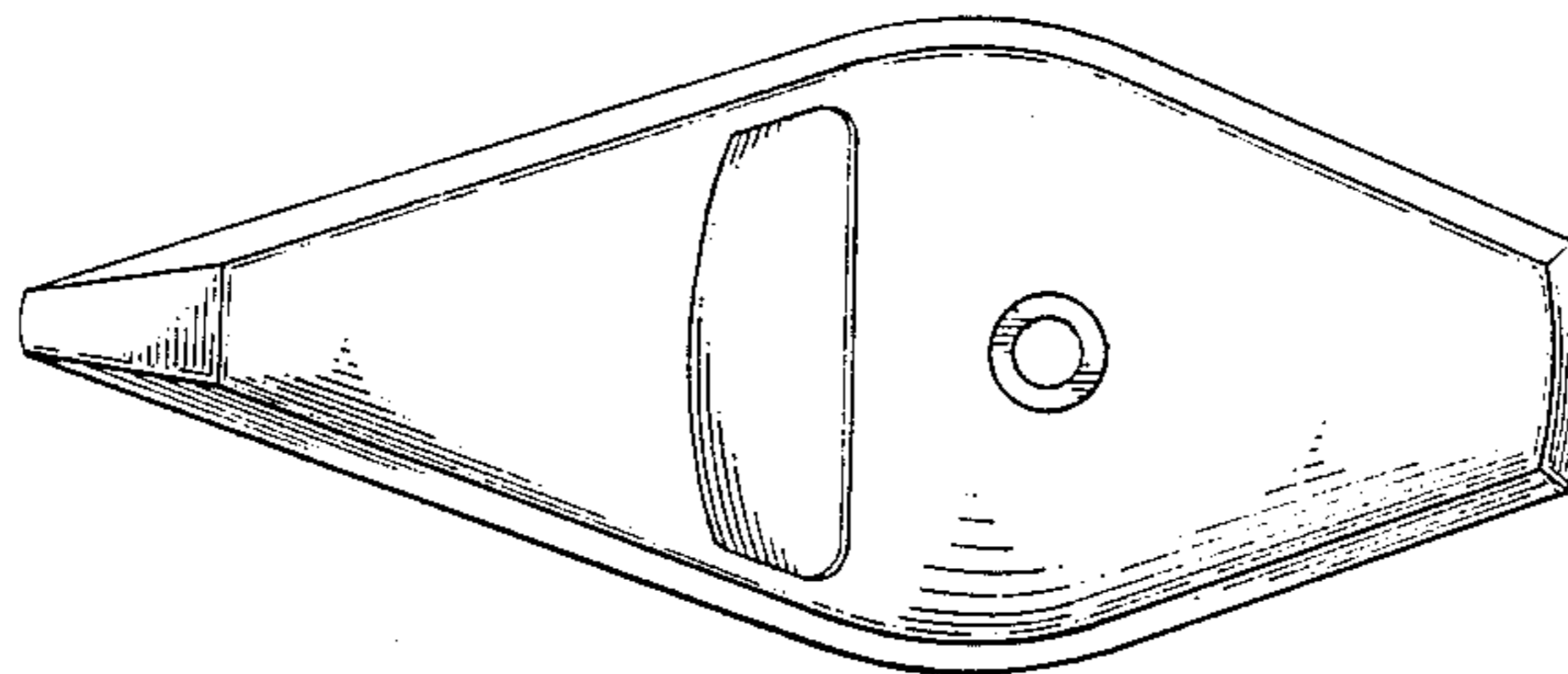

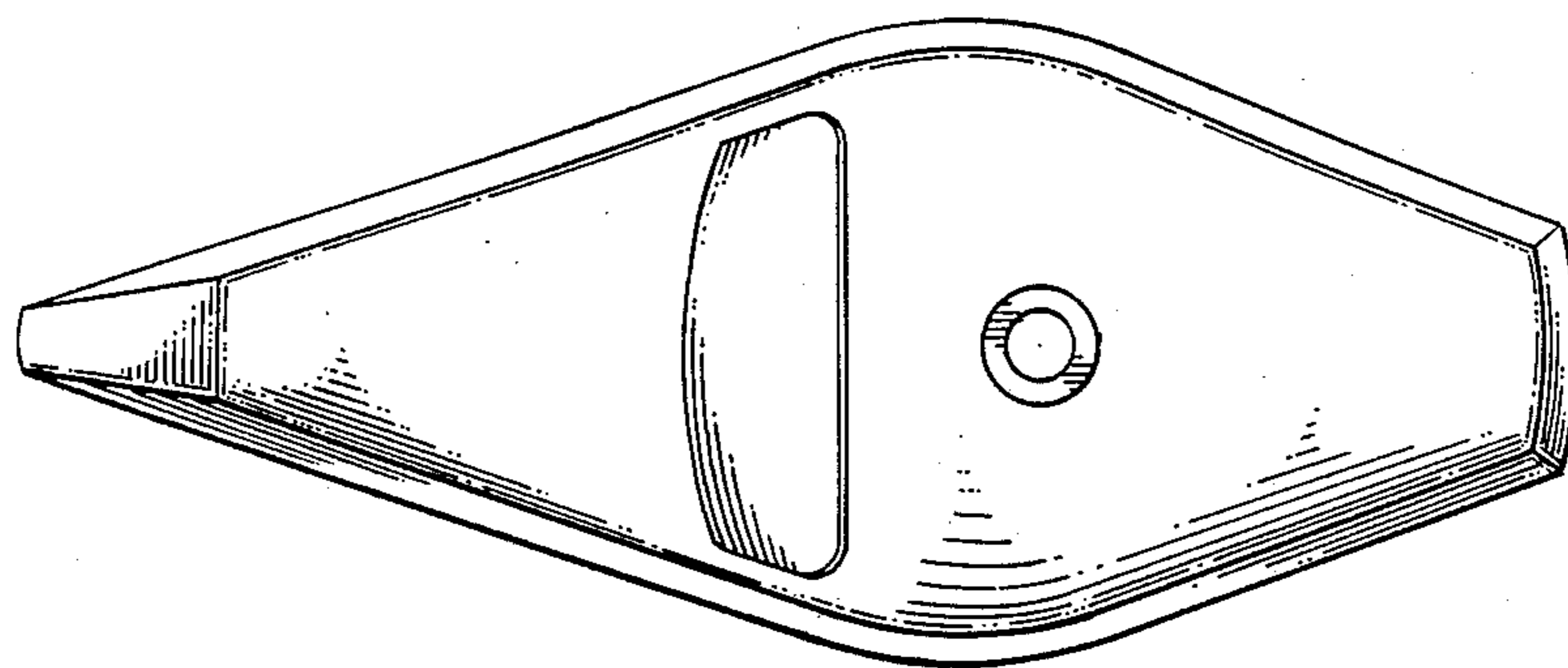

Fig. 1

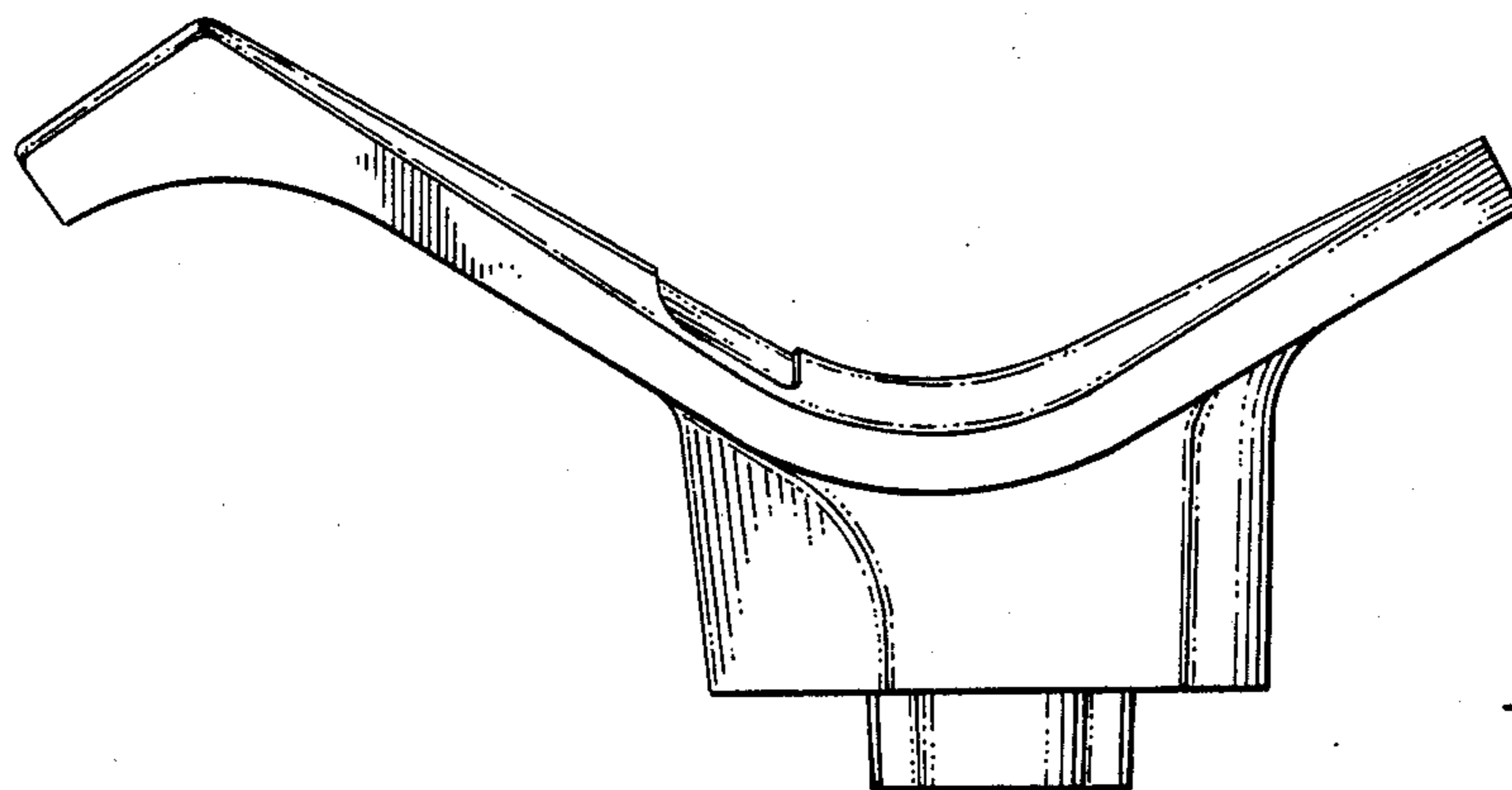

Fig. 2

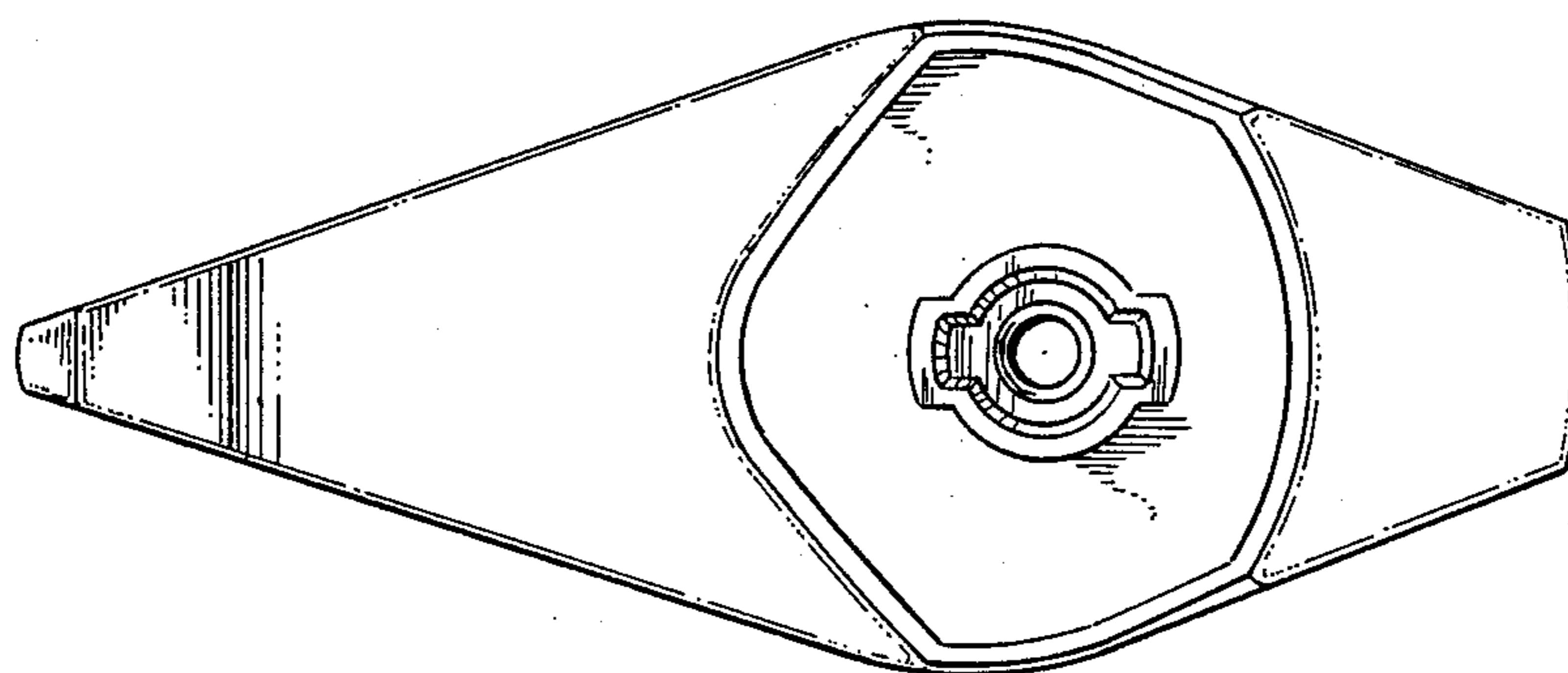

Fig. 3

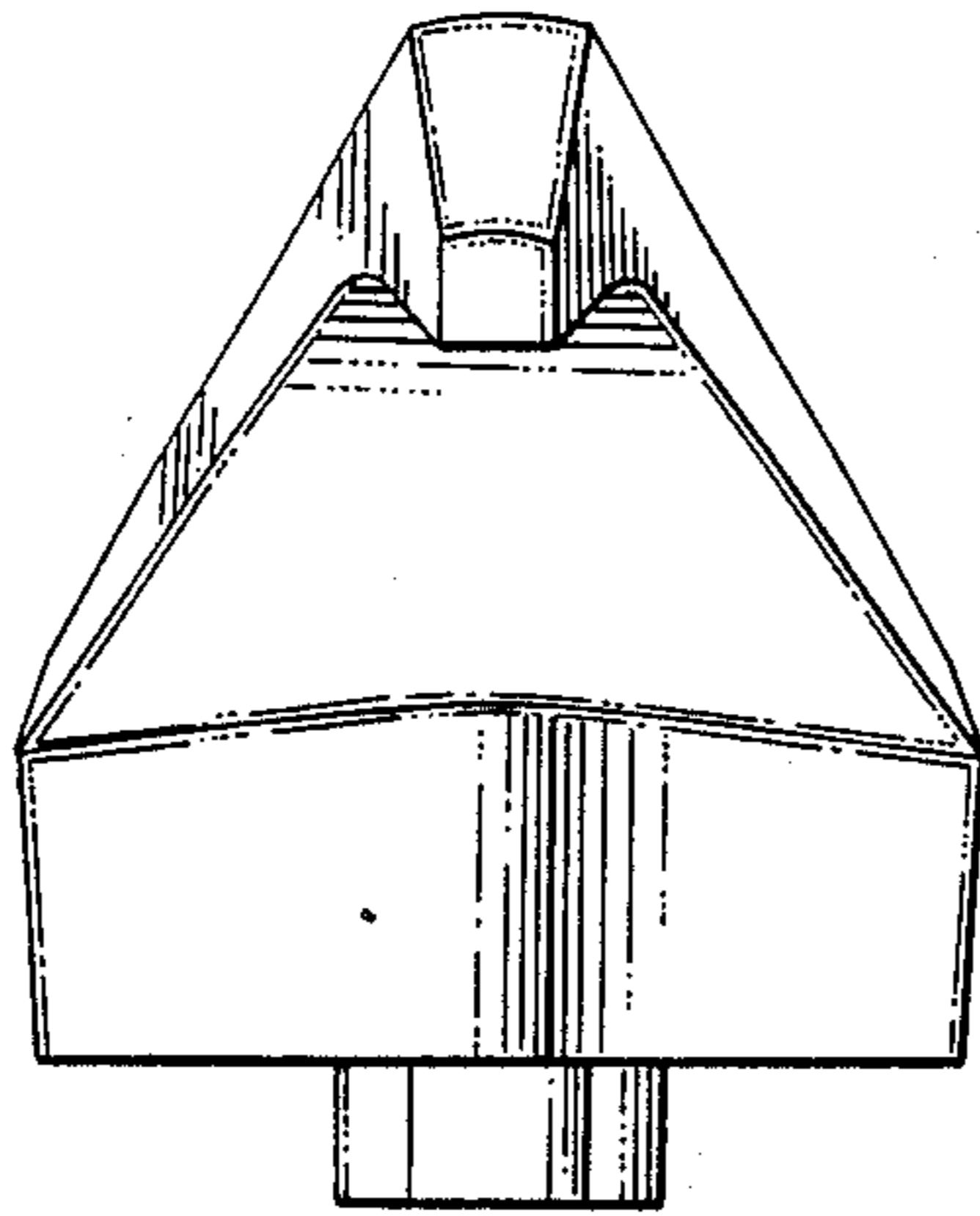

Fig. 4

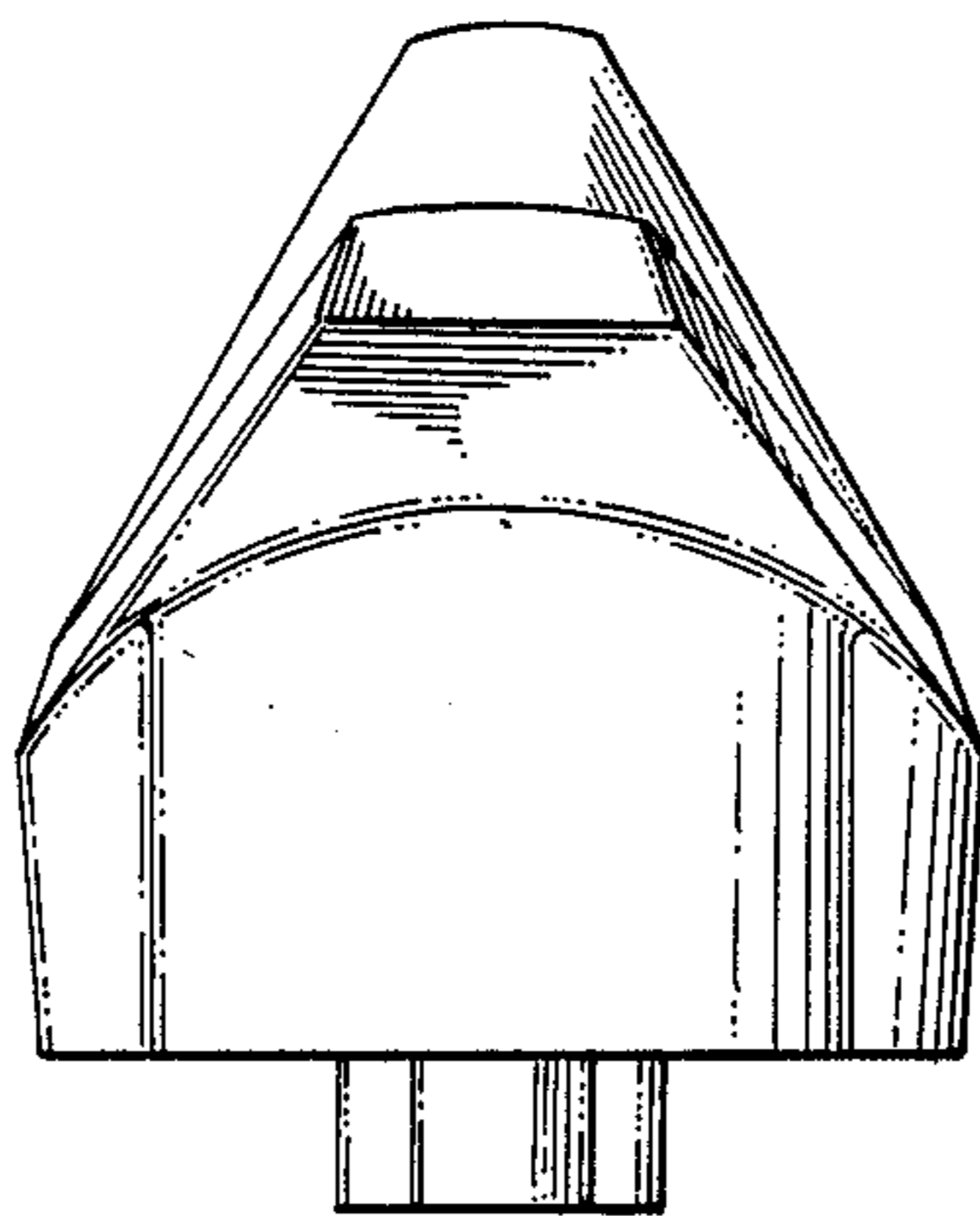

Fig. 5