

[54] COMBINED CIGARETTE AND LIGHTER HOLDER, BEVERAGE HOLDER AND TRAY FOR AN AUTOMOBILE DASH

D. 263,784 4/1982 Butler et al. D27/134 X
D. 296,725 7/1988 Iacovelli D3/40

[75] Inventors: Pierre Charet; Duke Kraai, both of Miami, Fla.

Primary Examiner—James R. Largen
Assistant Examiner—Y. Brunot
Attorney, Agent, or Firm—Wells & White

[73] Assignee: Rally Manufacturing, Inc., Miami, Fla.

[57] CLAIM

[*] Notice: The portion of the term of this patent subsequent to Jul. 19, 2002 has been disclaimed.

The ornamental design for a combined cigarette and lighter holder, beverage holder and tray for an automobile dash, as shown.

[**] Term: 14 Years

DESCRIPTION

[21] Appl. No.: 864,126

FIG. 1 is a right front perspective view of a combined cigarette and light holder, beverage holder and tray for an automobile dash in a closed condition showing my new design;

[22] Filed: May 16, 1986

[52] U.S. Cl. D3/40

FIG. 2 is a right front perspective view of a combined cigarette and lighter holder, beverage holder and tray for an automobile dash in open condition;

[58] Field of Search 220/427, DIG. 13, DIG. 14; D3/39, 40

FIG. 3 is a right front perspective view as taken from FIG. 2 with the cigarette and lighter holder in place and holder in fully extended position;

[56] References Cited

U.S. PATENT DOCUMENTS

- D. 121,595 7/1940 Menn D3/39
- D. 142,425 9/1945 Klyce D27/134
- D. 145,008 6/1946 Crane D3/39
- D. 203,022 11/1965 Mayer D3/39
- D. 224,368 7/1972 Bettonica D3/39
- D. 257,800 1/1981 Pederson D3/39

FIG. 4 is a top plan view;

FIG. 5 is a front elevational view;

FIG. 6 is a right side elevational view, the left side being a mirror image thereof; and

FIG. 7 is a bottom plan view.

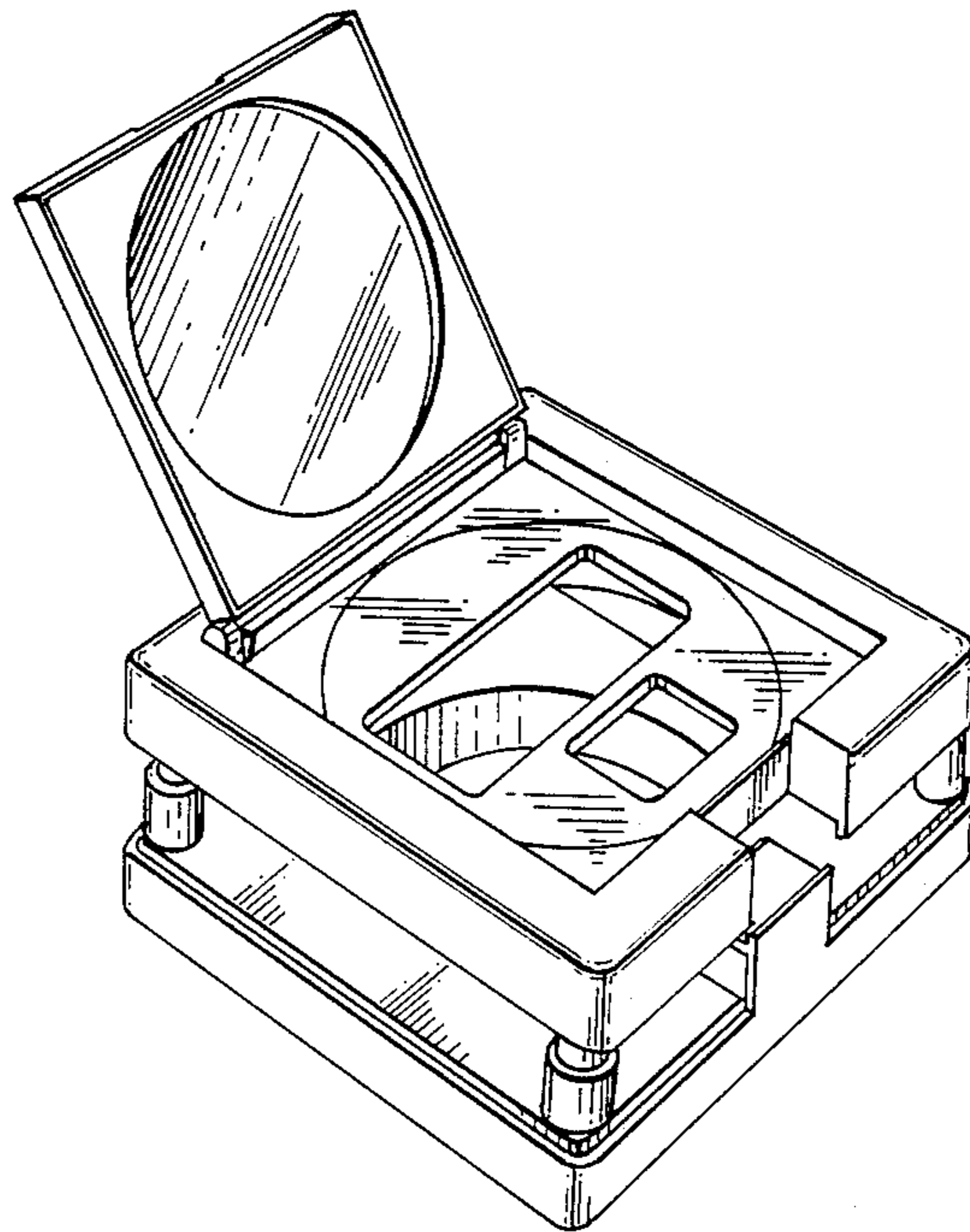

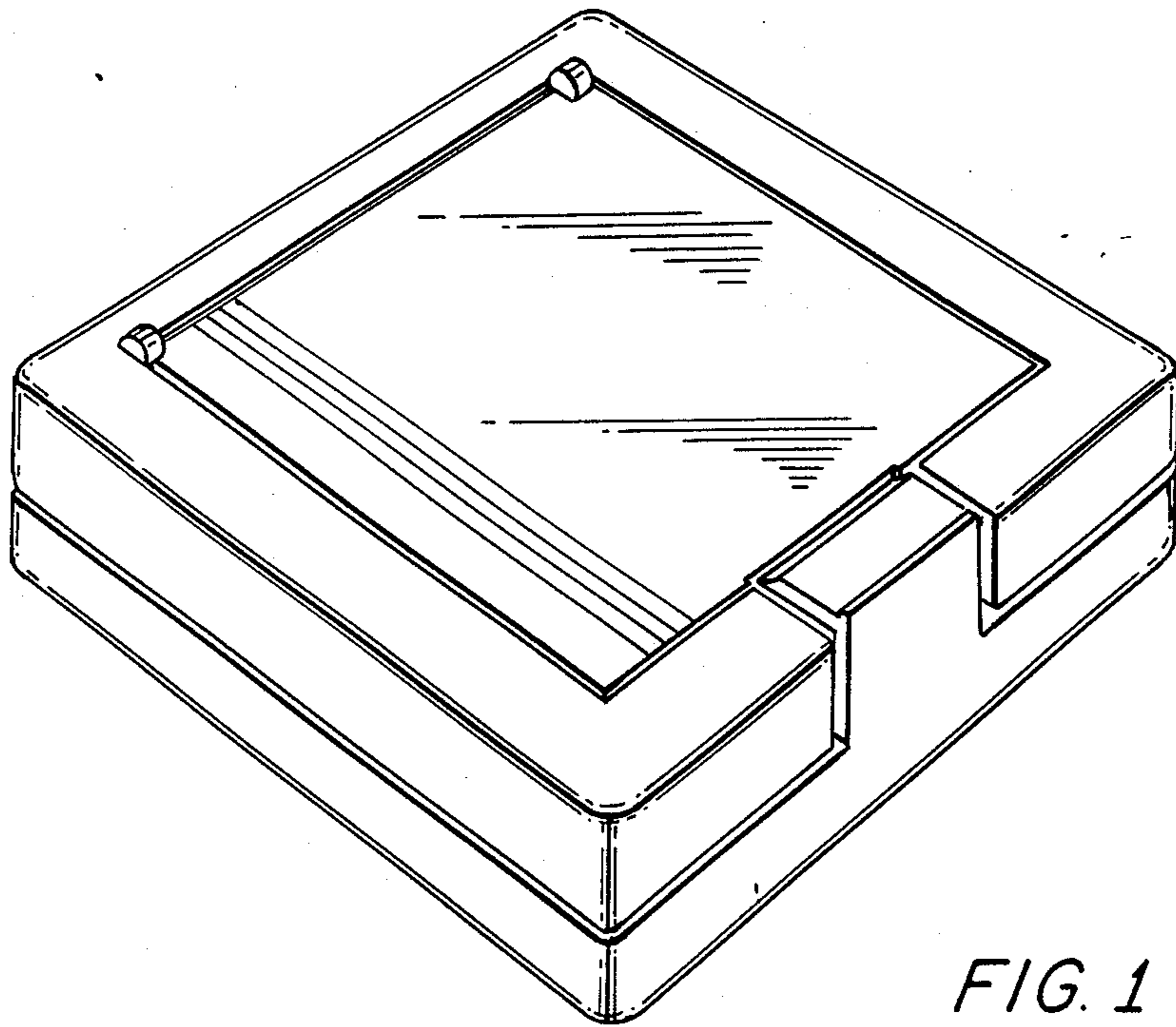

FIG. 1

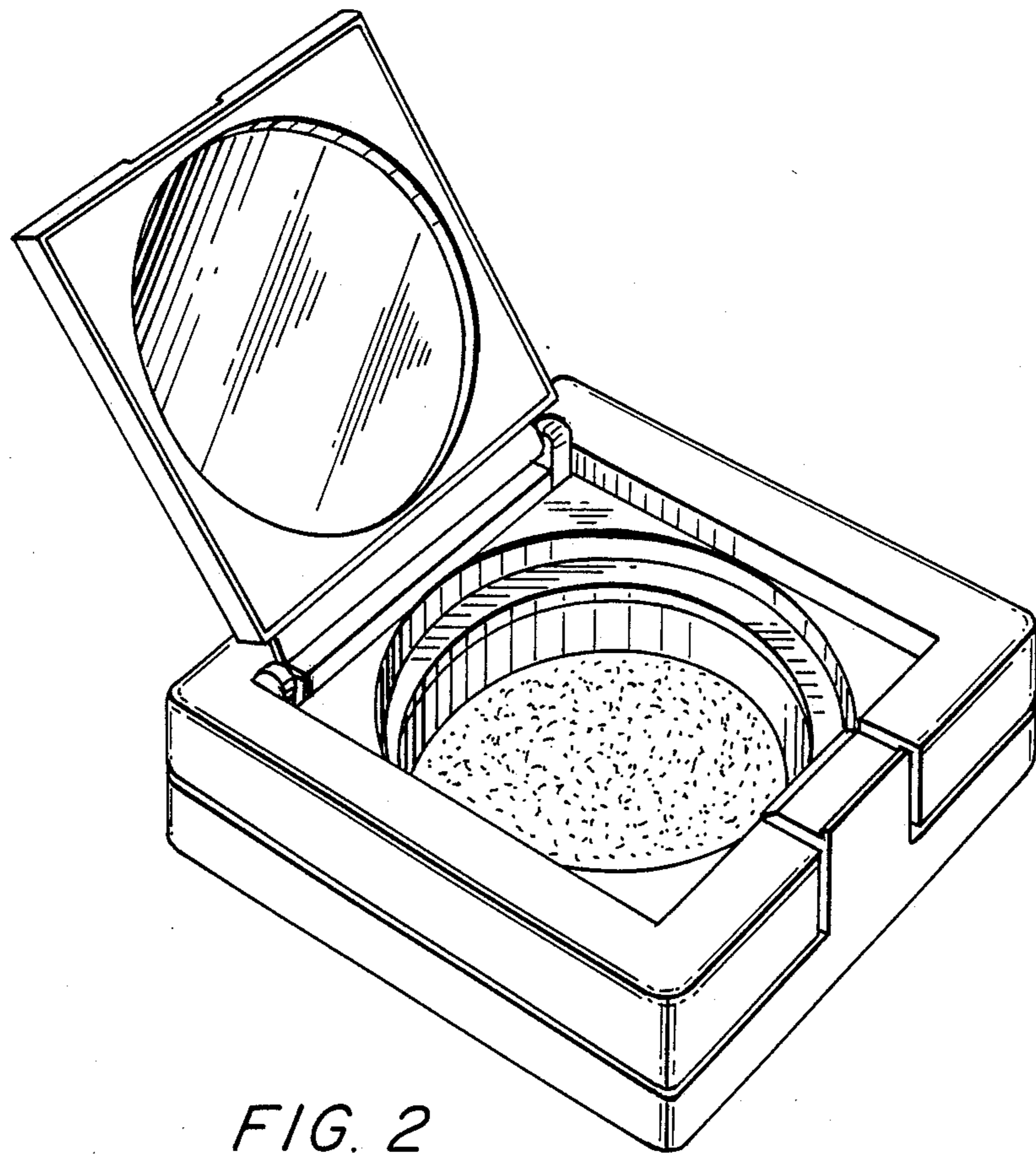

FIG. 2

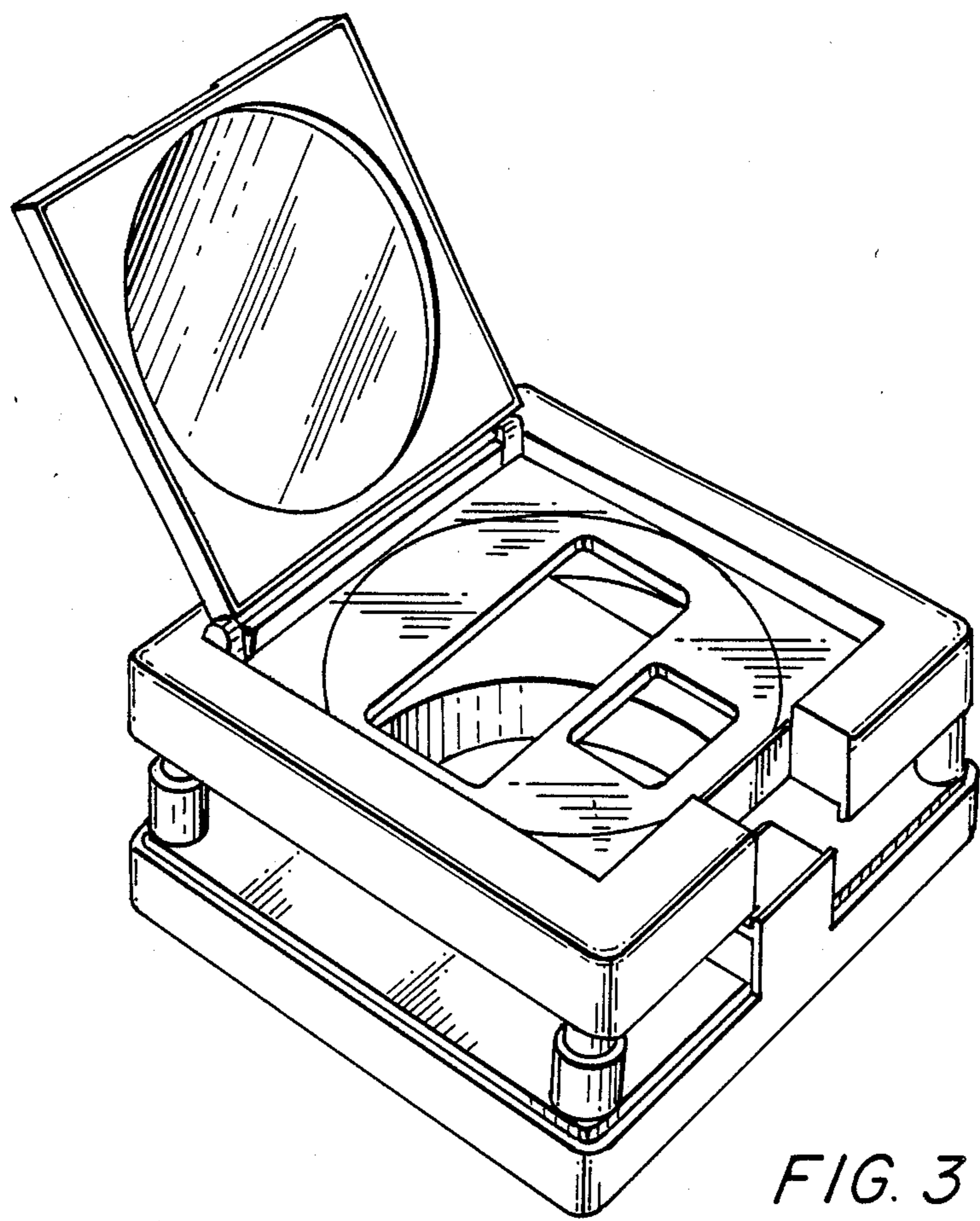

FIG. 3

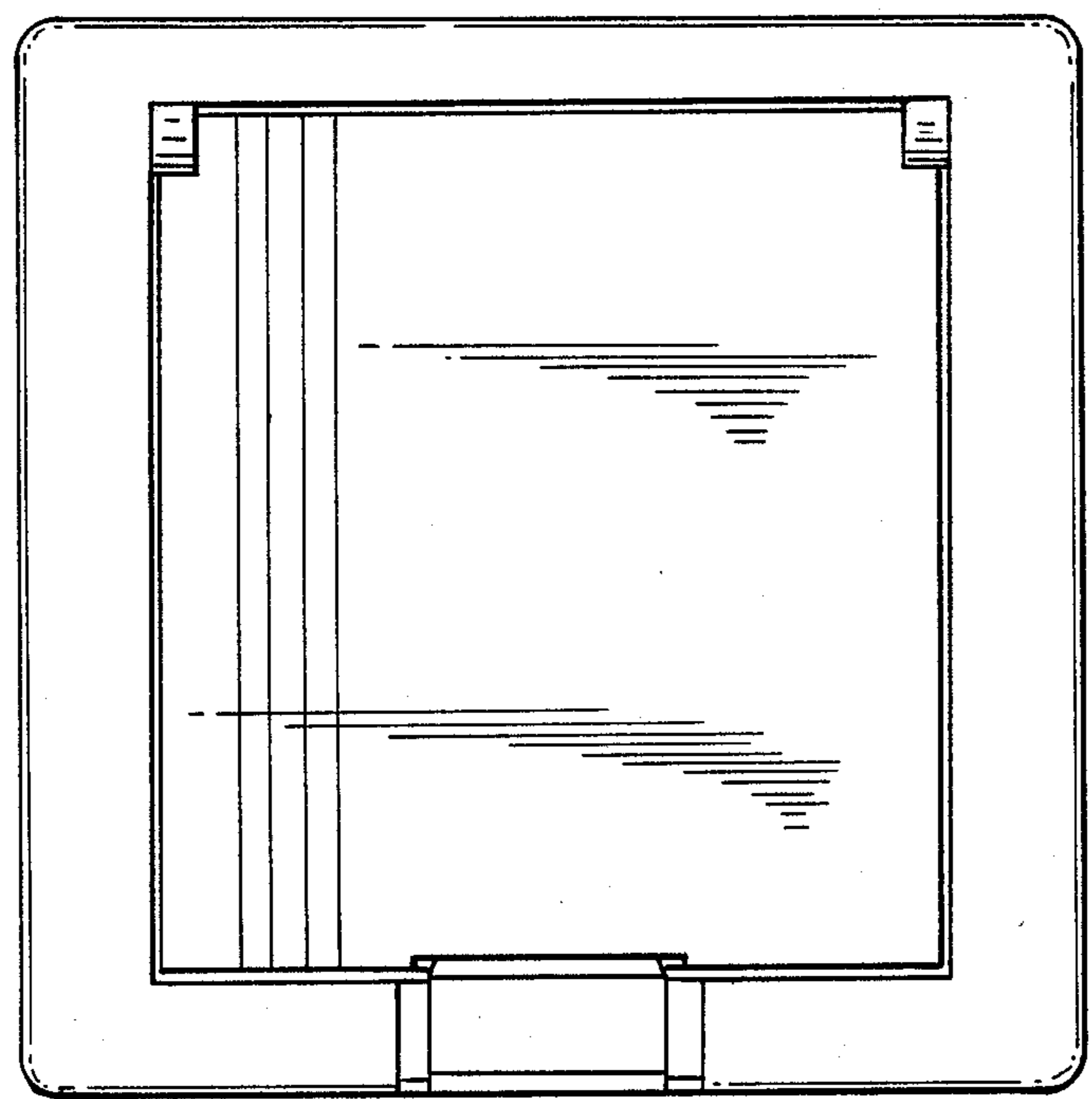

FIG. 4

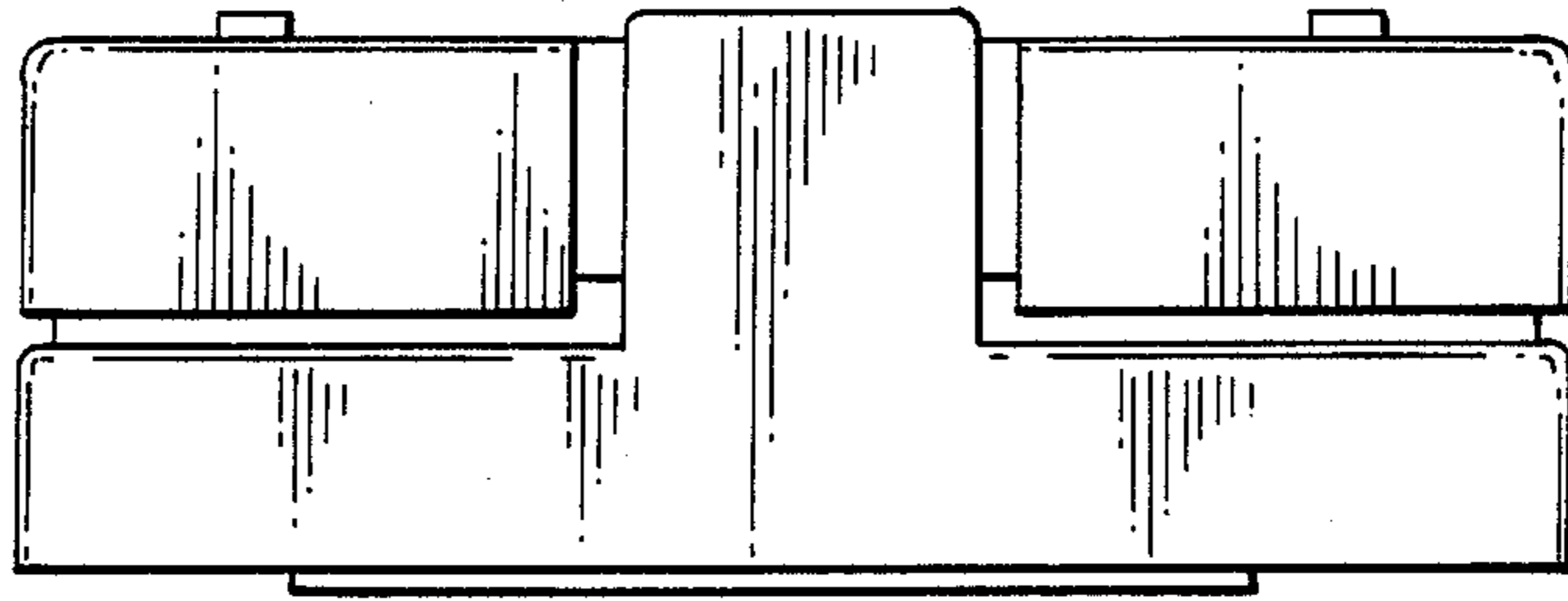

FIG. 5

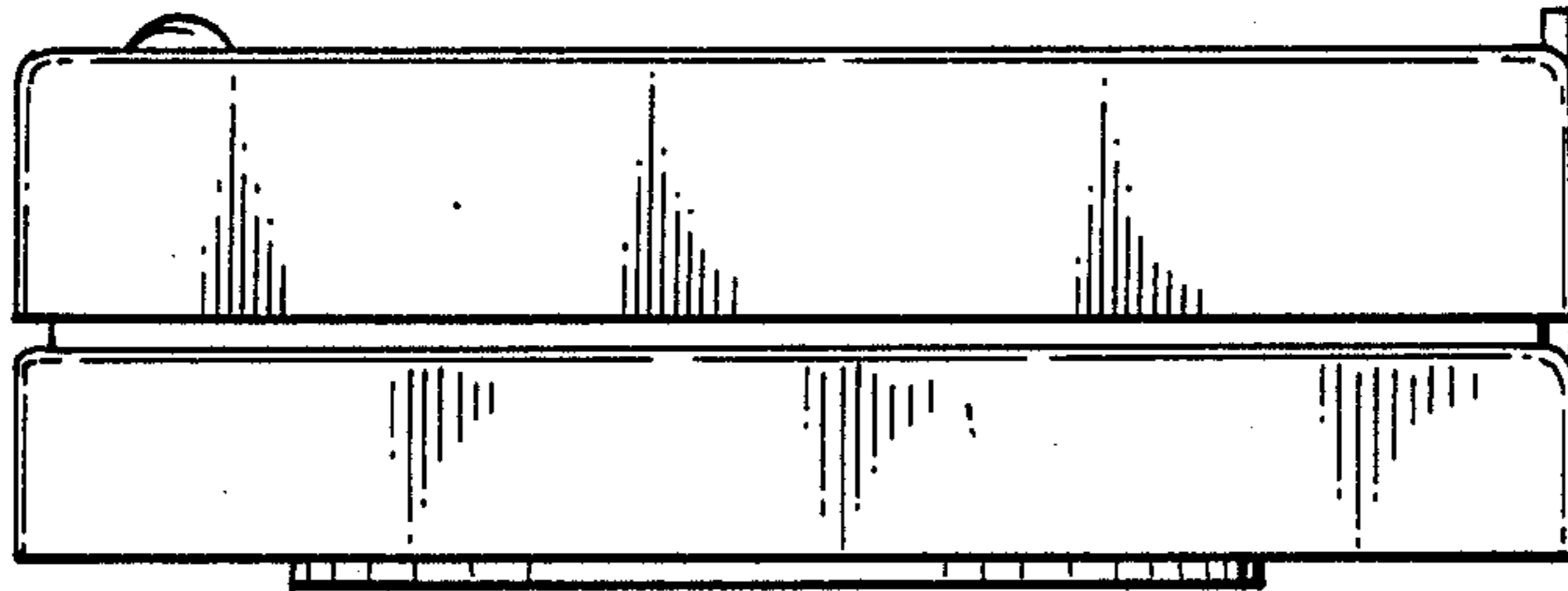

FIG. 6

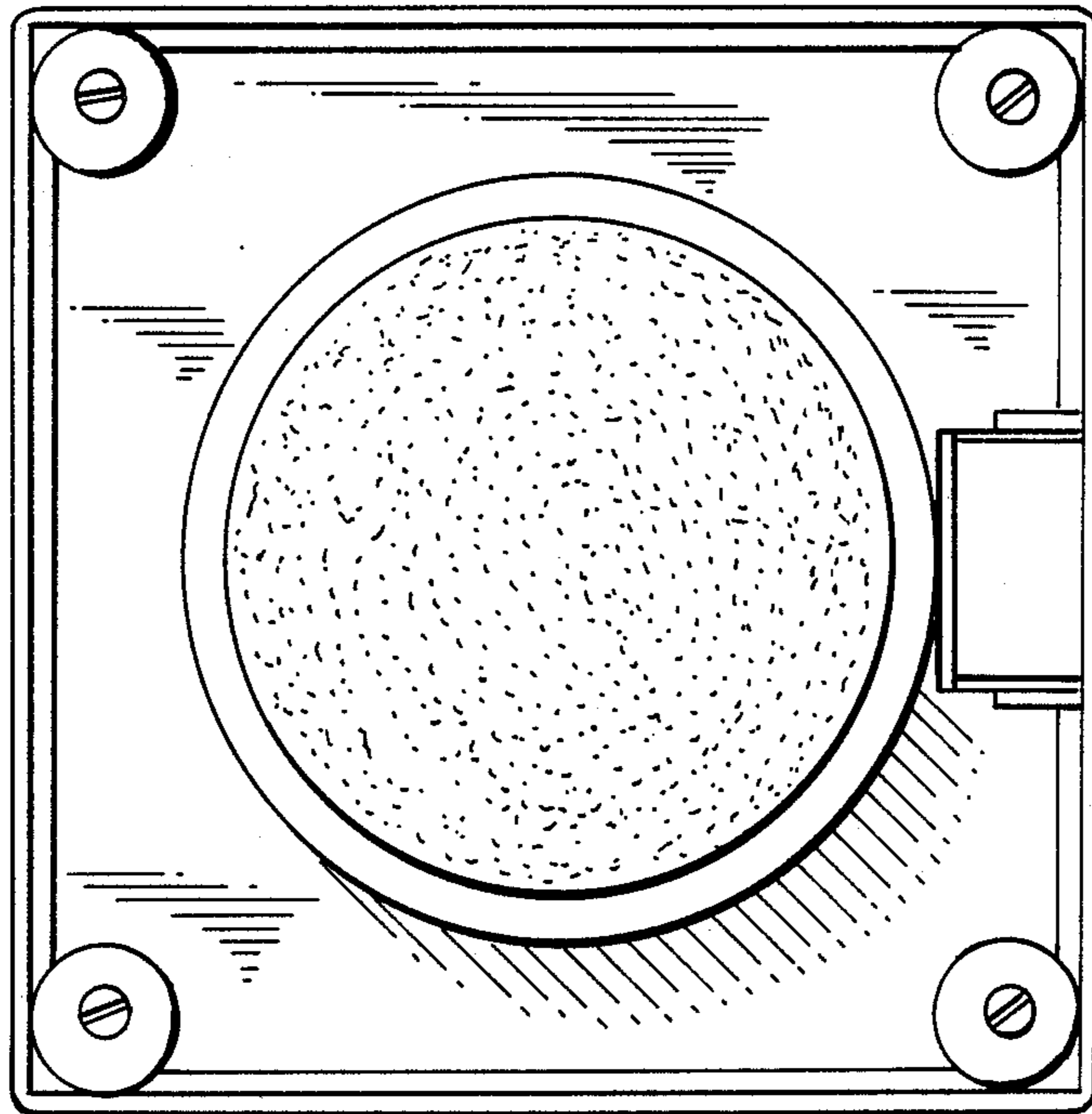

FIG. 7