

# United States Patent [19]

Luzenberg

[11] Patent Number: **Des. 306,915**

[45] Date of Patent: **\*\* Mar. 27, 1990**

[54] **SHAVER WITH SHAVING GEL DISPENSING UNIT**

[76] Inventor: **Robert S. Luzenberg**, 135 First St. East, Unit 301, Tierra Verde, Fla. 33715

[\*\*] Term: **14 Years**

[21] Appl. No.: **48,922**

[22] Filed: **Jun. 18, 1987**

[52] U.S. Cl. .... **D28/46**

[58] Field of Search ..... **D28/44-54;**  
30/29.5, 32, 34 R, 34.1, 41, 41.5, 47, 48, 50, 90,  
84-86

[56] **References Cited**

### U.S. PATENT DOCUMENTS

D. 270,195 8/1983 Gray ..... D28/46

D. 294,528 3/1988 Gray ..... D28/46  
2,820,287 1/1958 Hyatt ..... D28/46 X  
4,129,942 12/1978 Denizman ..... 30/41  
4,413,411 11/1983 Trotta ..... 30/85  
4,562,643 1/1986 Cataudella ..... 30/41

*Primary Examiner*—Louis S. Zarfes

### [57] CLAIM

The ornamental design for a shaver with shaving gel dispensing unit, as shown and described.

### DESCRIPTION

FIG. 1 is a rear isometric view of a shaver with shaving gel dispensing unit, showing my new design;  
FIG. 2 is a right side elevational view thereof;  
FIG. 3 is a top plan view thereof;  
FIG. 4 is a front elevational view thereof;  
FIG. 5 is a back elevational view thereof;  
FIG. 6 is a left side elevational view thereof; and  
FIG. 7 is a bottom plan view thereof.

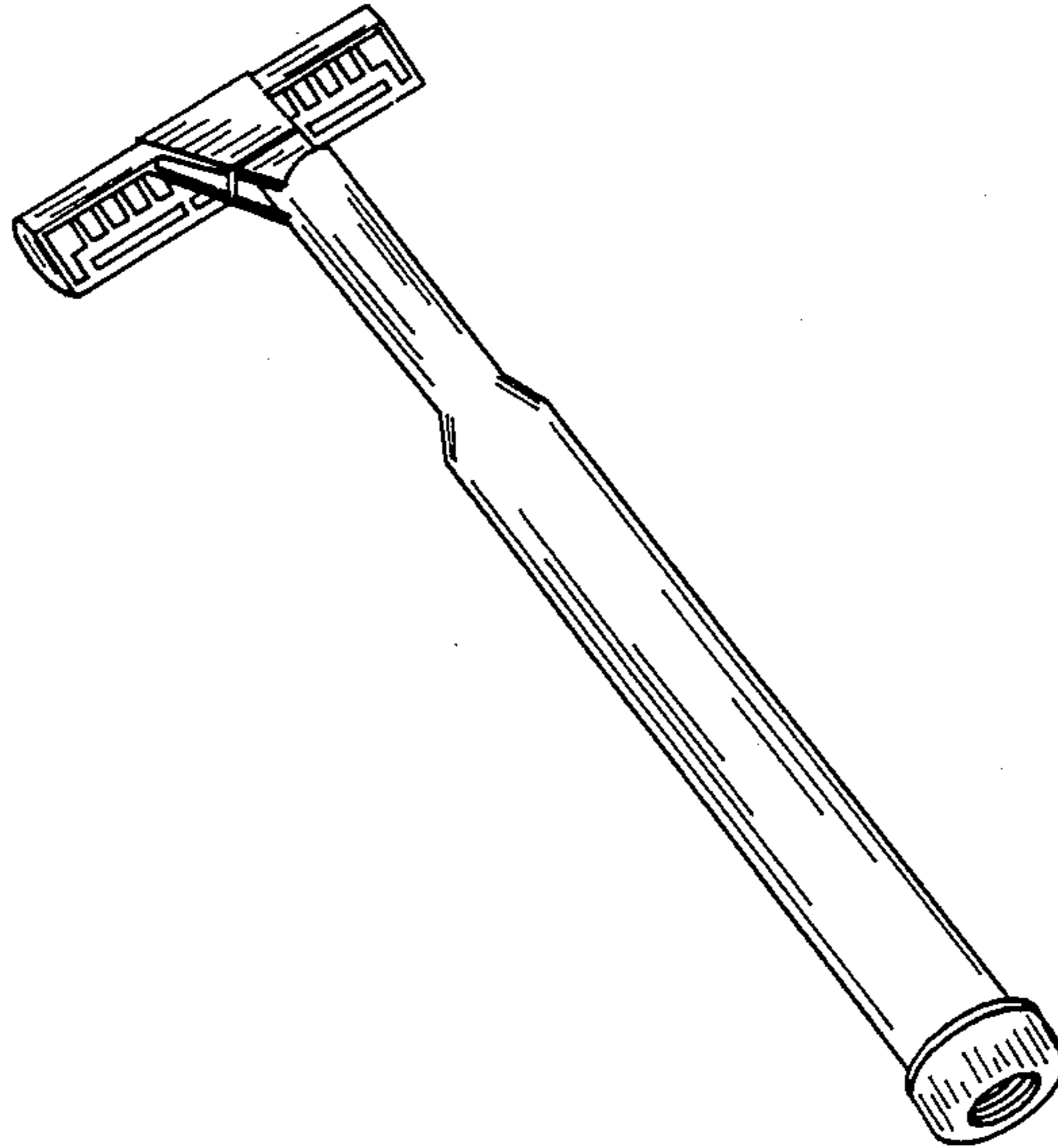

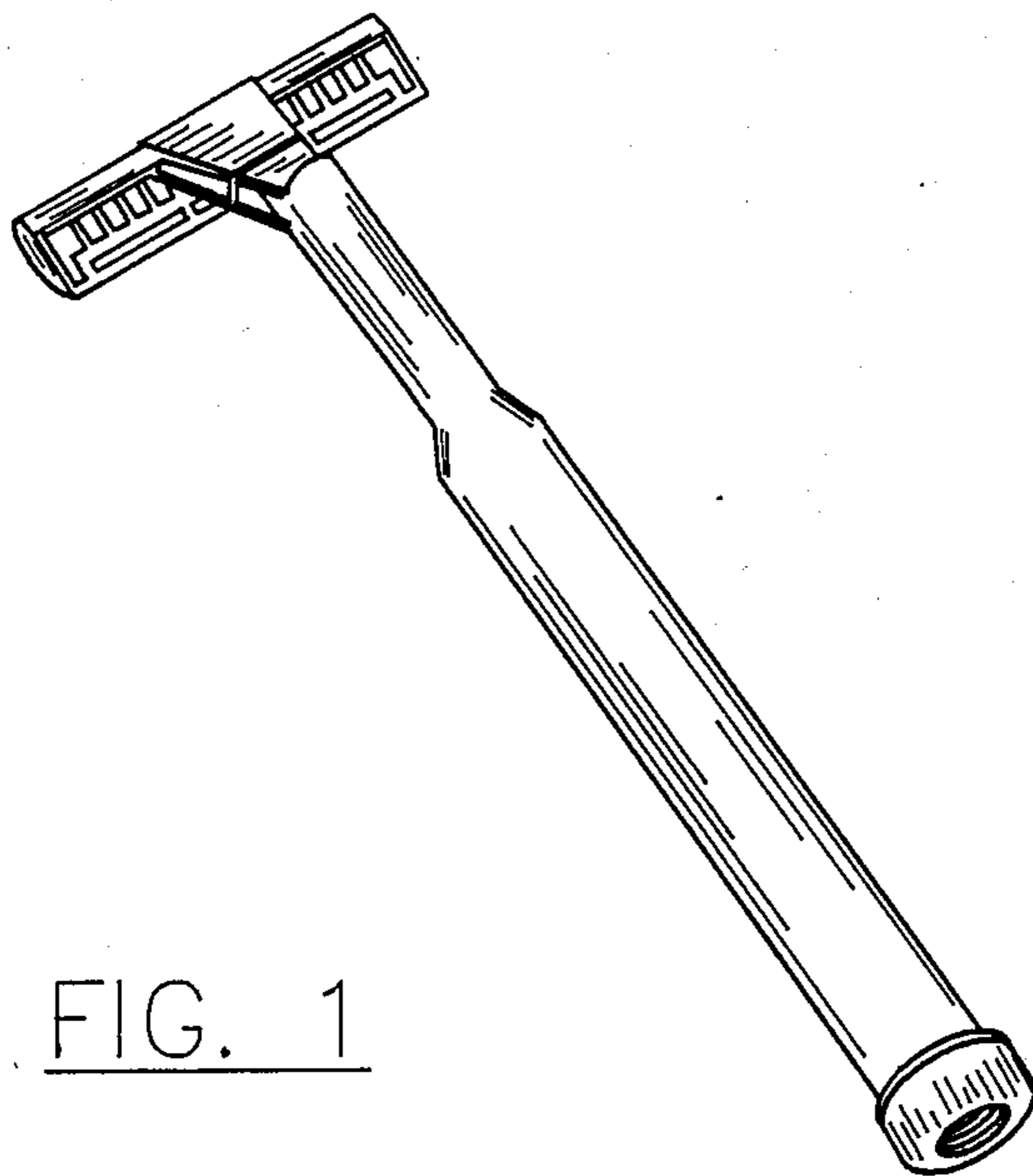

FIG. 1

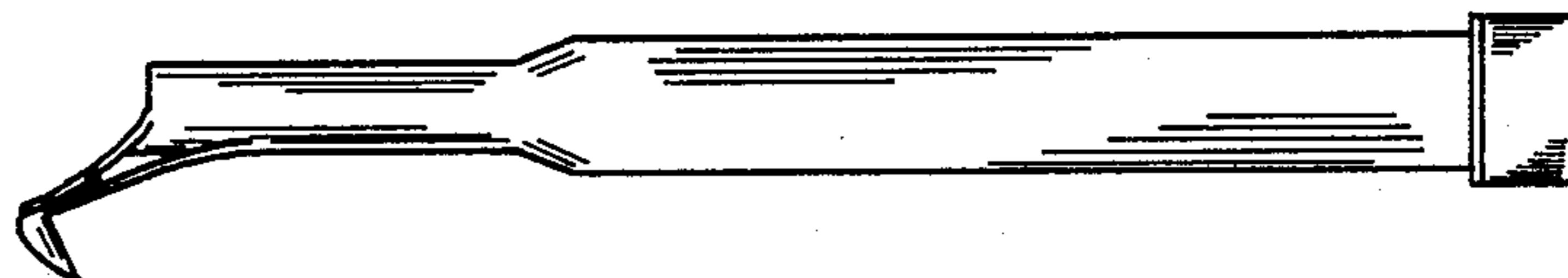

FIG. 2

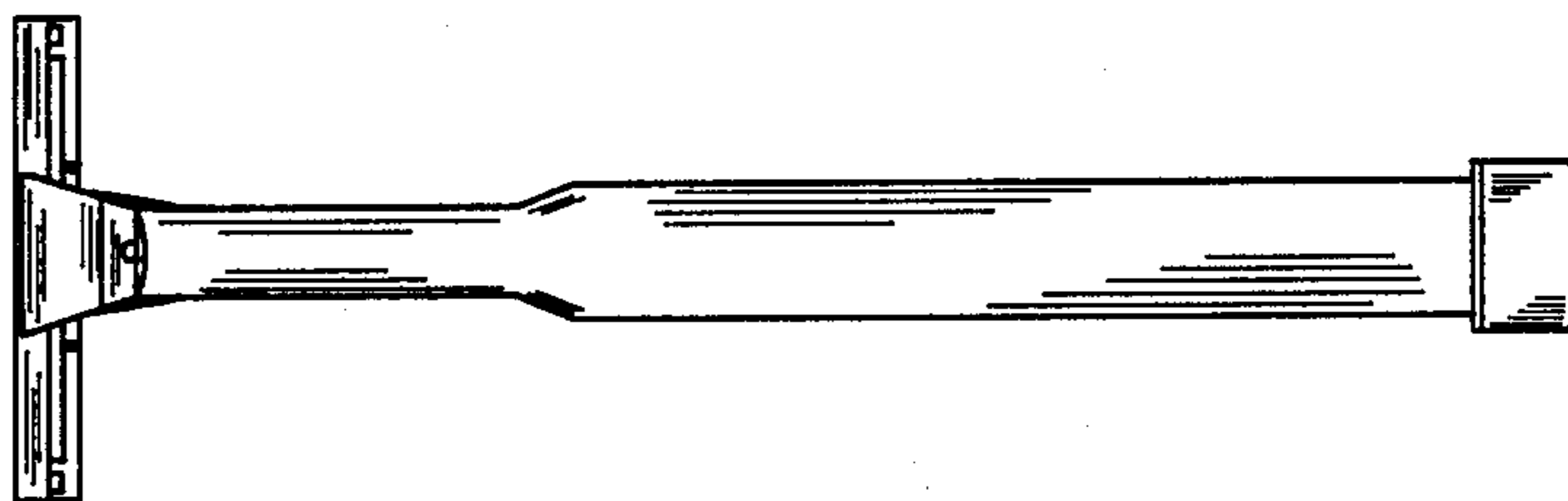

FIG. 3

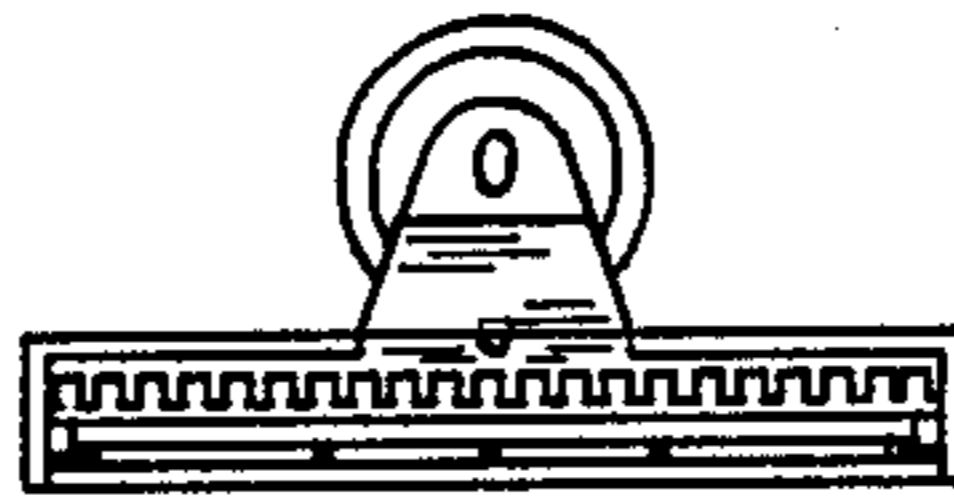

FIG. 4

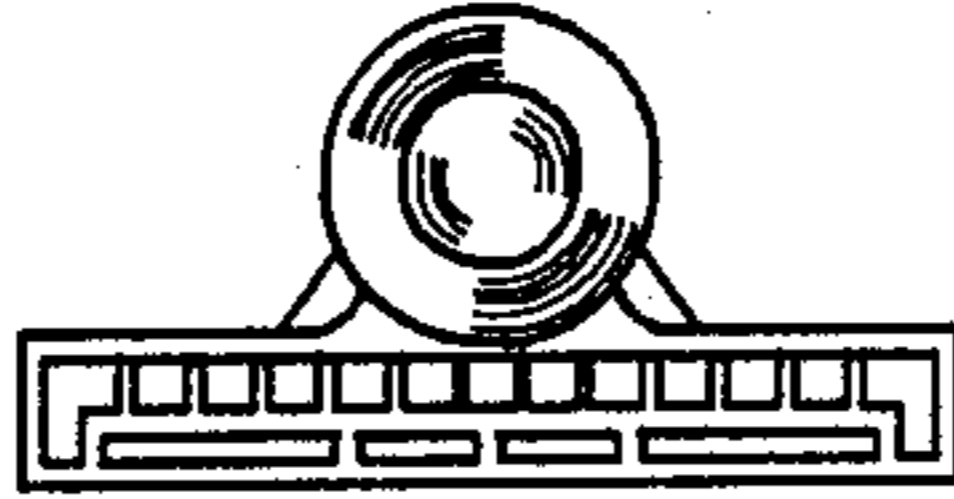

FIG. 5

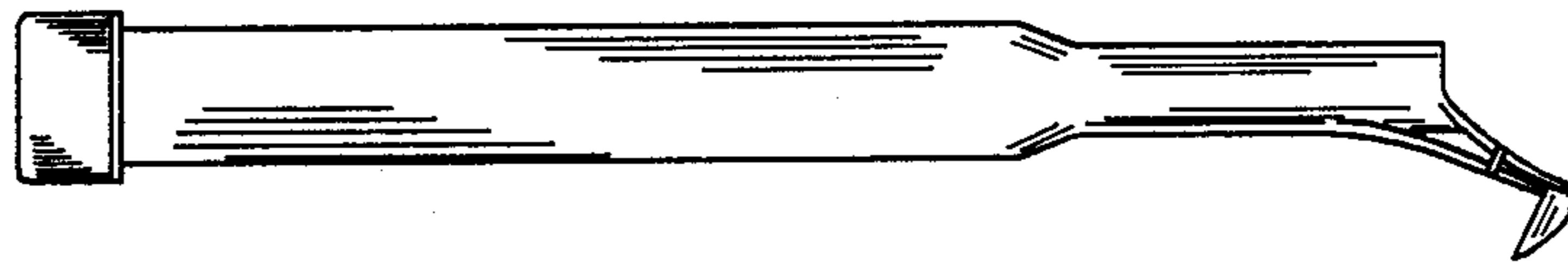

FIG. 6

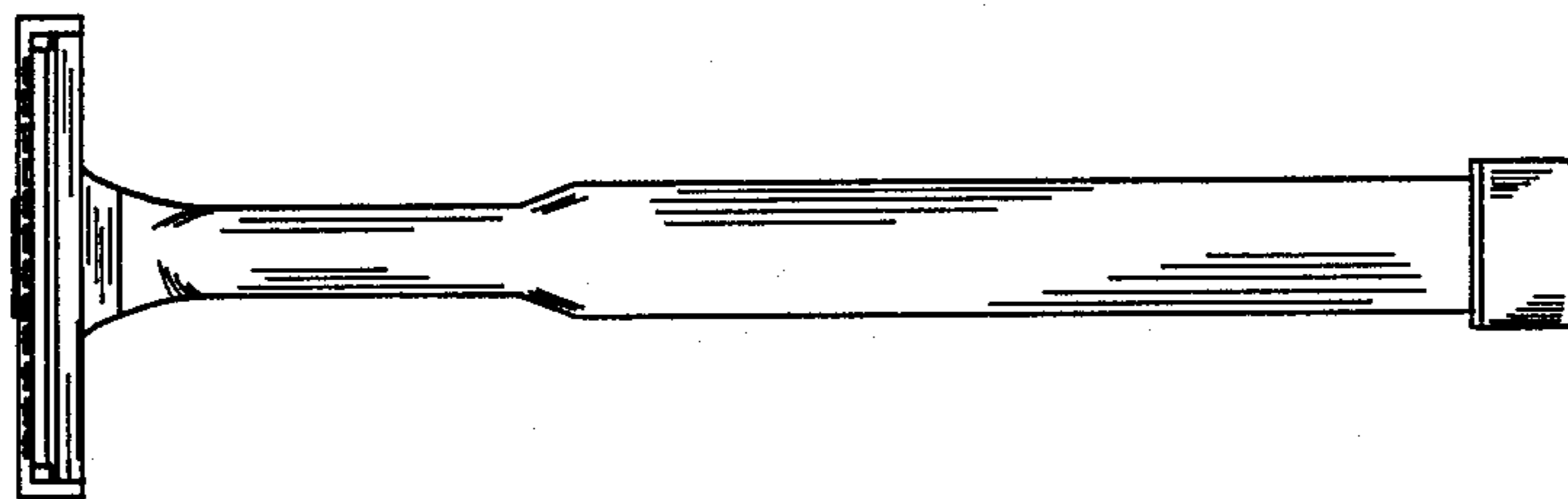

FIG. 7