

[54] SUPPORT FOR CANDLES, PLANTS, FLOWERS OR THE LIKE

[76] Inventors: David M. F. Chan, 1213 King Dr., El Cerrito, Calif. 94530; Michael L. F. Chan, 1407 Arch St., Berkeley, Calif. 94708

[**] Term: 14 Years

[21] Appl. No.: 177,014

[22] Filed: Apr. 4, 1988

[52] U.S. Cl. D6/513

[58] Field of Search D6/512-513, D6/403; 211/13, 113, 115, 119; 248/317-318; 47/66-67; 431/291, 296; D26/9-10, 13, 20, 22

[56] References Cited

U.S. PATENT DOCUMENTS

D. 275,432	9/1984	Chan et al.	D6/513
D. 301,947	7/1989	Chan et al.	D6/514 X
4,603,507	8/1986	Nelson	47/67

Primary Examiner—Wallace R. Burke
Assistant Examiner—Brian N. Vinson
Attorney, Agent, or Firm—Robert R. Tipton

[57] CLAIM

The ornamental design for a support for candles, plants, flowers or the like, as shown.

DESCRIPTION

FIG. 1 is a front elevational view of a support for candles, plants, flowers or the like showing our new design; FIG. 2 is a right side elevational view thereof; FIG. 3 is a rear elevational view thereof; FIG. 4 is a left side elevational view thereof; FIG. 5 is a top plan view thereof; and FIG. 6 is a bottom plan view thereof.

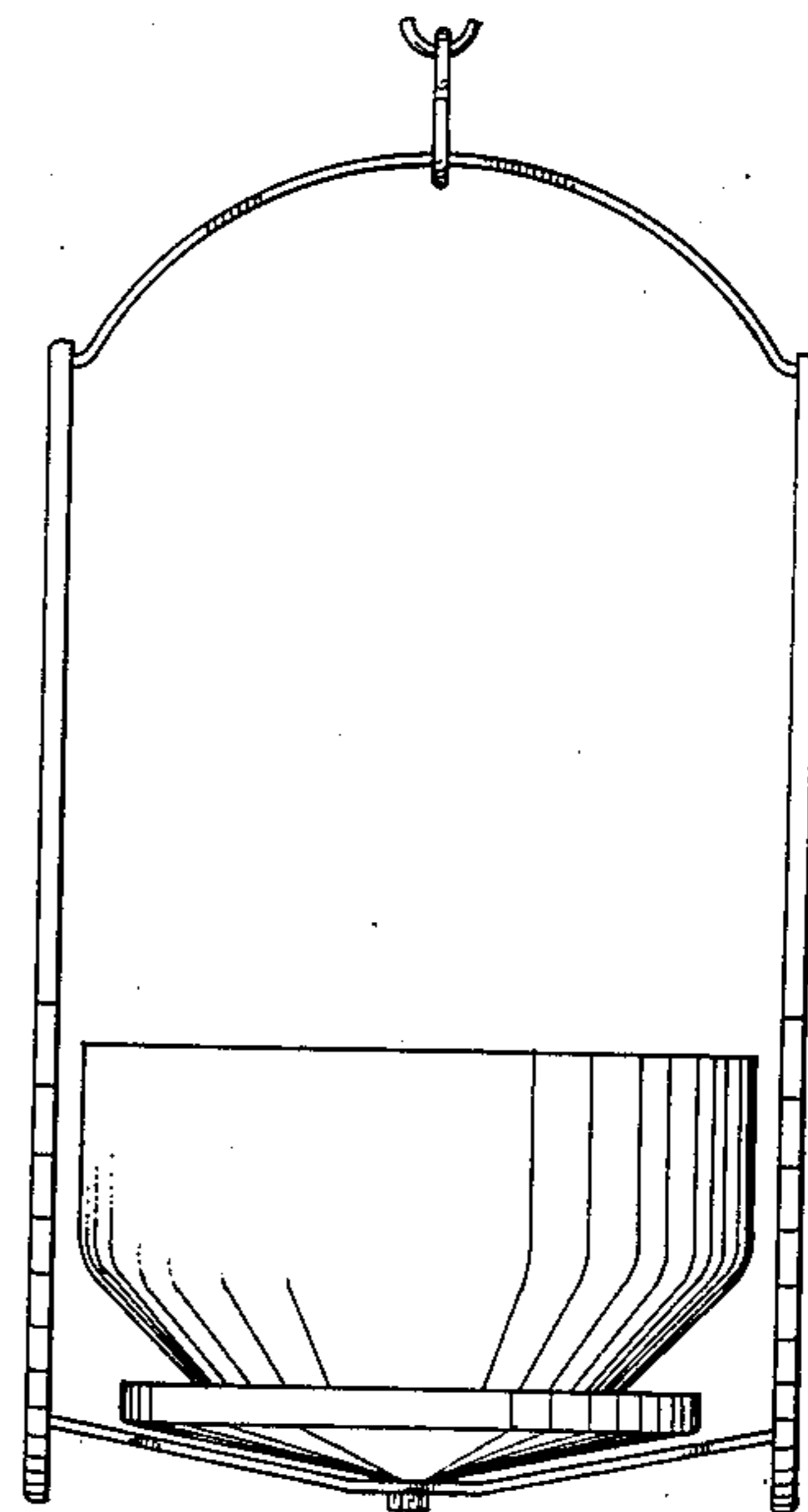
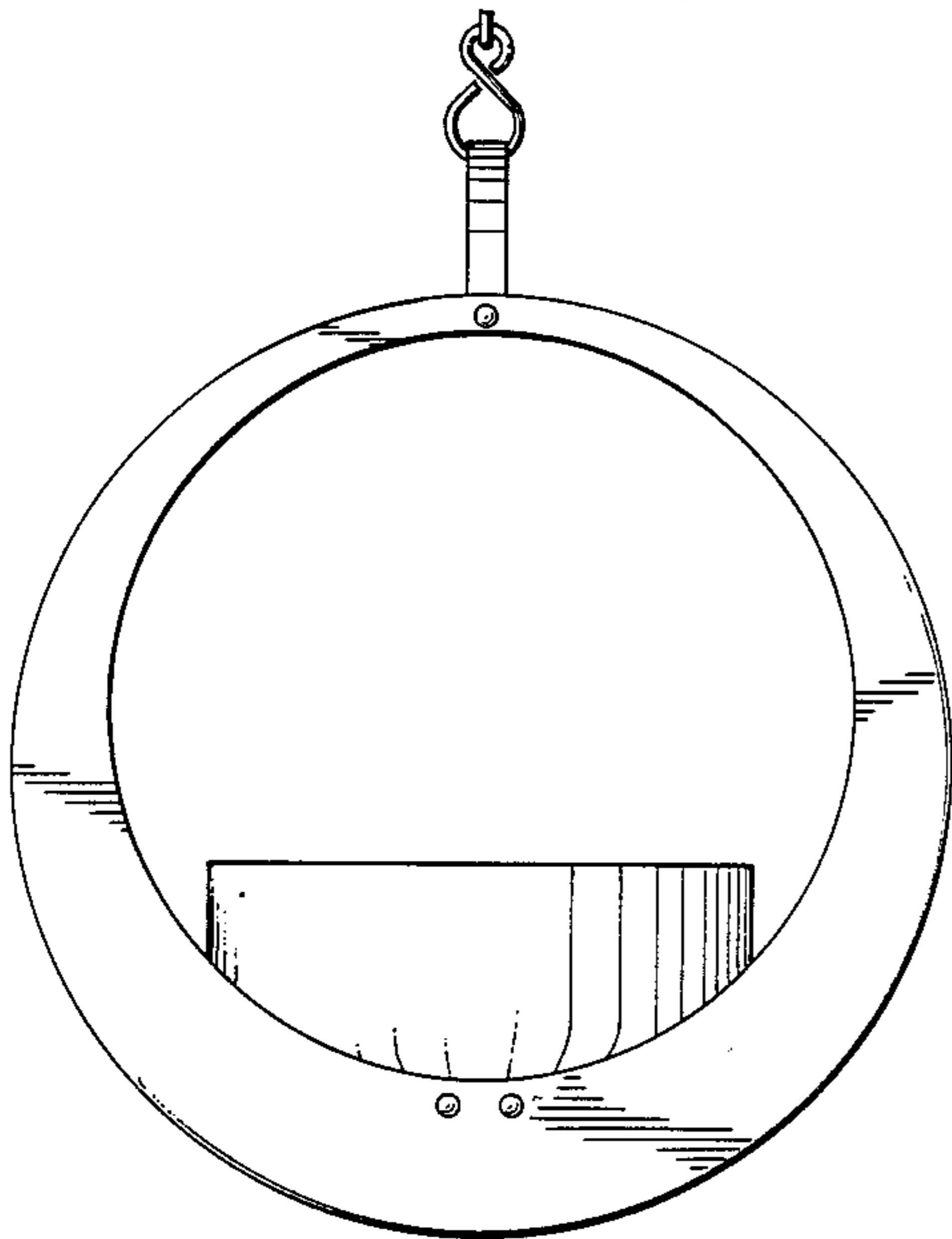

FIG. 1

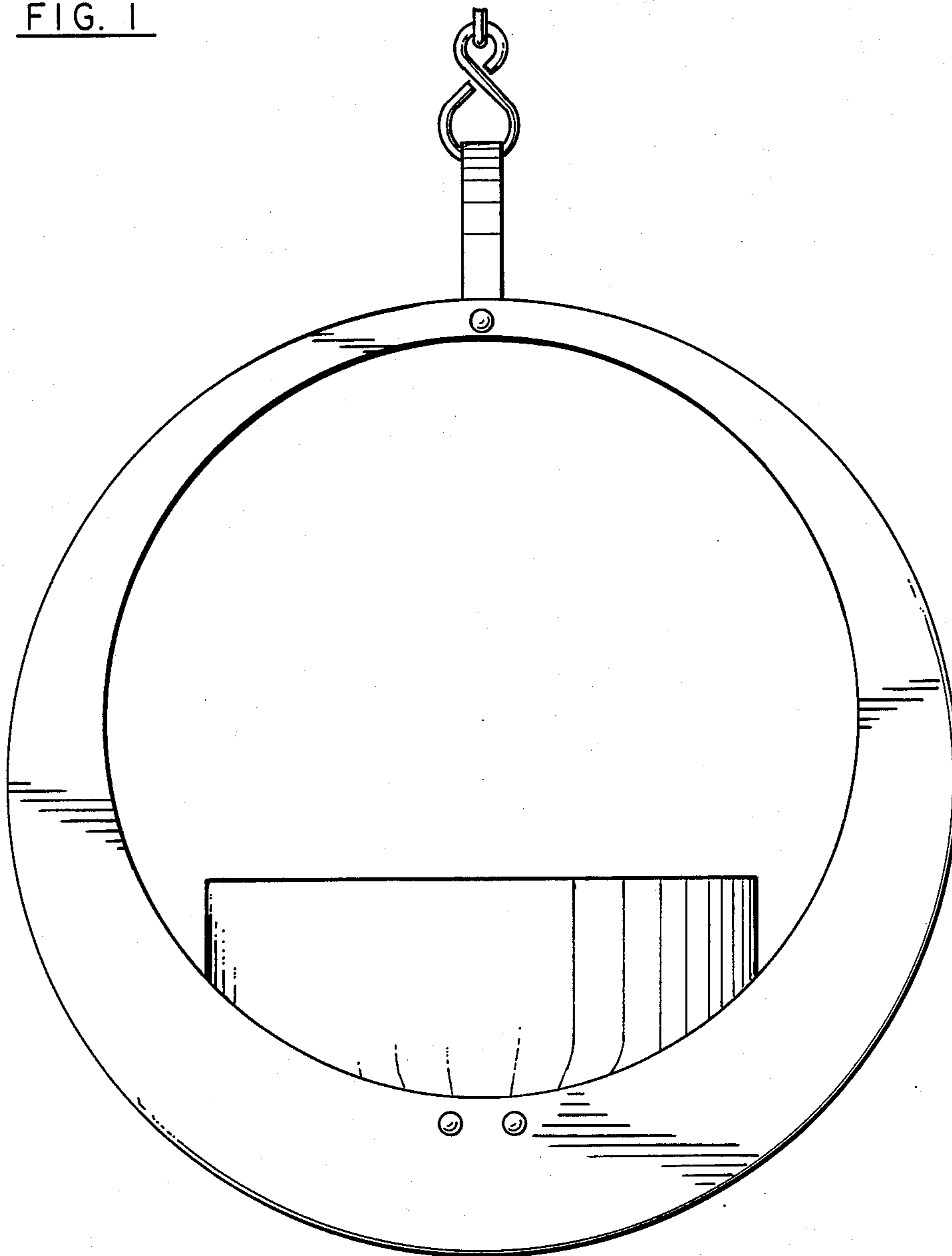

FIG. 2

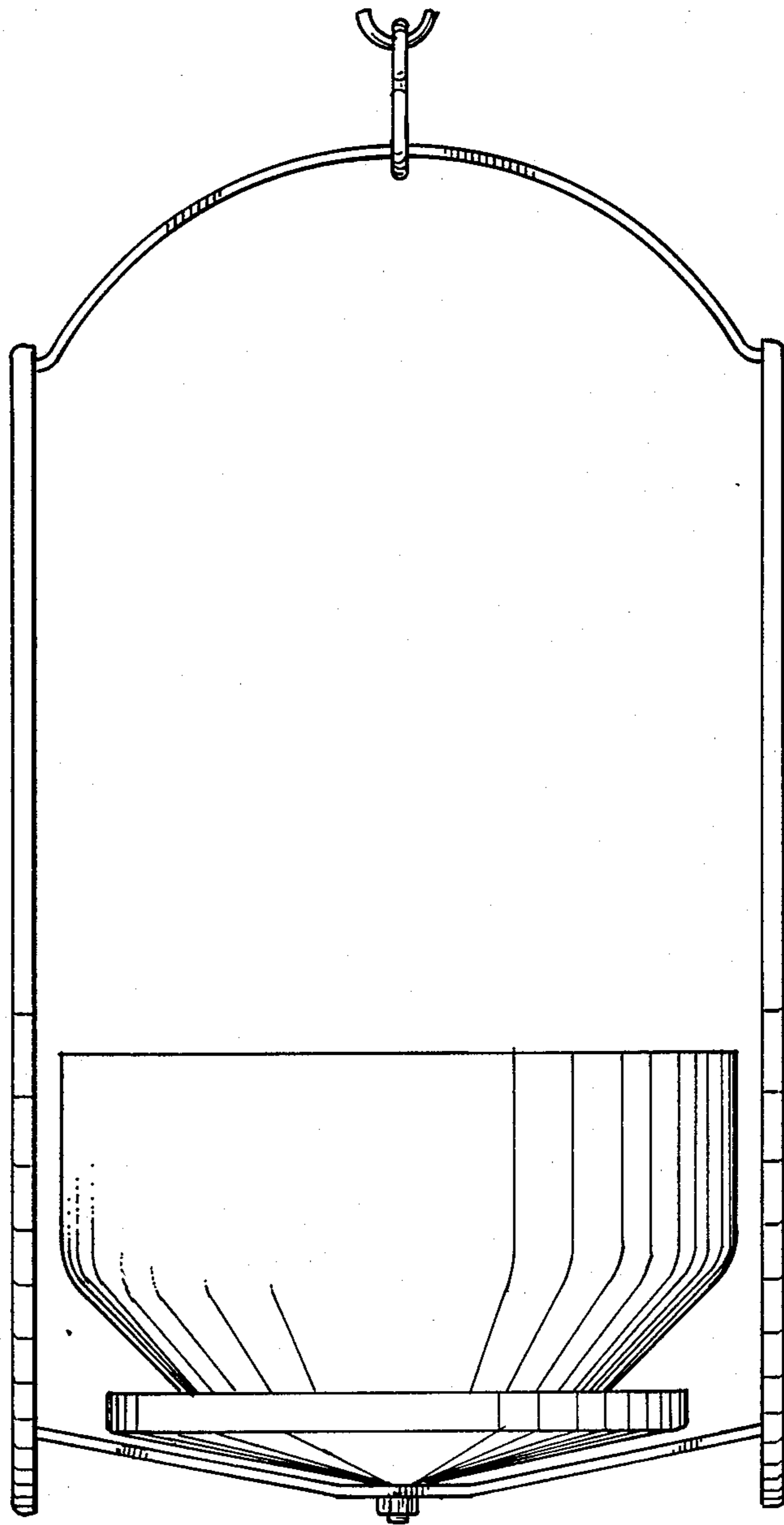

FIG. 3

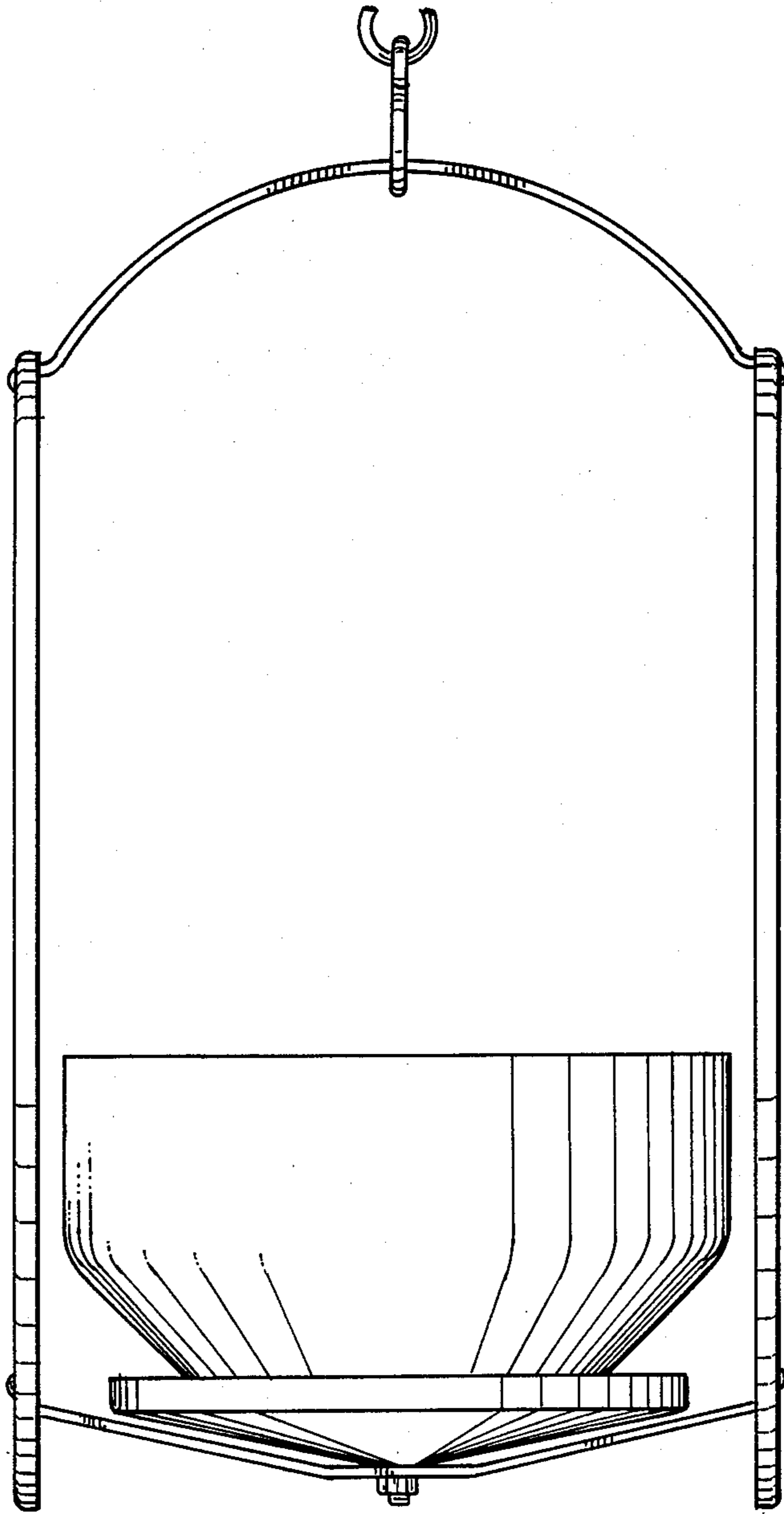

FIG. 4

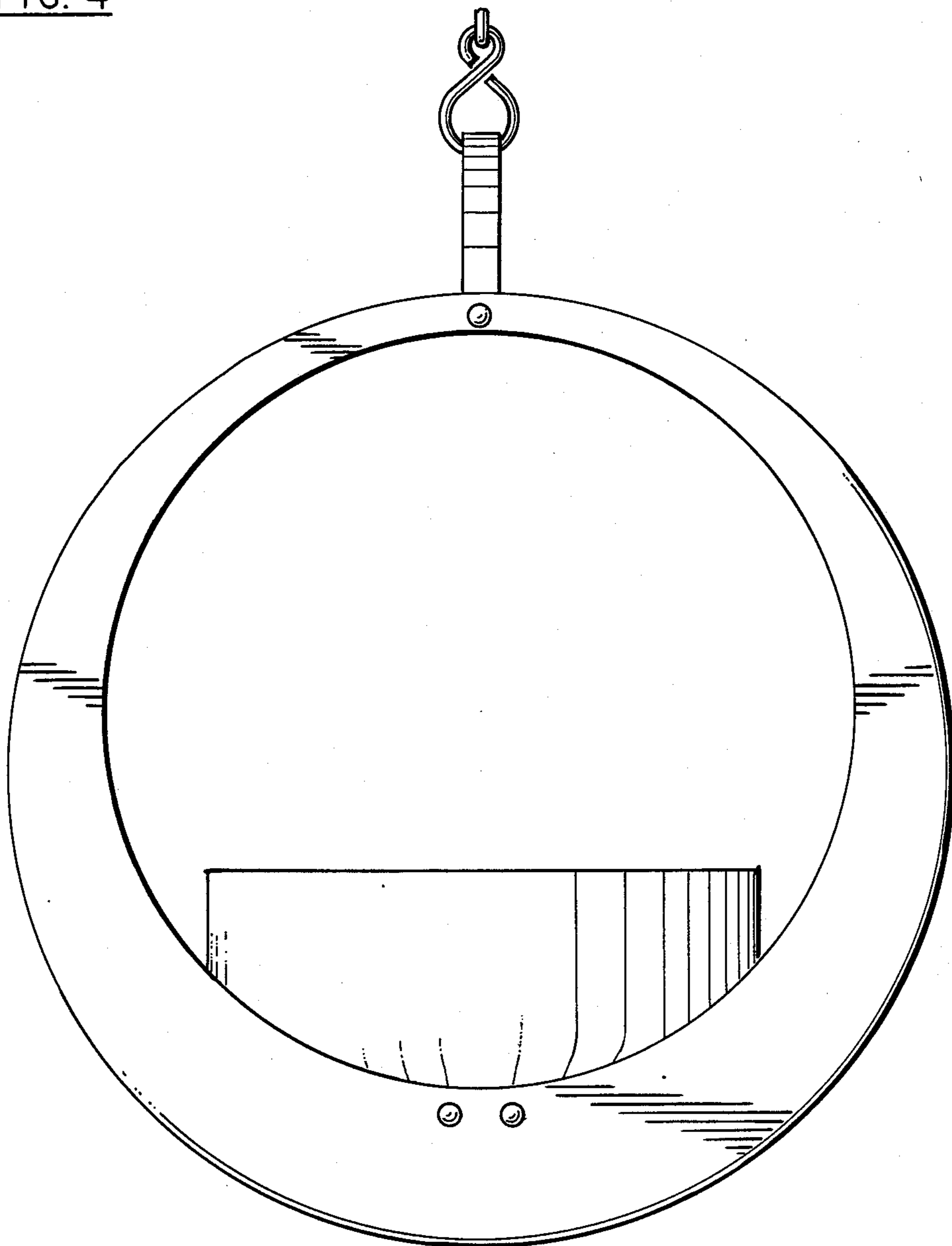

FIG. 5

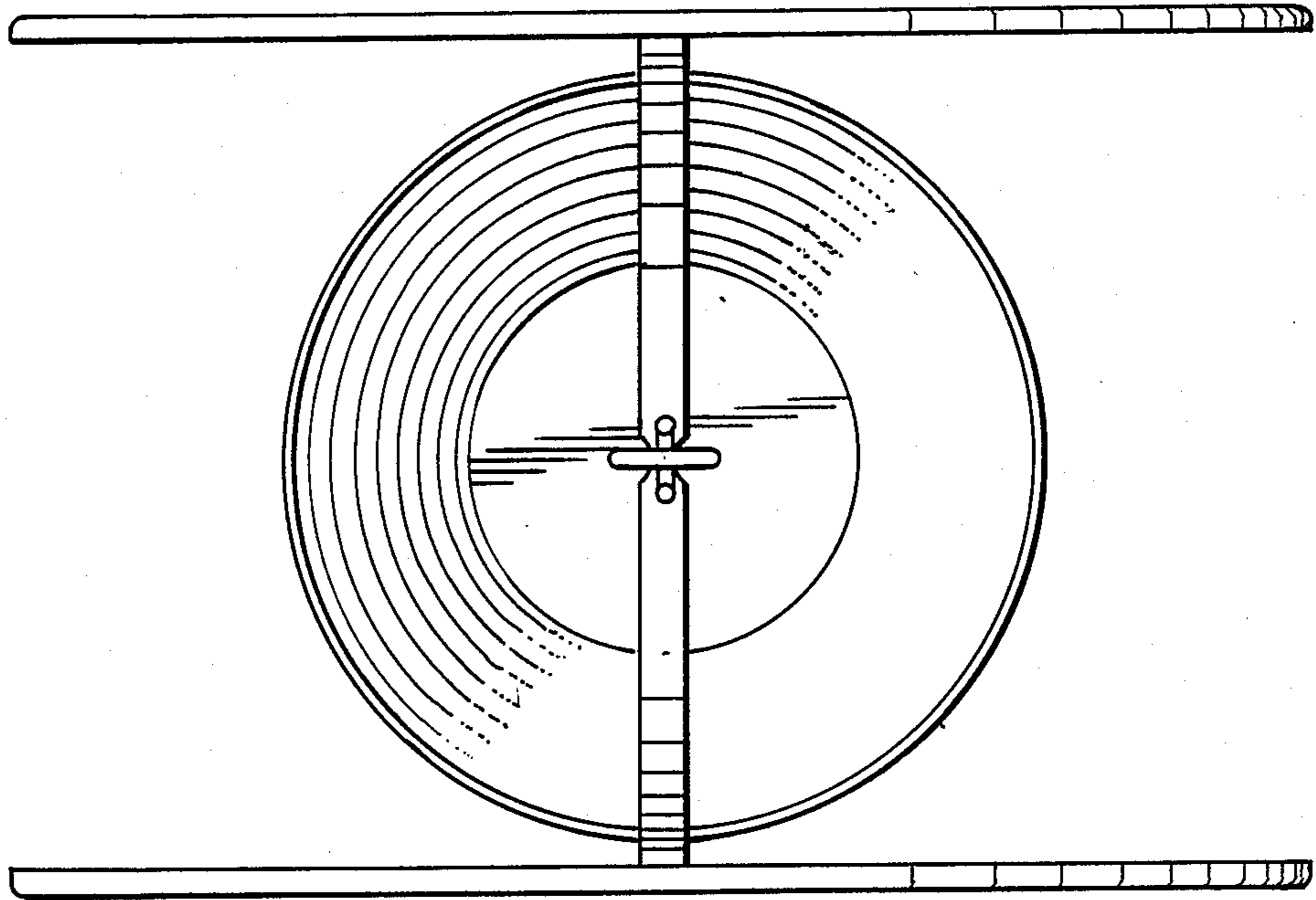

FIG. 6

