

[54] DISPLAY RACK

[75] Inventors: Brian F. Larson, Lake Zurich; Robert O'Neil, Glen Ellyn, both of Ill.

[73] Assignee: Fellowes Manufacturing Co., Itasca, Ill.

[\*\*] Term: 14 Years

[21] Appl. No.: 34,266

[22] Filed: Apr. 3, 1987

[52] U.S. Cl. .... D6/462

[58] Field of Search ..... D6/317, 332, 396, 397, D6/449, 462, 463, 464, 473, 474, 509, 511, 552; 211/134, 181, 187, 189, 194

[56] References Cited

U.S. PATENT DOCUMENTS

D. 106,230	9/1937	Fawcett	.....	211/59.1 X
D. 155,509	10/1949	Hertzberg	.....	D6/462
2,868,391	1/1959	Sides	.....	211/181
3,830,375	8/1974	Larson	.....	211/59.1
4,055,253	10/1977	Oztekin	.....	211/182 X
4,776,472	10/1988	Rosen	.....	211/187

OTHER PUBLICATIONS

Dynamic Displays, Inc., Nov. 1987, p. 2, Merchandisers

on upper left and lower right, Display Box X-1 (Display Hib).

Primary Examiner—Carmen H. Vales-Lado  
Assistant Examiner—Schon C. Oppert  
Attorney, Agent, or Firm—William Brinks Olds Hofer Gilson & Lione

[57] CLAIM

The ornamental design for a display rack, as shown and described.

DESCRIPTION

FIG. 1 is a top perspective view of the display rack showing our new design;  
FIG. 2 is a front elevational view thereof;  
FIG. 3 is a right side elevational view thereof;  
FIG. 4 is a left side elevational view thereof;  
FIG. 5 is a top plan view thereof;  
FIG. 6 is a rear elevational view thereof;  
FIG. 7 is a top perspective view of another embodiment of our display rack shown in FIG. 1;  
FIG. 8 is a front elevational view thereof;  
FIG. 9 is a right side elevational view, the left side view being a mirror image thereof;  
FIG. 10 is a top plan view thereof; and  
FIG. 11 is a rear elevational view thereof.

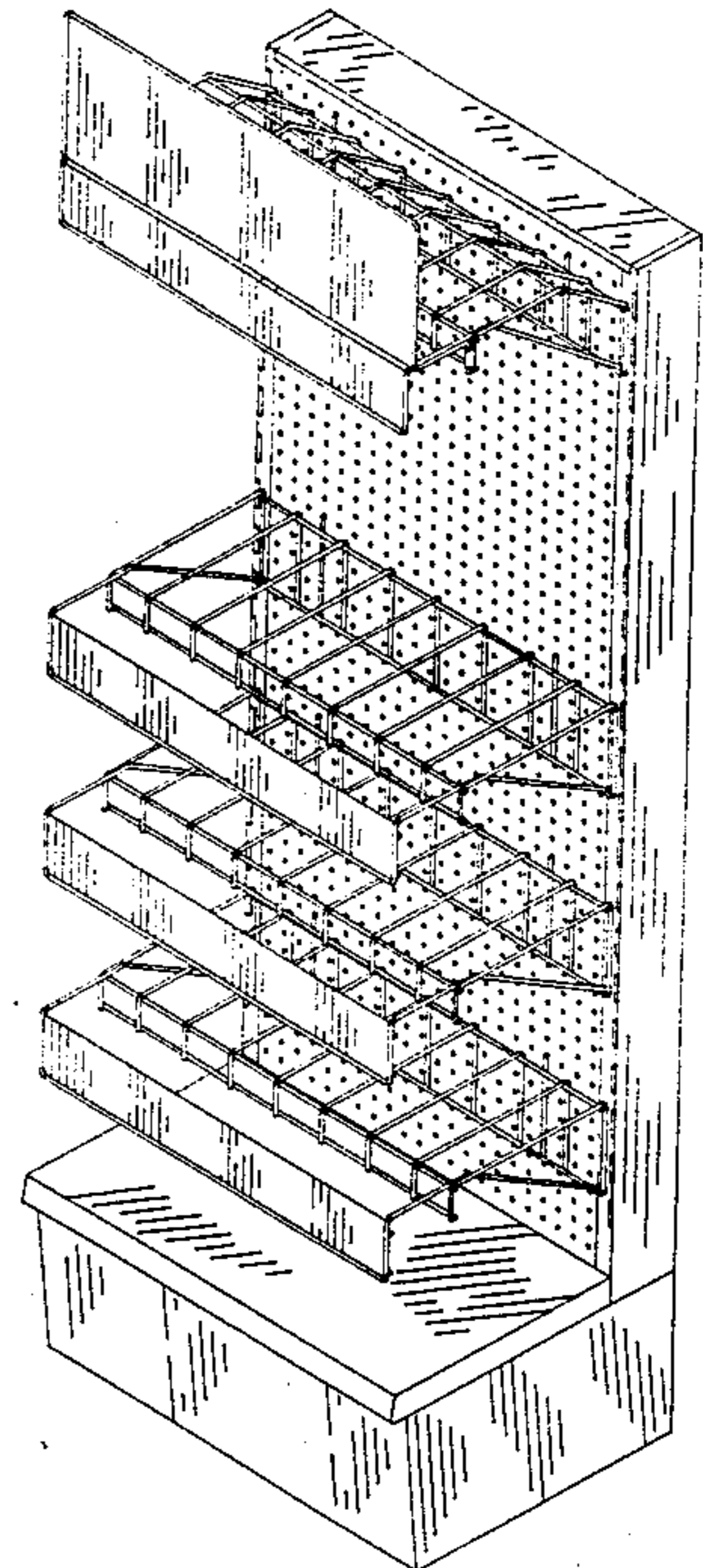
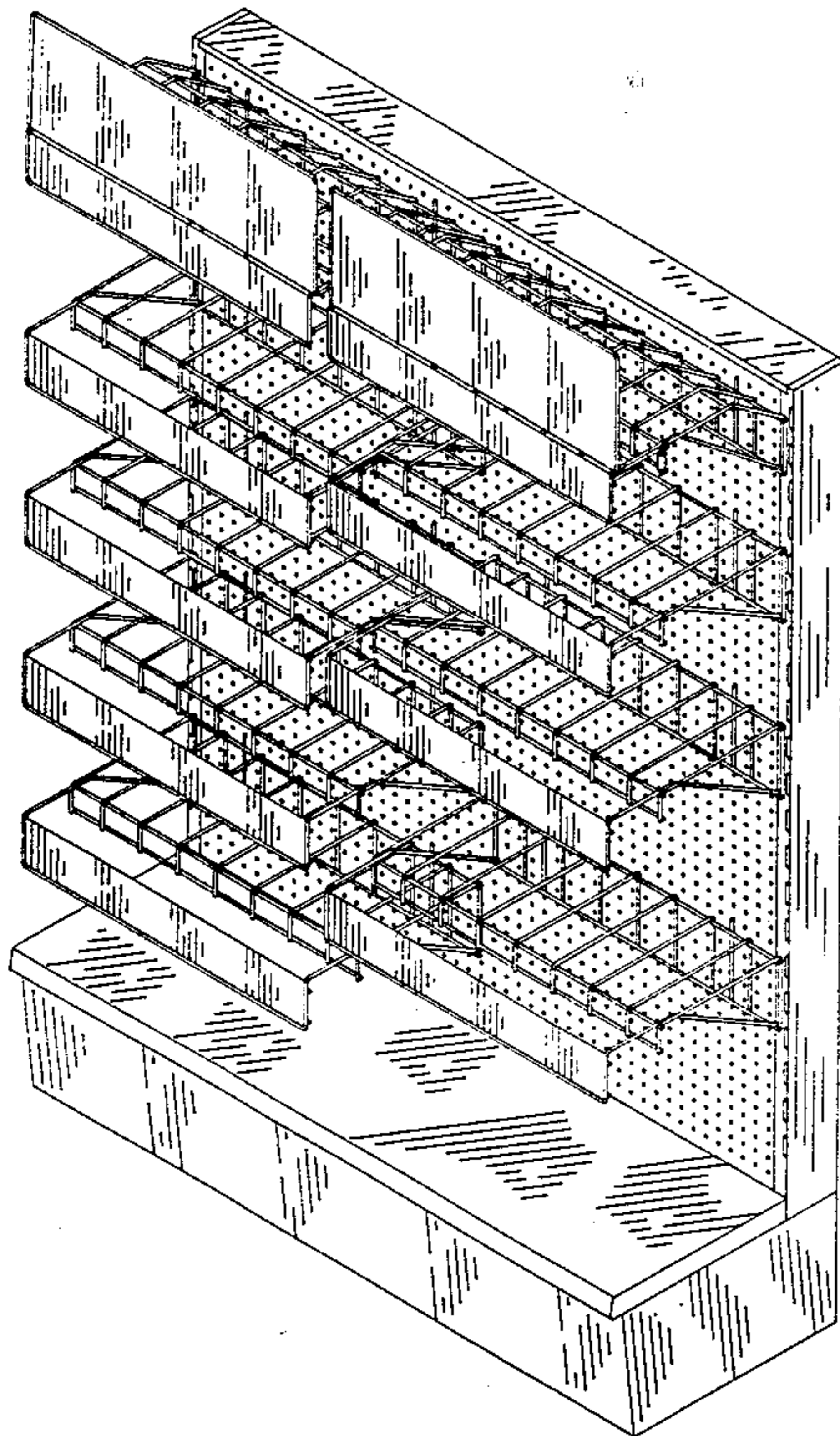

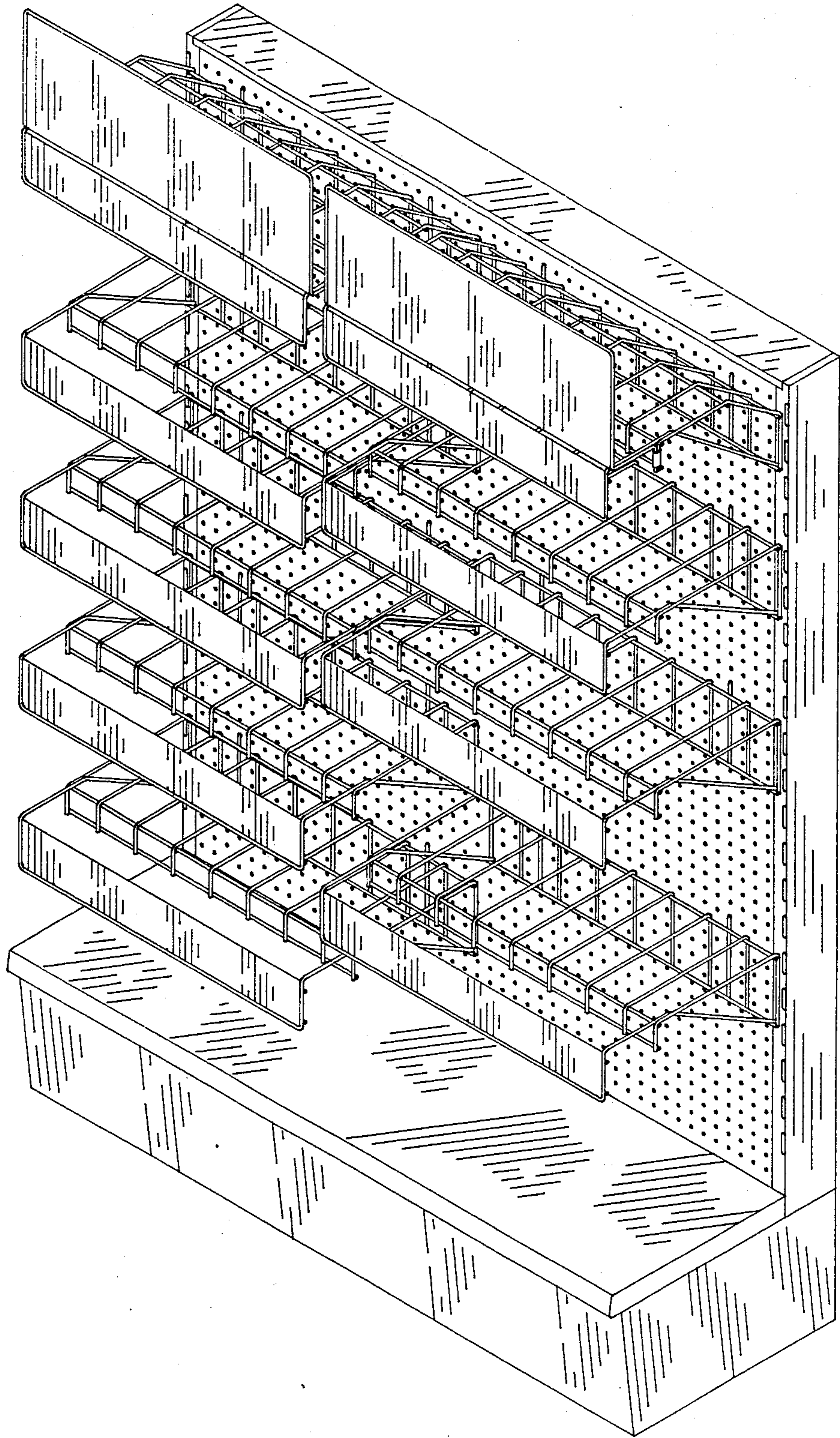

FIG. 1

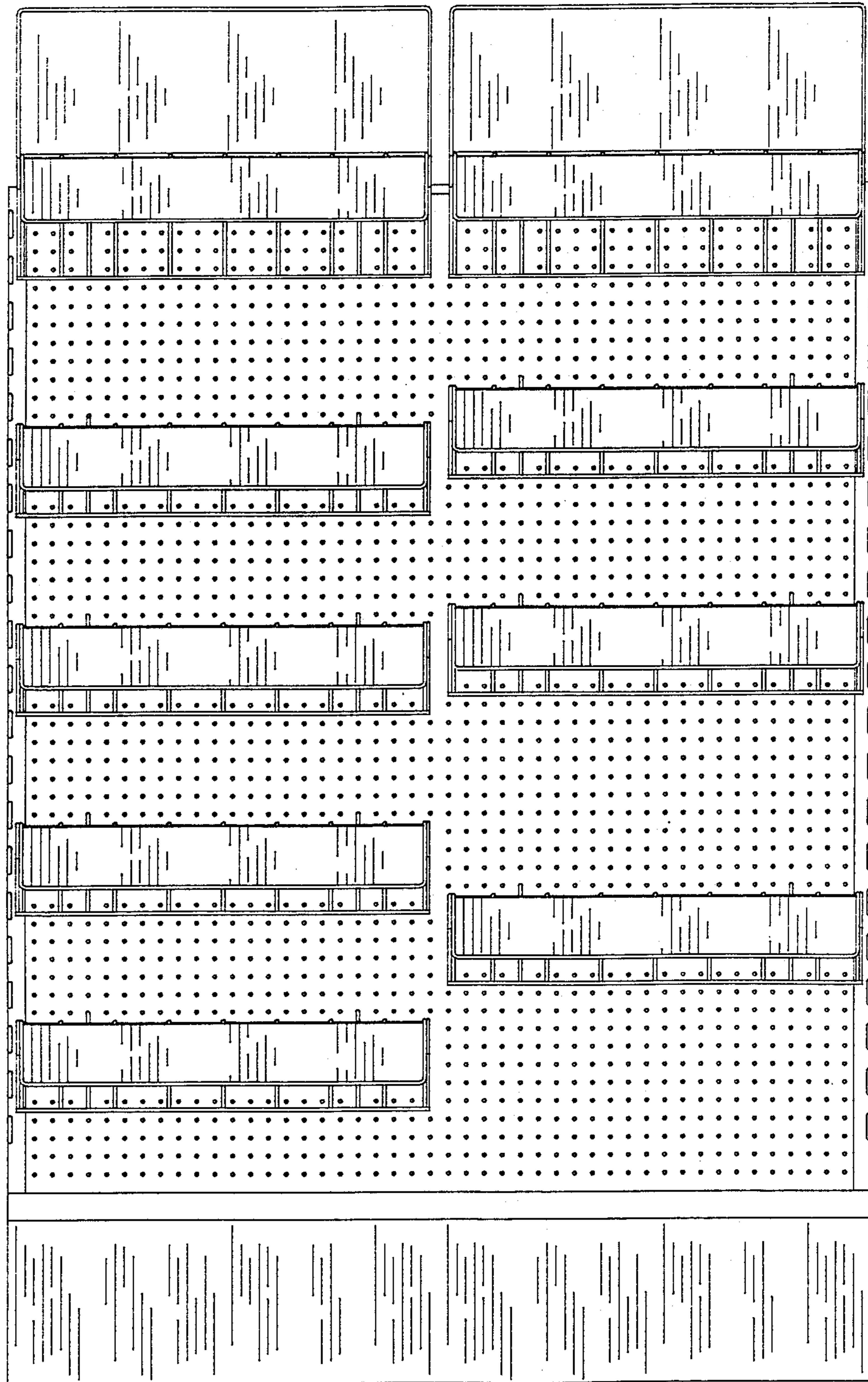

FIG. 2

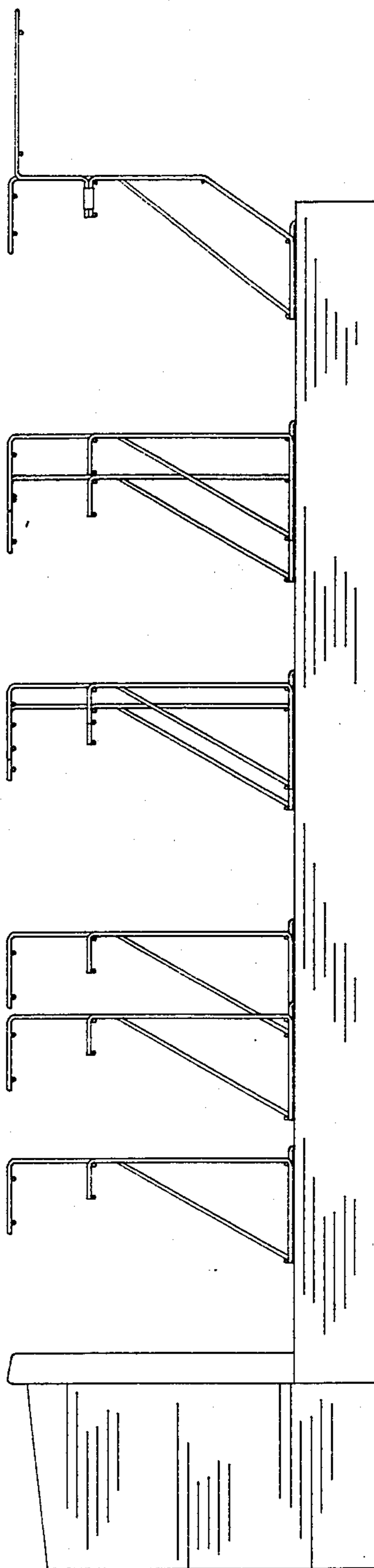

FIG. 3

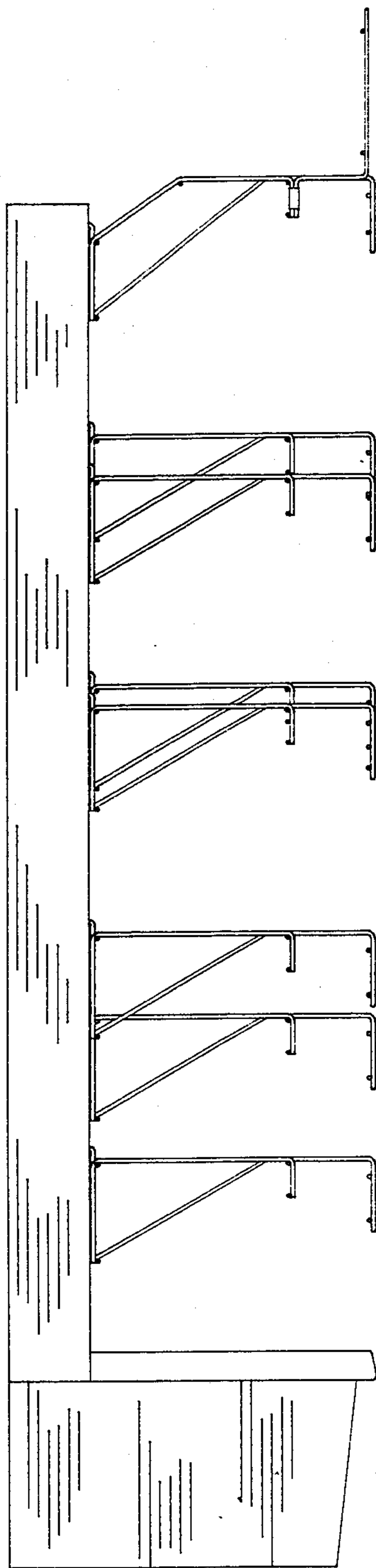

FIG. 4

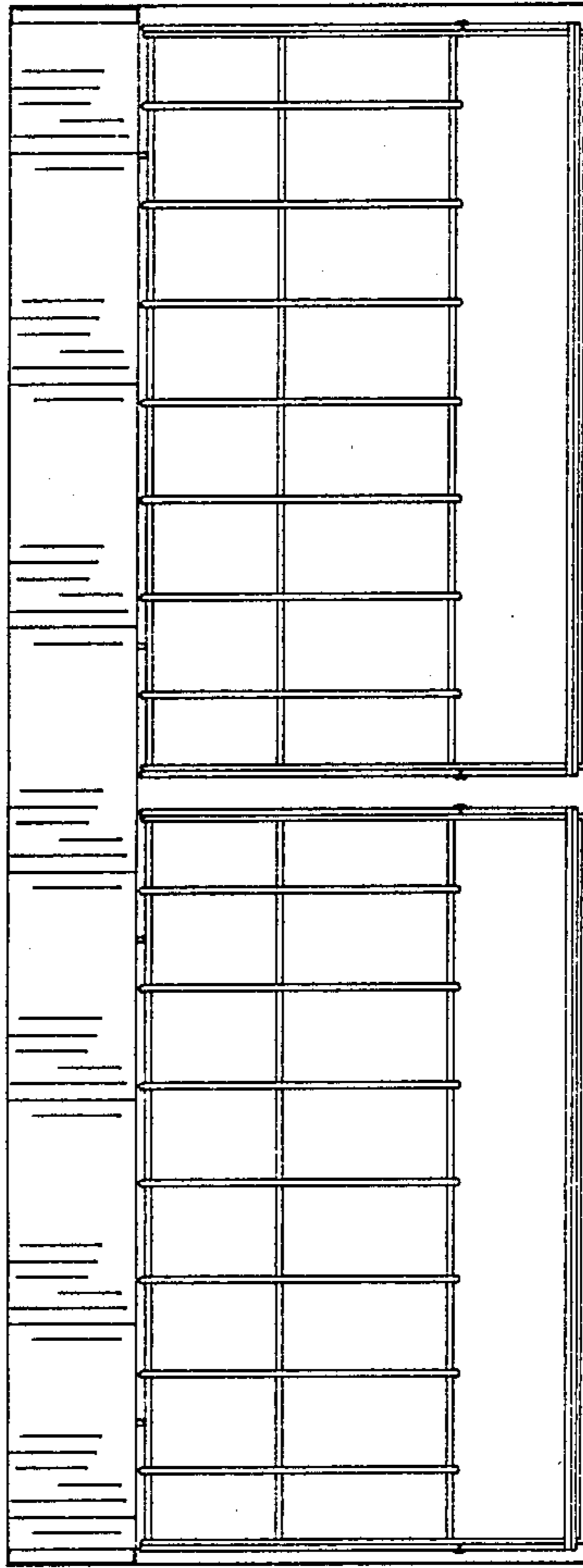

FIG. 5

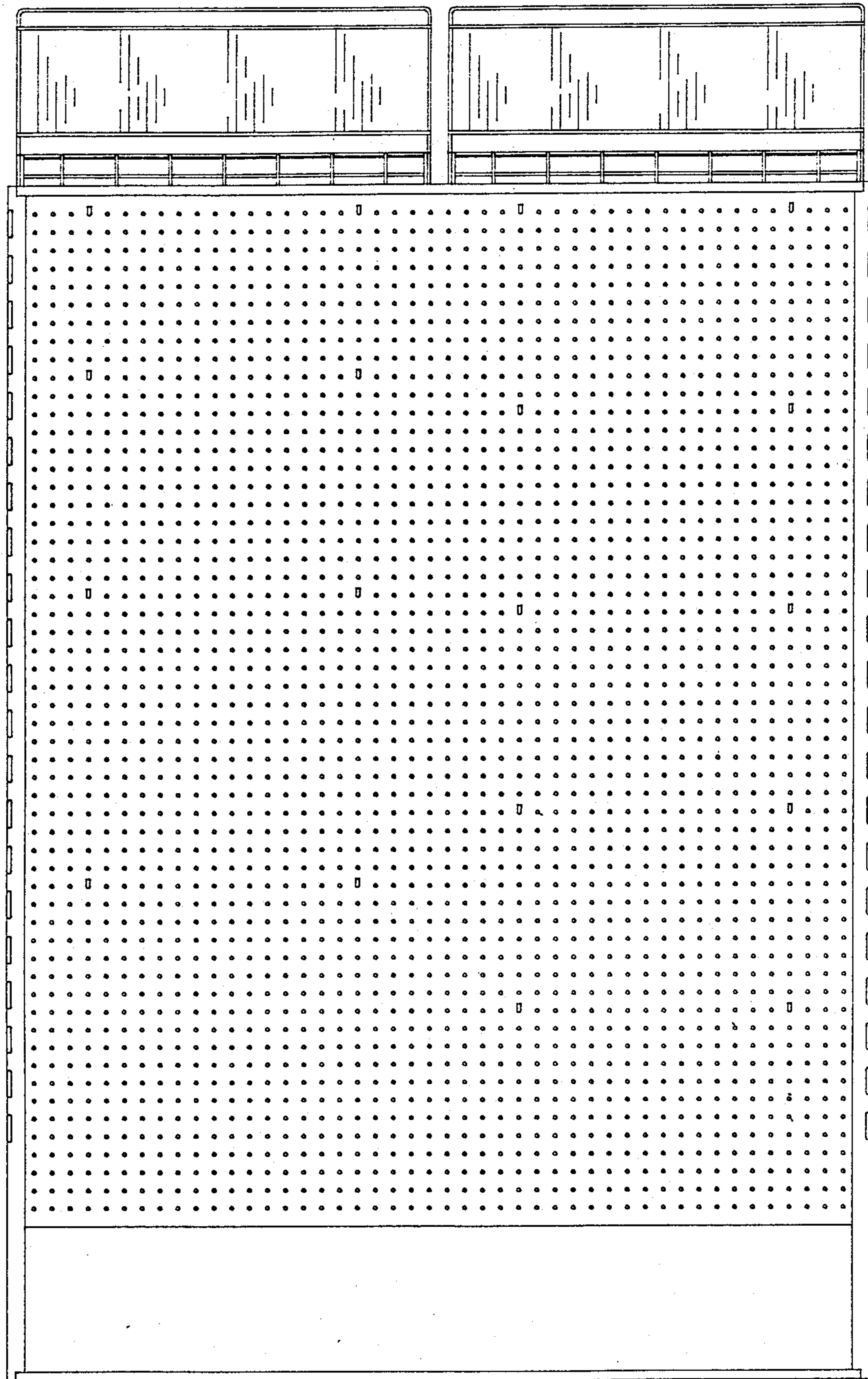

FIG. 6

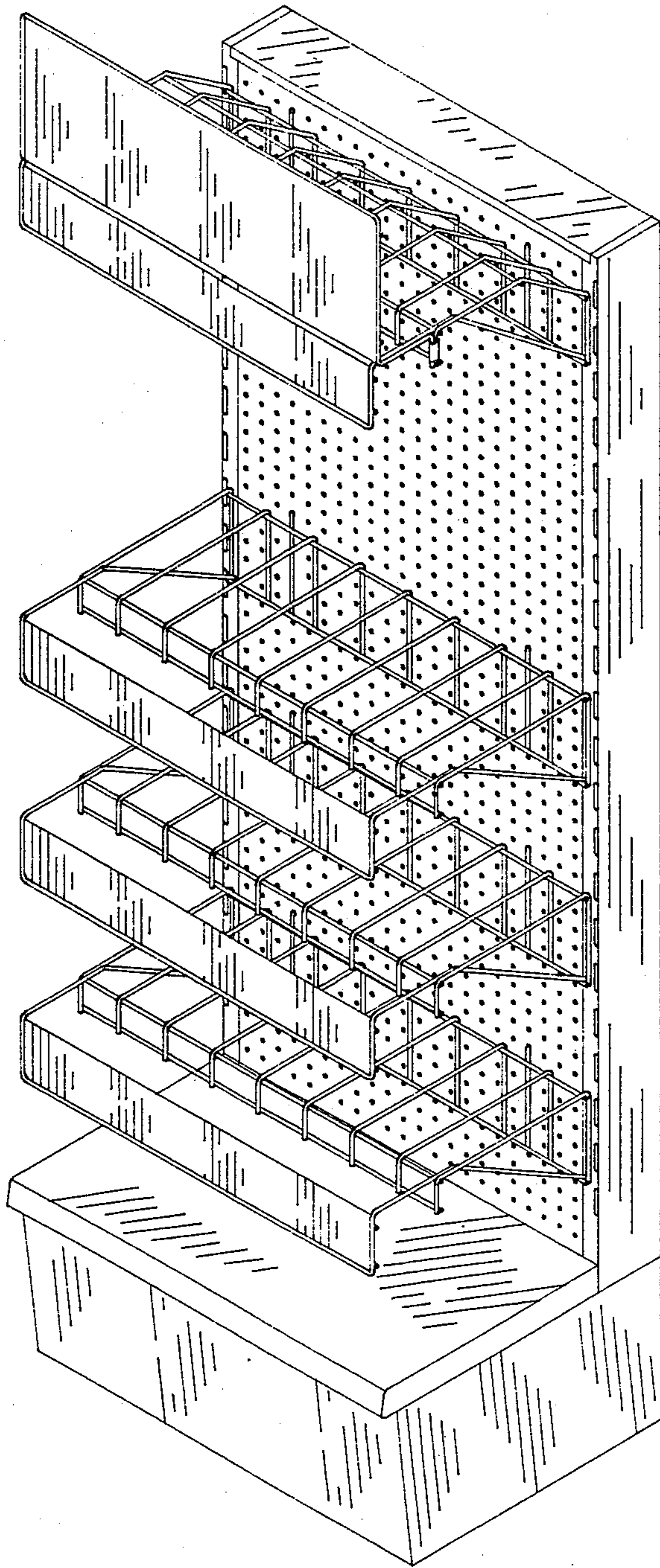

FIG. 7



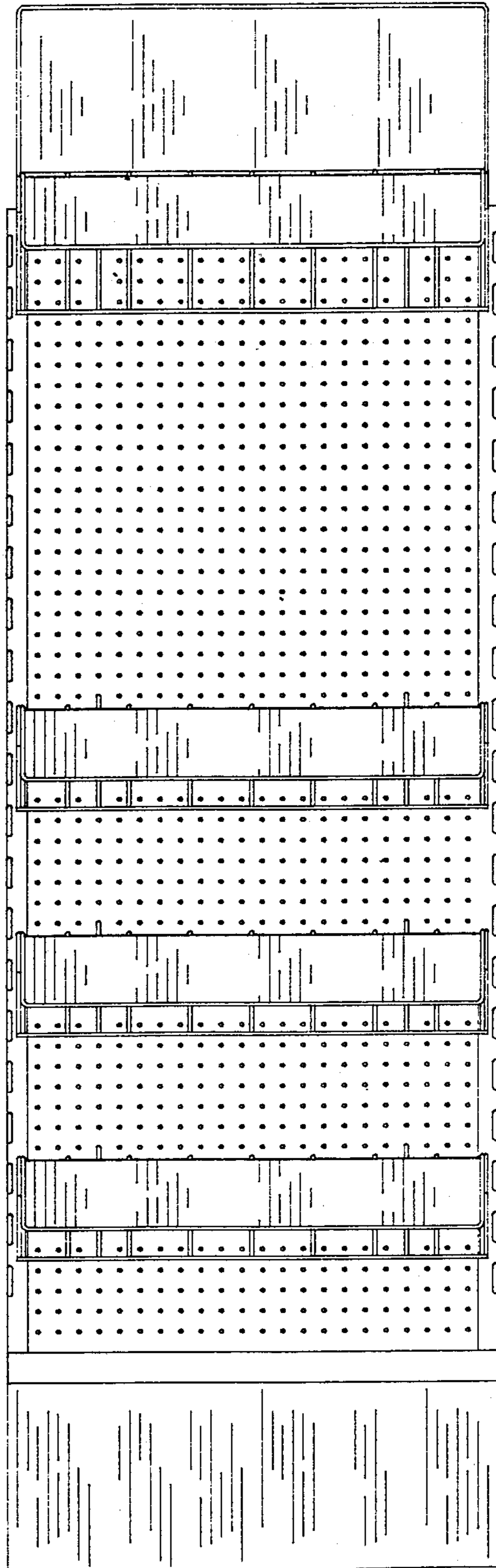

FIG. 8

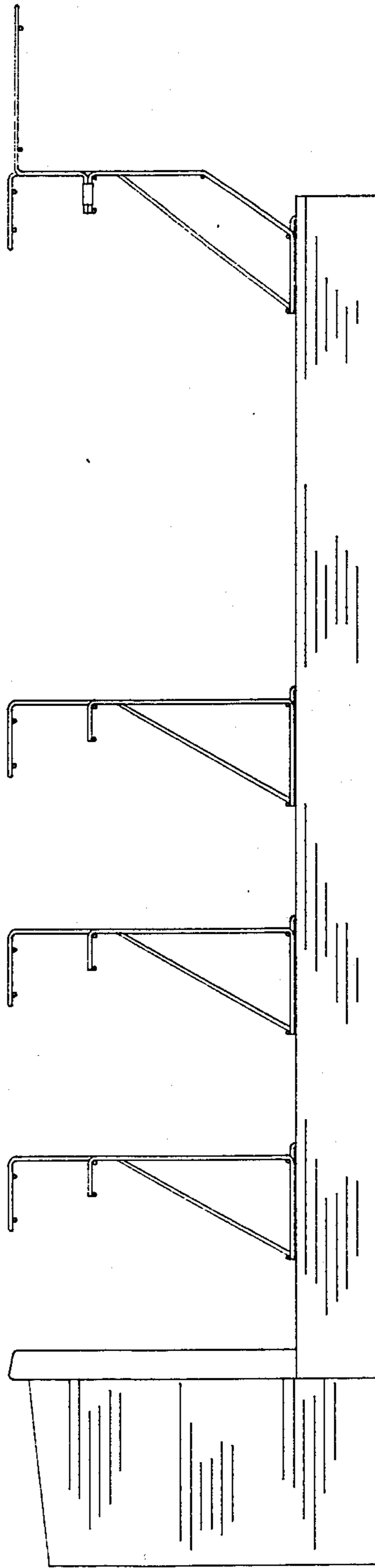

FIG. 9

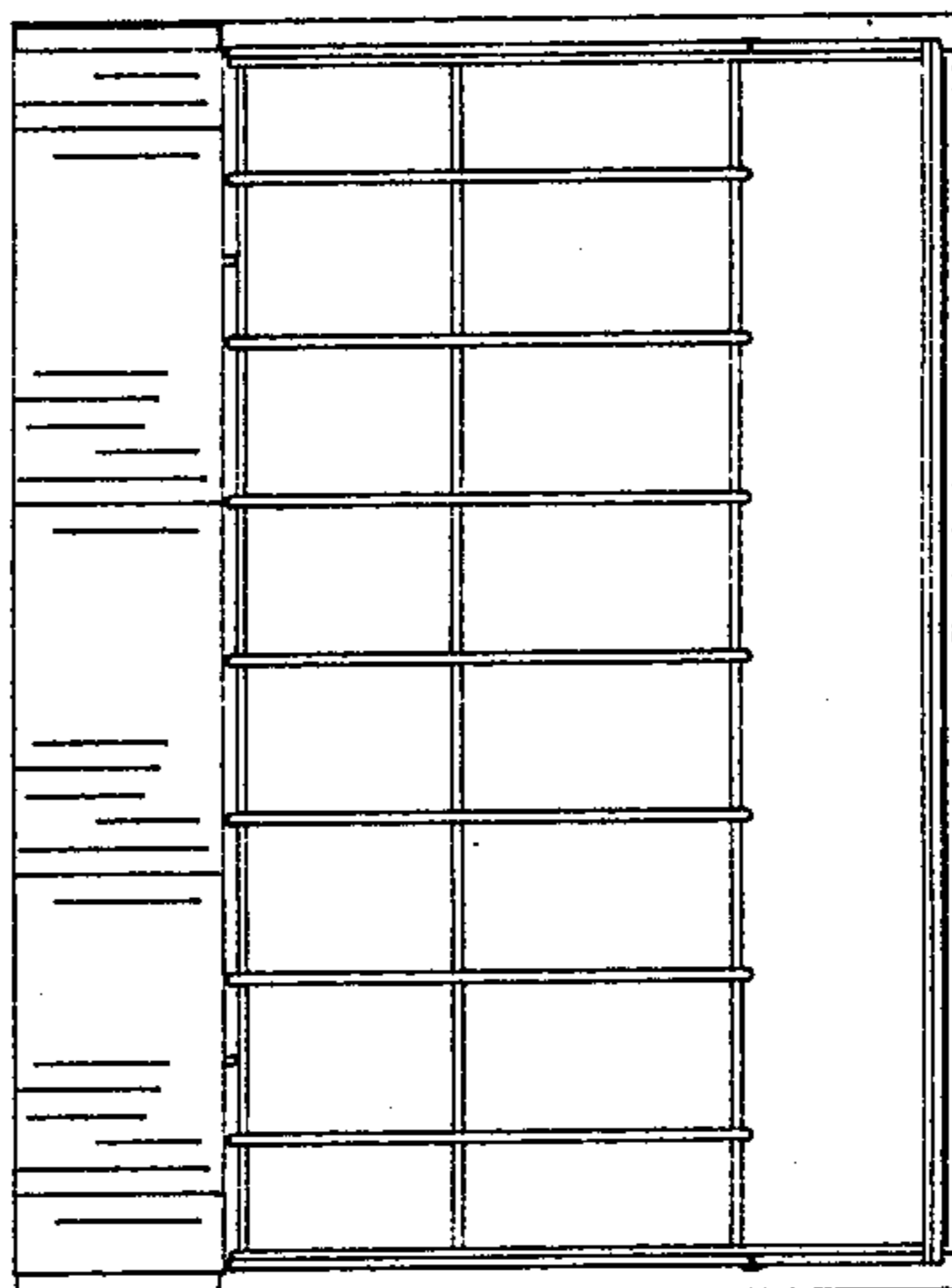

FIG. 10

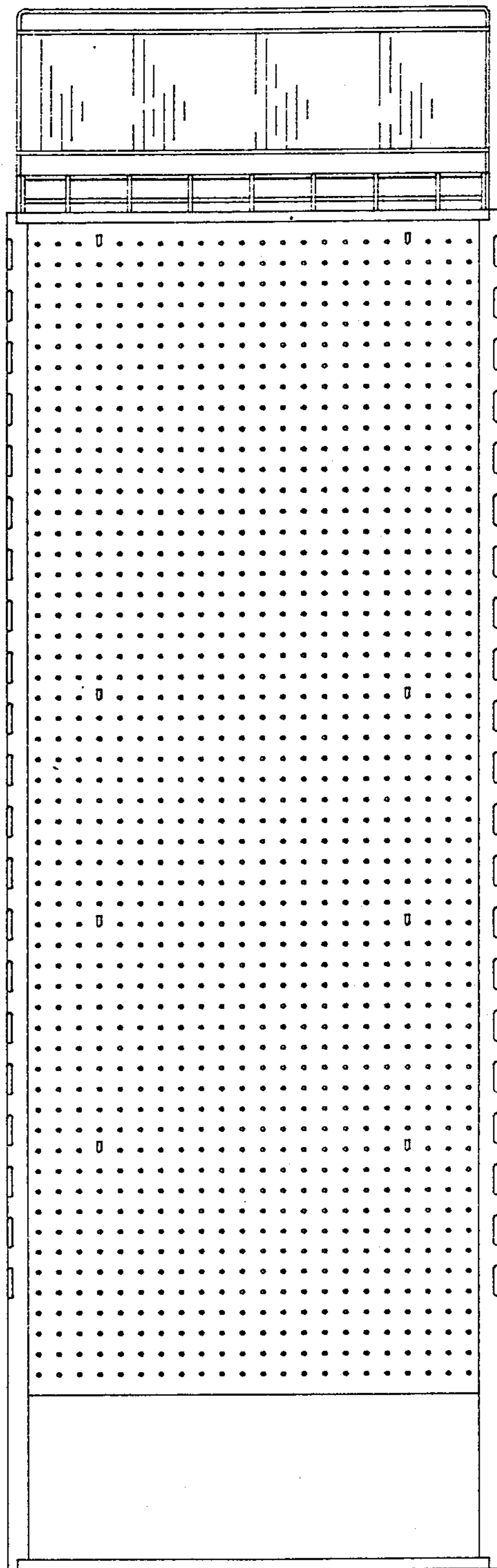

FIG. 11