

[54] ADJUSTABLE HIGH CHAIR

[75] Inventor: **Kenzou Kassai**, Osaka, Japan

[73] Assignee: **Aprica Kassai Kabushikikaisha**,
Osaka, Japan

[**] Term: **14 Years**

[21] Appl. No.: **932,895**

[22] Filed: **Nov. 18, 1986**

[52] U.S. Cl. **D6/339**

[58] Field of Search **D6/333, 335, 338, 339,**
D6/372, 373; 297/148, 149, 153, 55

[56] **References Cited**

U.S. PATENT DOCUMENTS

D. 184,192	12/1958	Peterson	D6/339
D. 288,868	3/1987	Saltzman et al.	D6/338
2,973,804	3/1961	Gill	297/
3,649,074	3/1972	McDonald et al.	297/153

Primary Examiner—Nelson C. Holtje
Assistant Examiner—Ann Hunt
Attorney, Agent, or Firm—W. G. Fasse; D. H. Kane, Jr.

[57] **CLAIM**

The ornamental design for an adjustable high chair, as shown and described.

DESCRIPTION

FIG. 1 is a front elevational view of an adjustable high chair showing my new design;
FIG. 2 is a rear elevational view thereof;
FIG. 3 is a top plan view thereof;
FIG. 4 is a bottom plan view thereof;
FIG. 5 is a left side elevational view thereof;
FIG. 6 is a right side elevational view thereof;
FIG. 7 is a front perspective view thereof;
FIG. 8 is a front perspective view of the adjustable high chair with the tray removed for convenience of illustration; and
FIG. 9 is a front perspective view of the adjustable high chair showing the adjustable seat in a lower position.

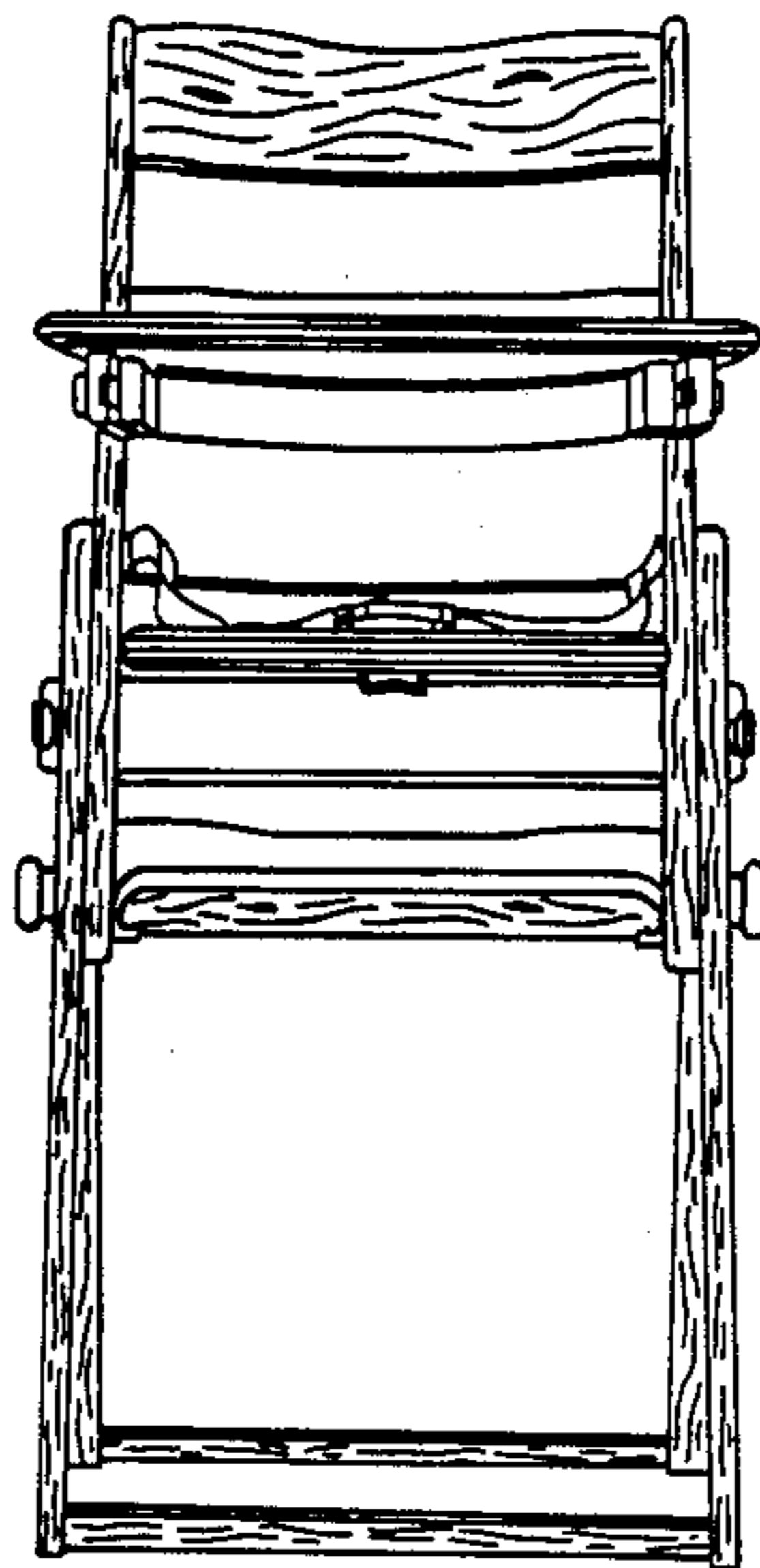

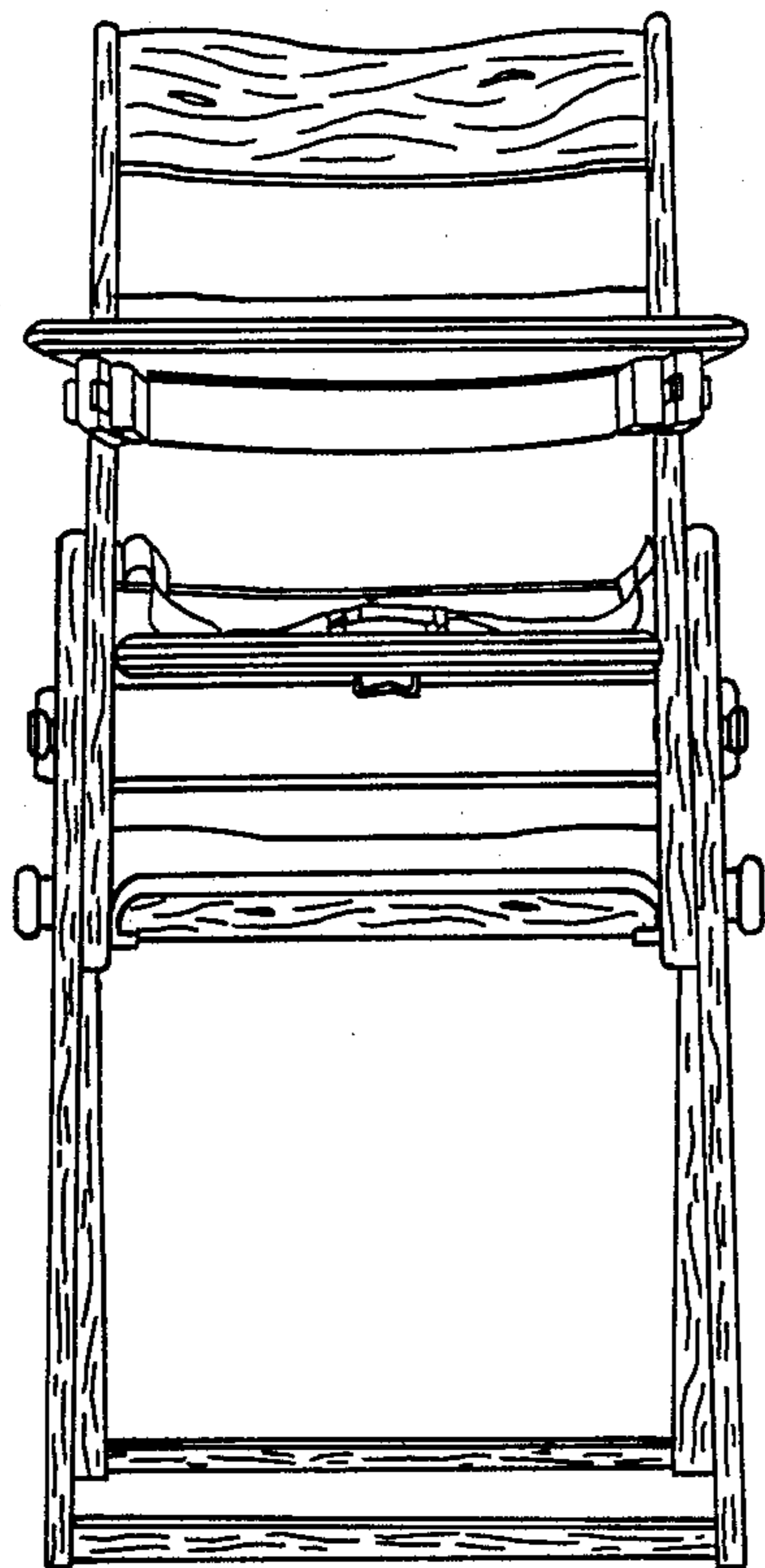

FIG. 1

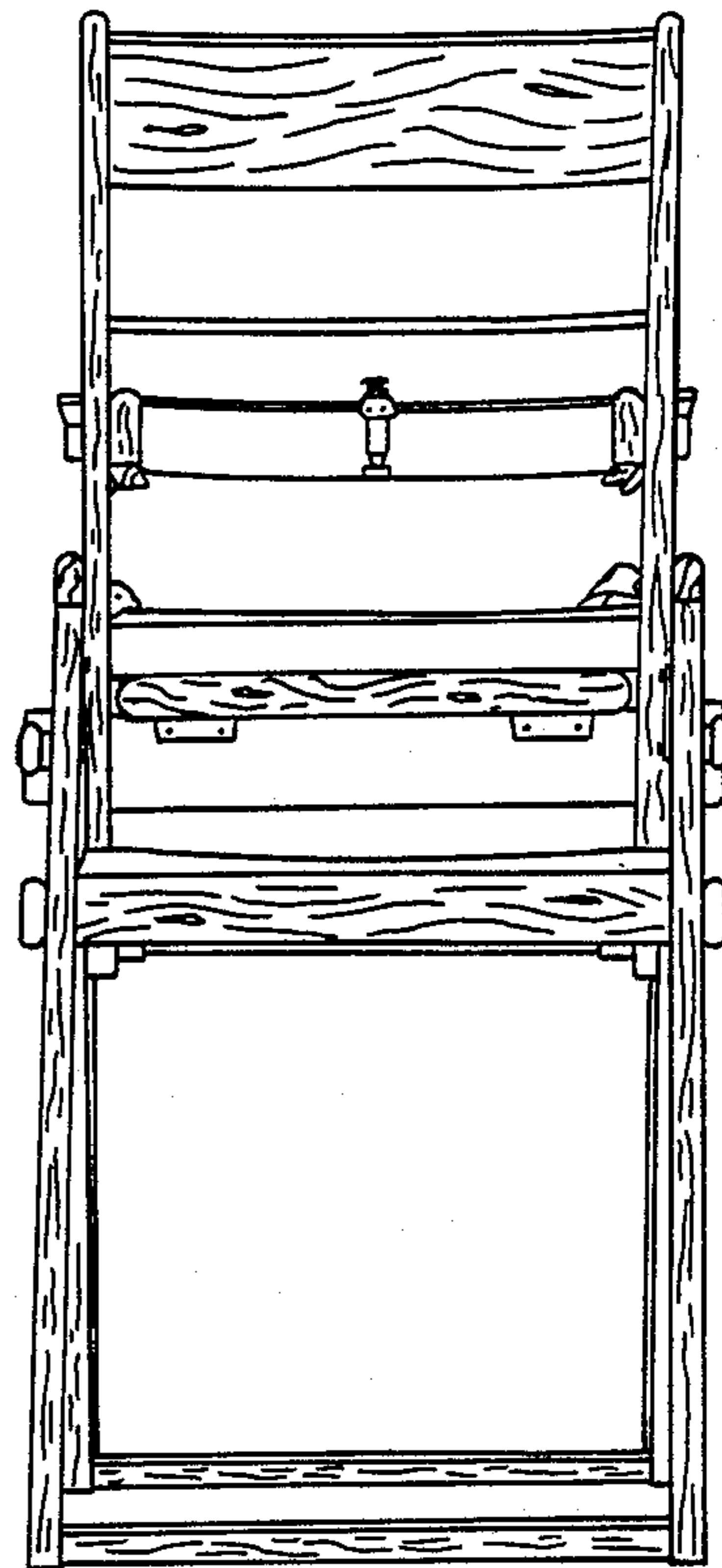
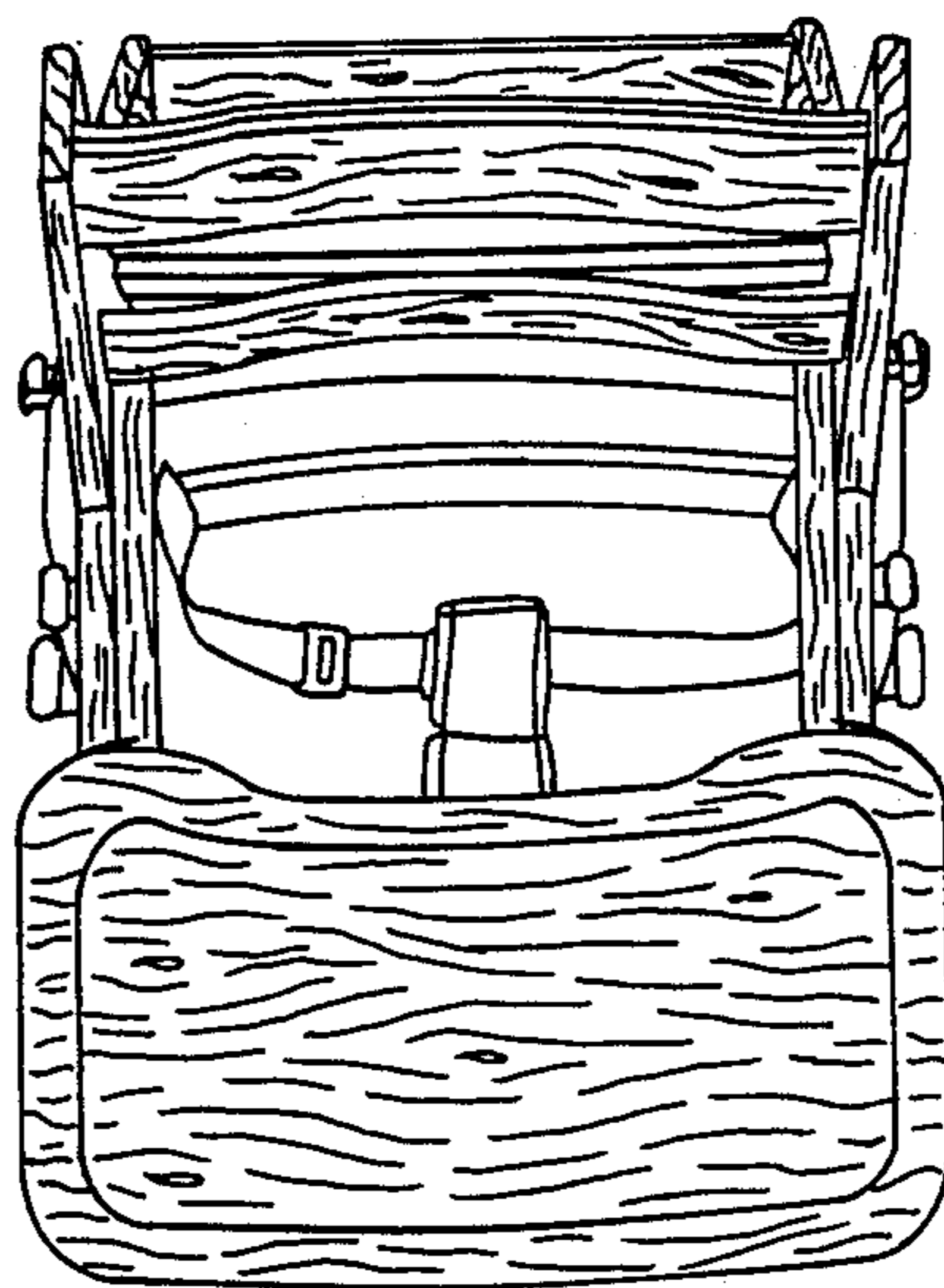

FIG. 2

FIG. 3



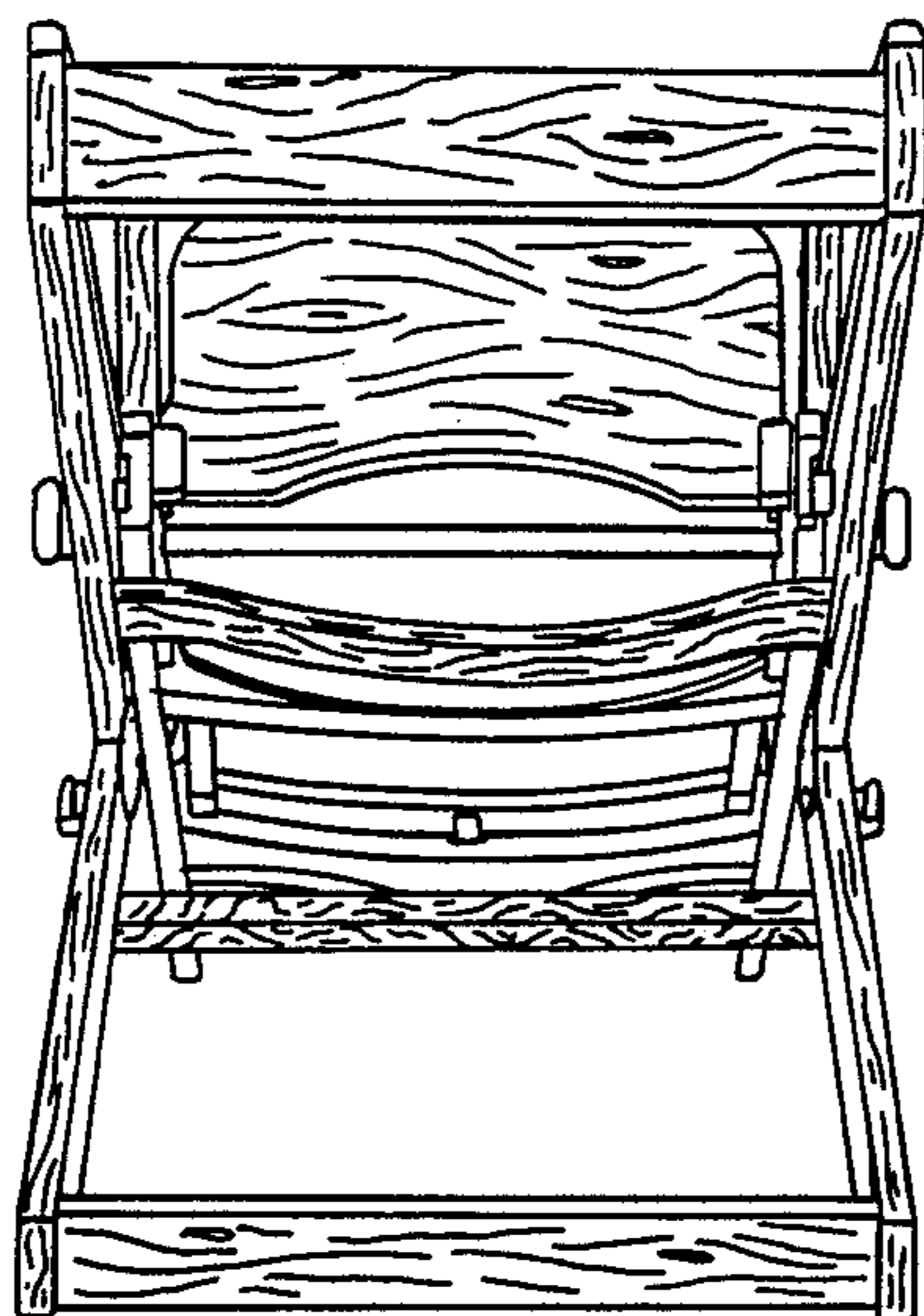

FIG. 4

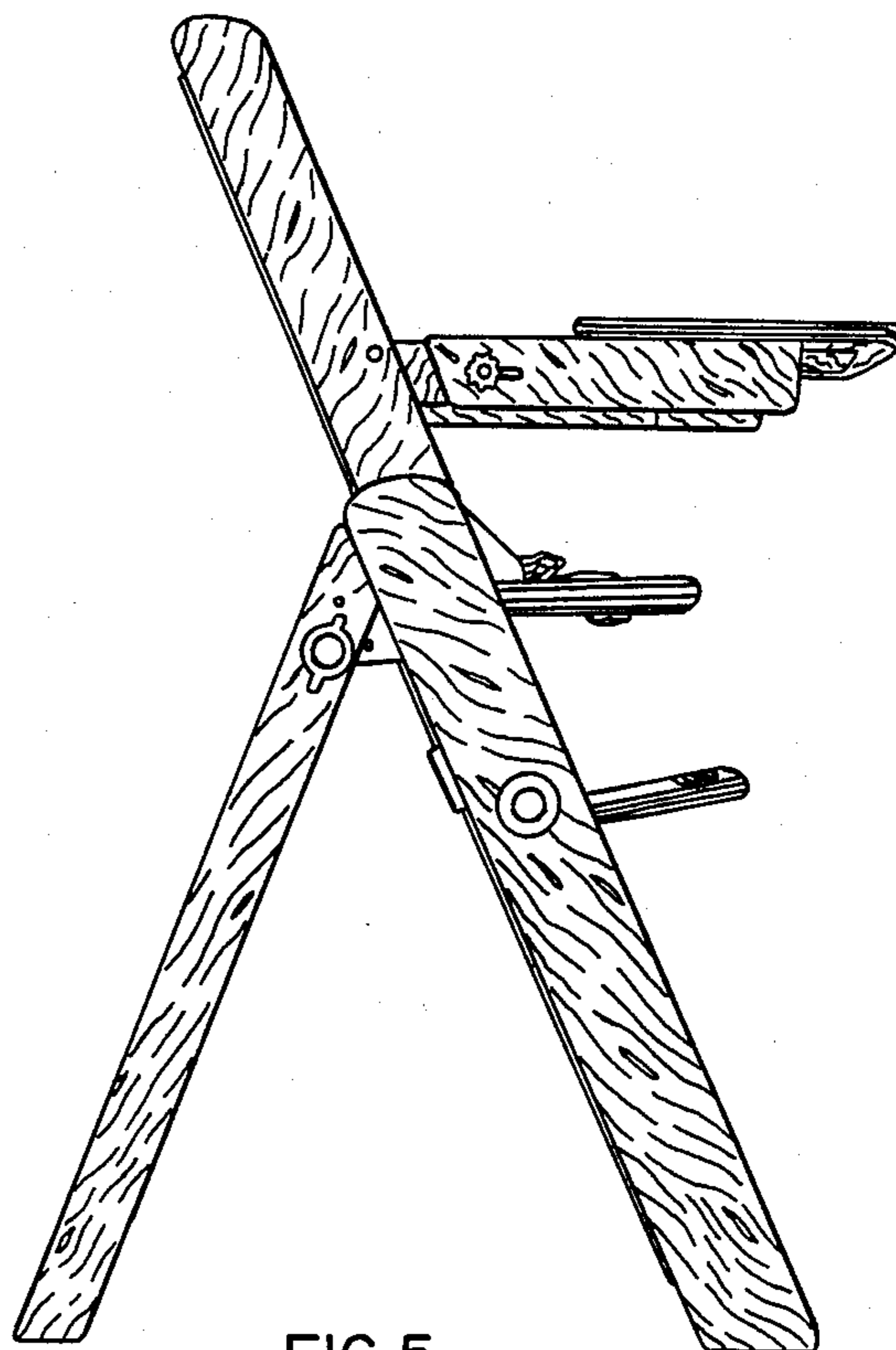

FIG. 5

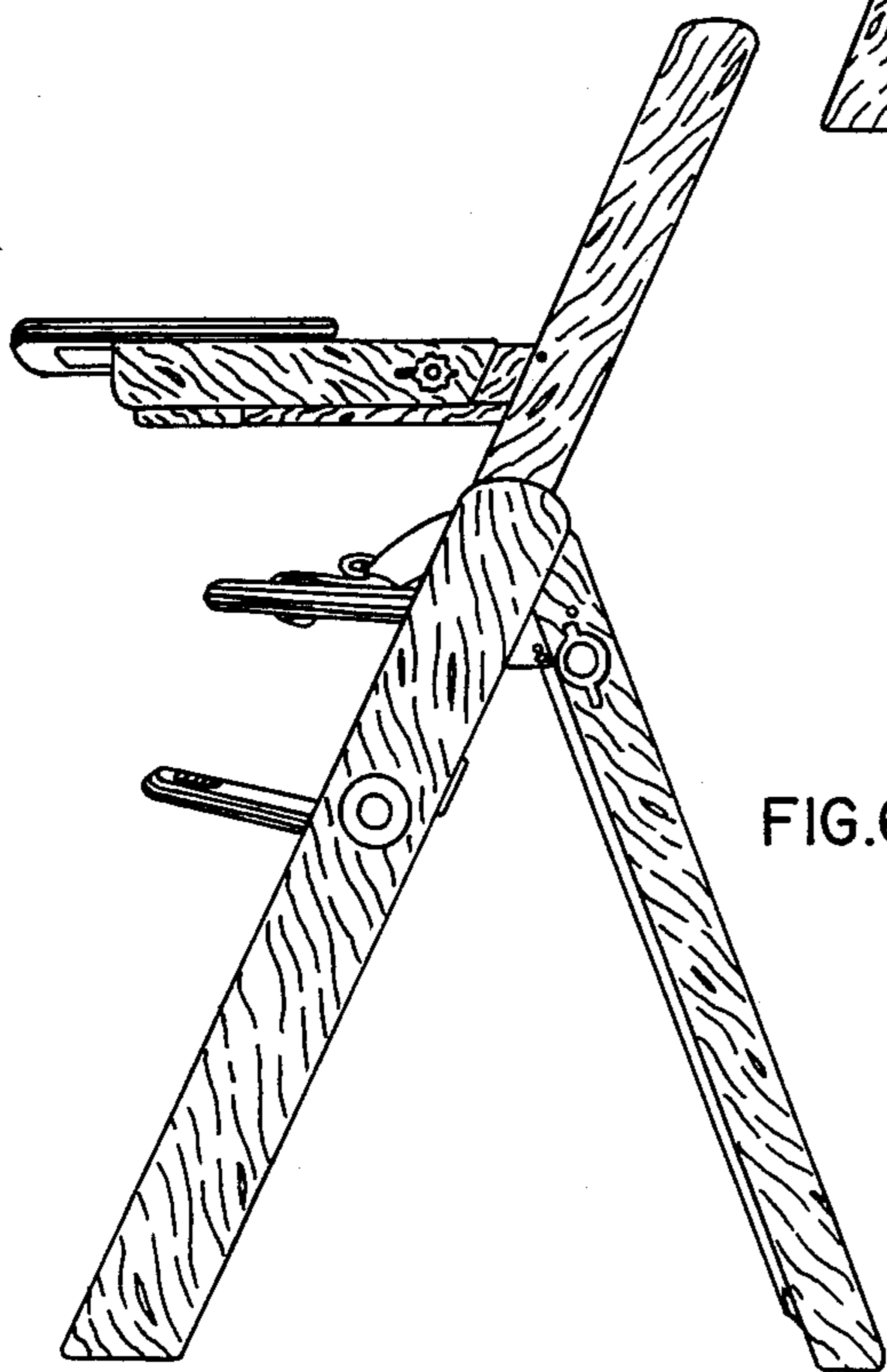

FIG. 6



FIG. 7



FIG. 8

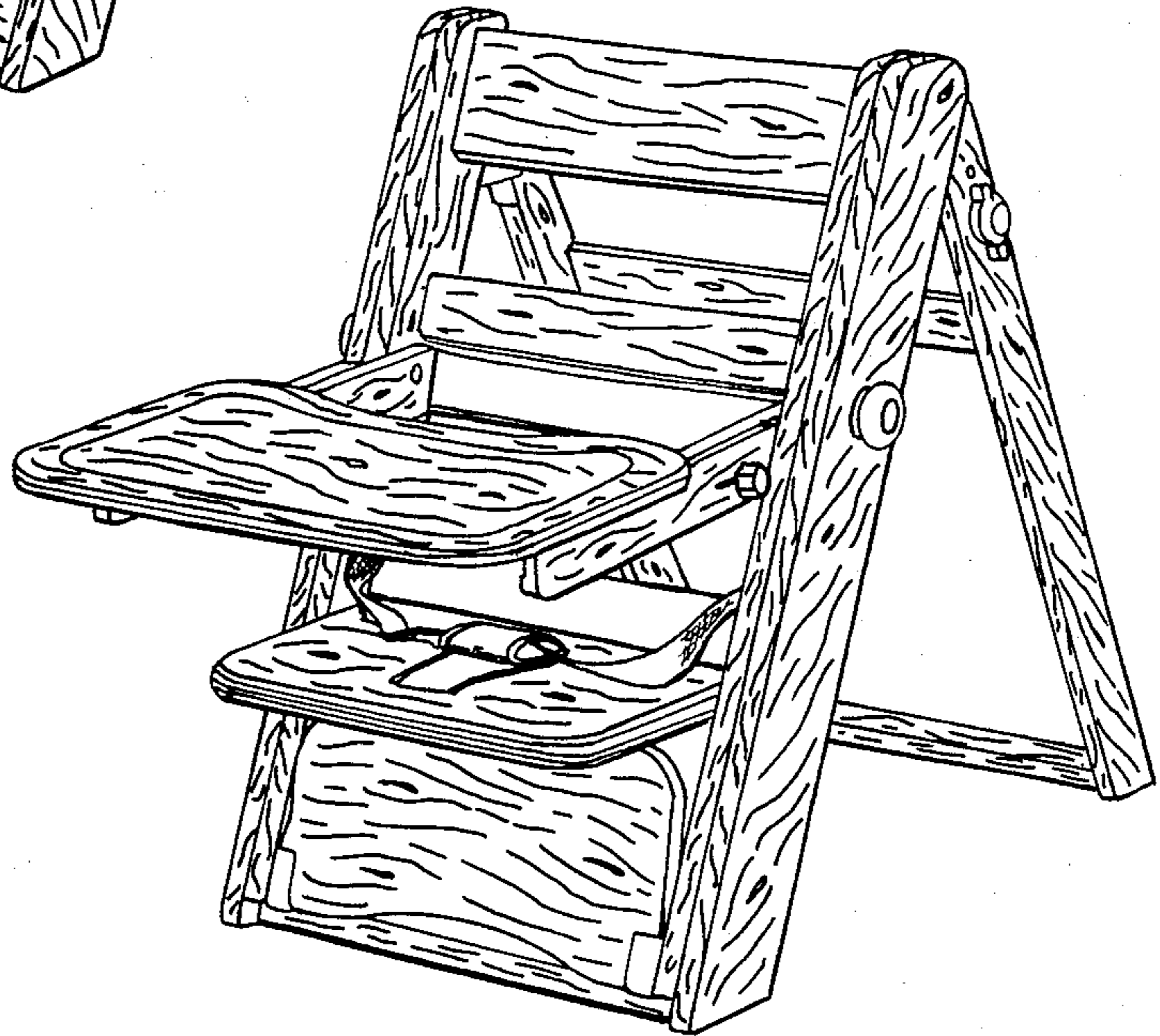

FIG. 9