

[54] **WHEELCHAIR FRAME**

[75] **Inventor: Paul H. Friedrich, Camarillo, Calif.**

[73] **Assignee: Everest & Jennings, Inc., Camarillo, Calif.**

[**] **Term: 14 Years**

[21] **Appl. No.: 132,862**

[22] **Filed: Dec. 14, 1987**

[52] **U.S. Cl. D12/133; D12/131**

[58] **Field of Search D12/128, 131; 280/250.1, 304.1, 242.1; 297/DIG. 4; 180/907**

[56] **References Cited**

U.S. PATENT DOCUMENTS

D. 294,475	3/1988	Chen	D12/131
4,650,201	3/1987	Hartwell	280/250.1
4,652,005	3/1987	Hartwell	D12/131
4,682,783	7/1987	Küschall	D12/131

*Primary Examiner—Wallace R. Burke
Assistant Examiner—Kay H. Chin
Attorney, Agent, or Firm—Kelly, Bauersfeld & Lowry*

[57] **CLAIM**

The ornamental design for a wheelchair frame, as shown and described.

DESCRIPTION

FIG. 1 is a front perspective view of a wheelchair frame showing my new design, the broken lines being for illustrative purposes only and forming no part of the claimed design;

FIG. 2 is a left side elevational view thereof, the right side elevational view being a mirror image of that shown;

FIG. 3 is a front elevation view thereof;

FIG. 4 is a rear elevation view thereof;

FIG. 5 is a top plan view thereof; and

FIG. 6 is a bottom plan view thereof.

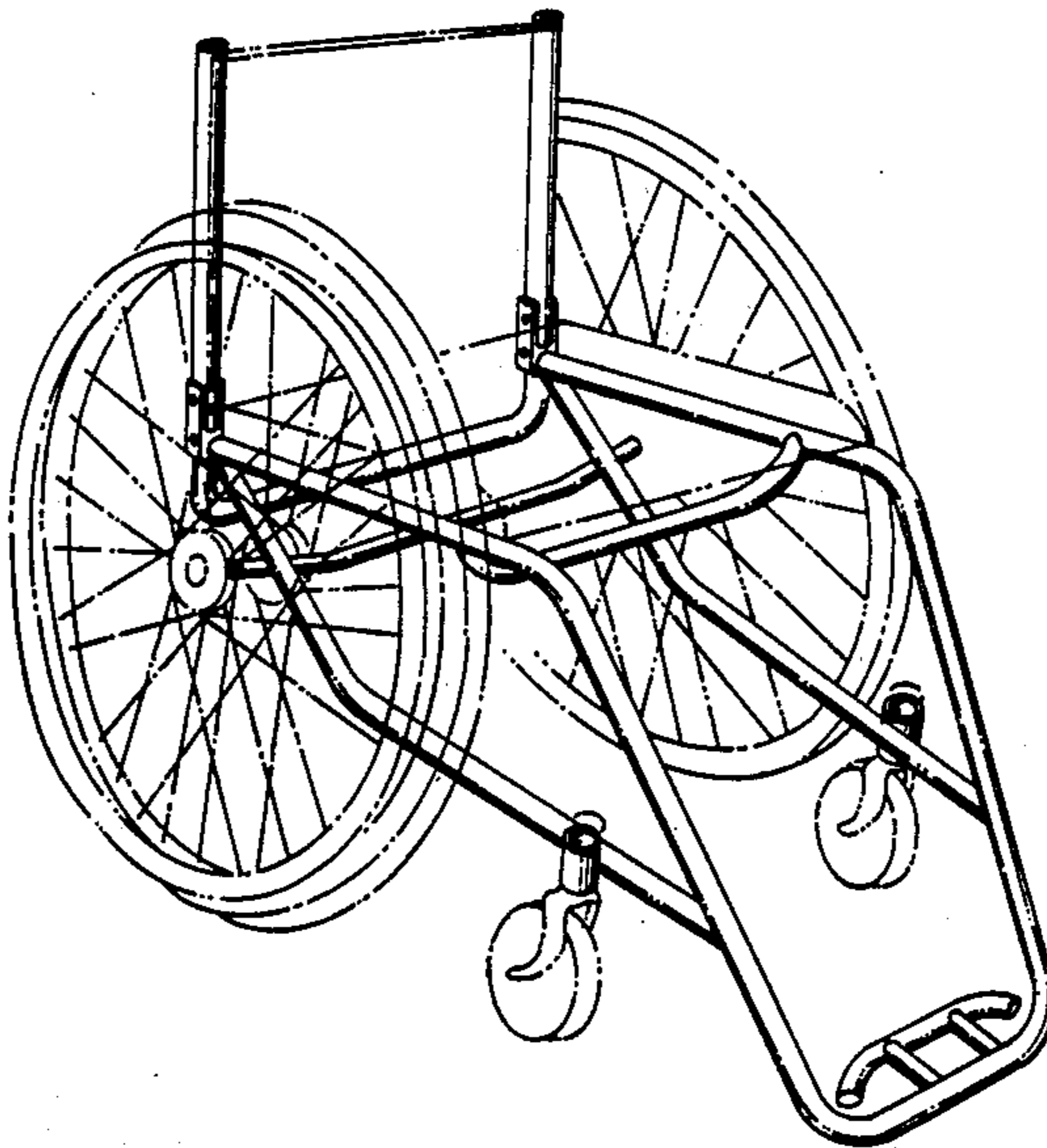

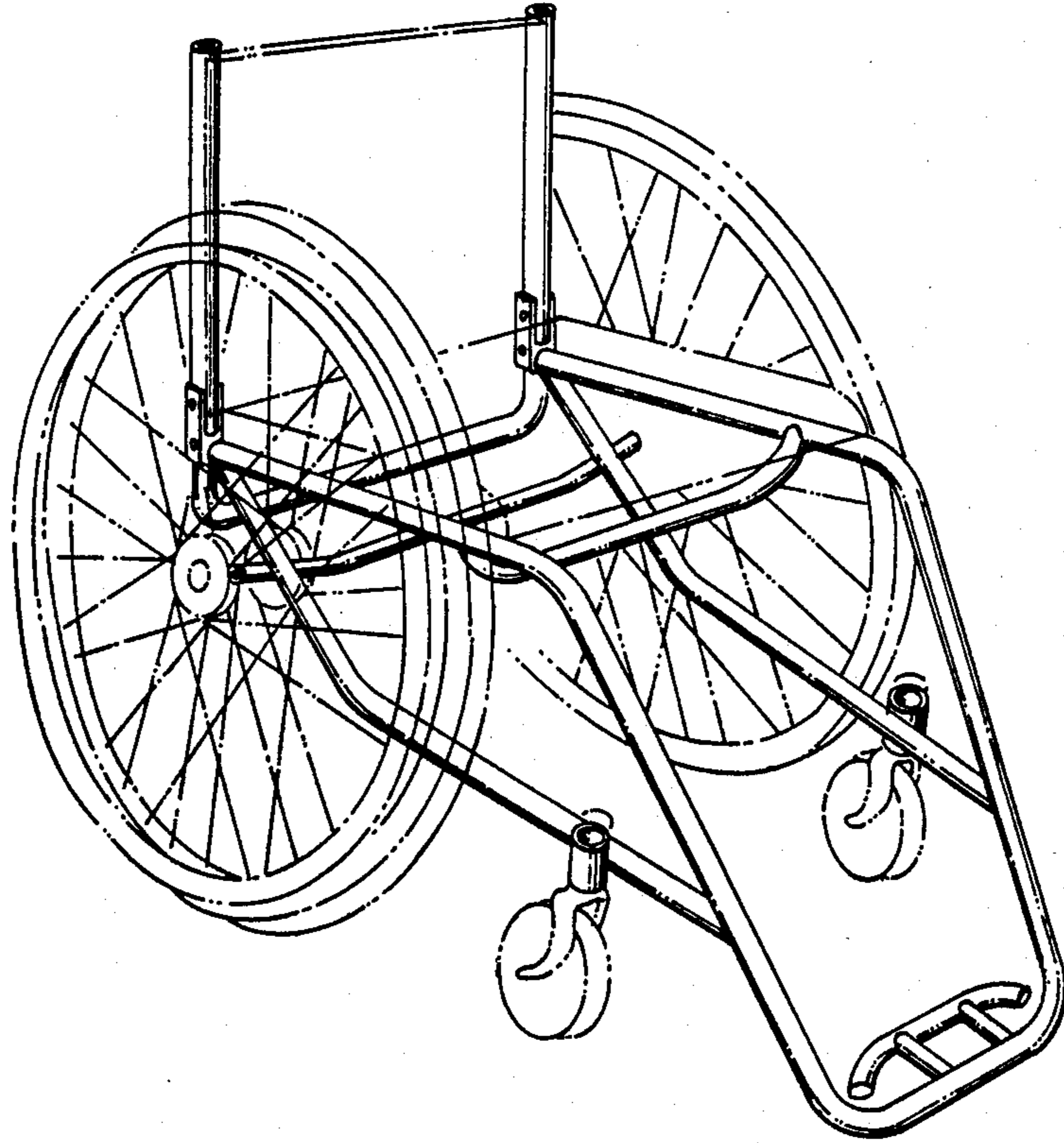

FIG. 1

FIG. 2

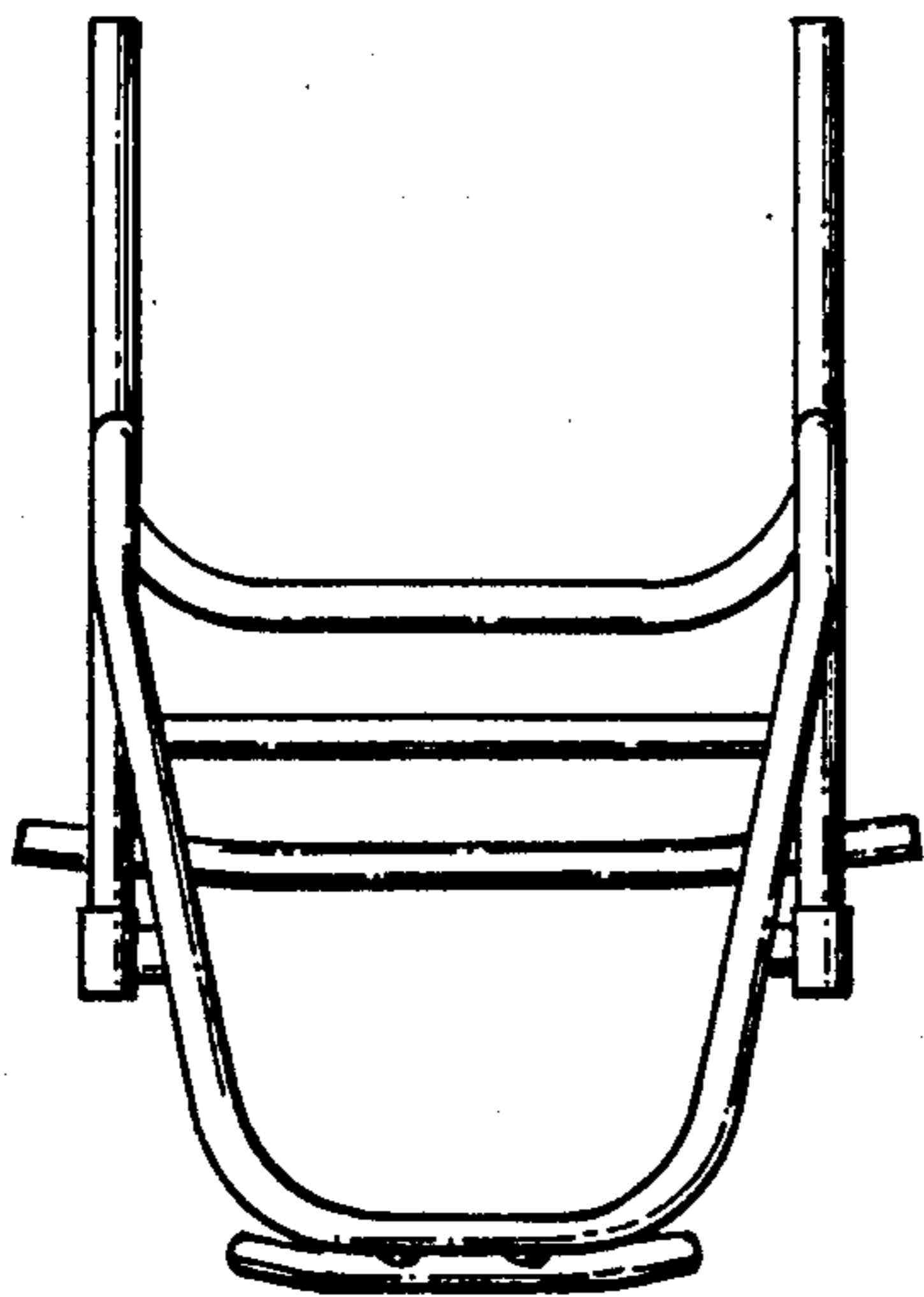
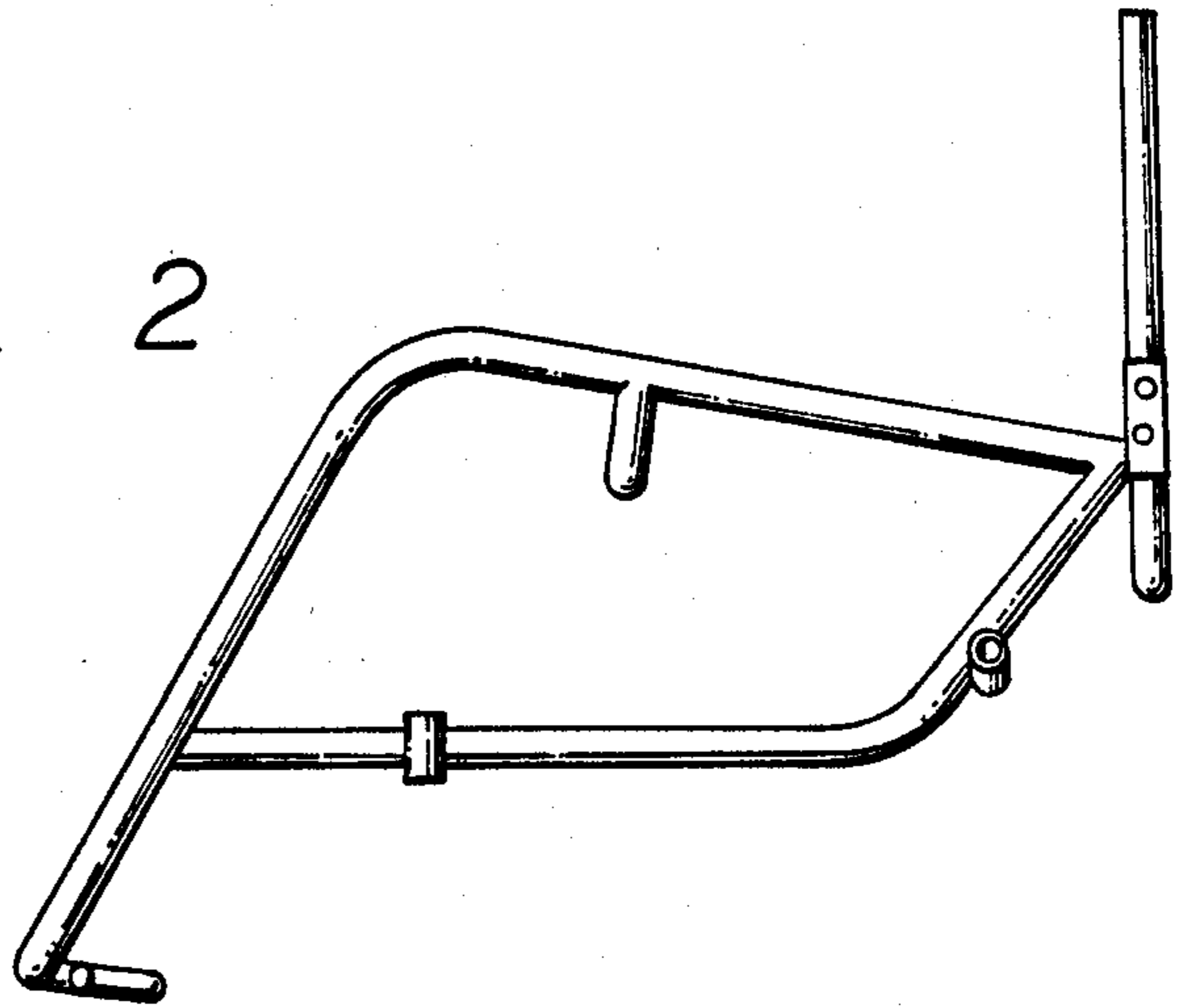

FIG. 3

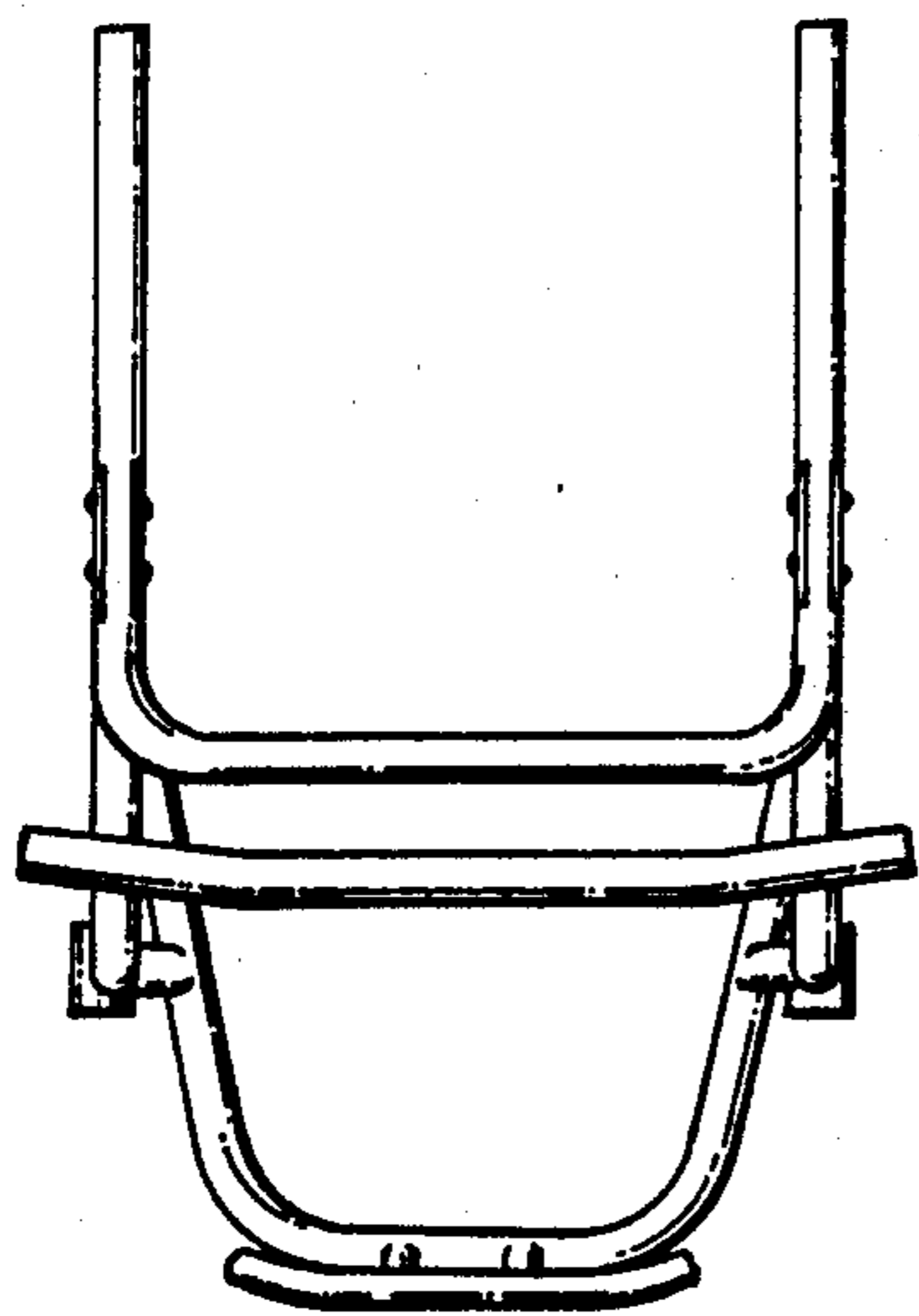

FIG. 4

FIG. 5

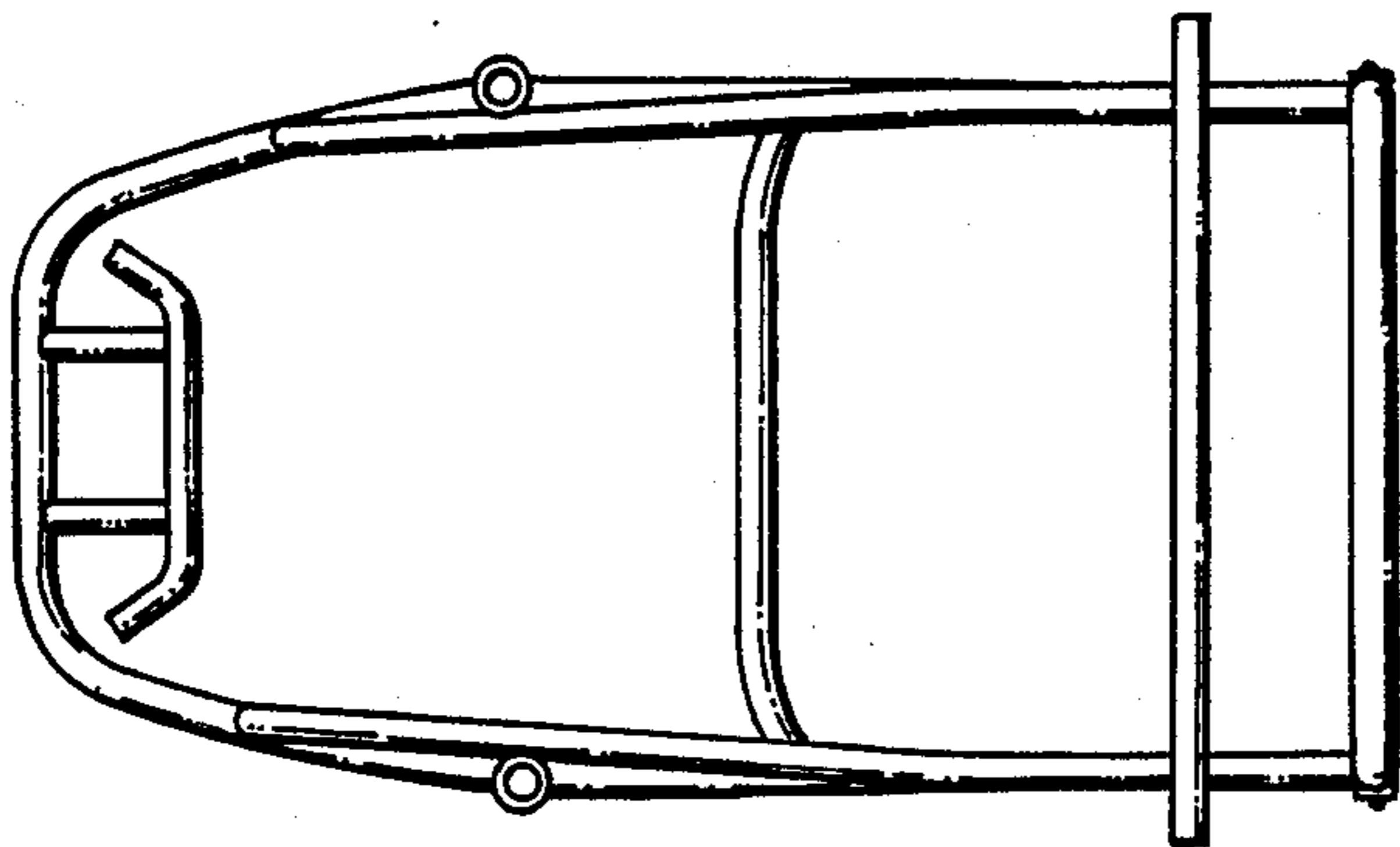
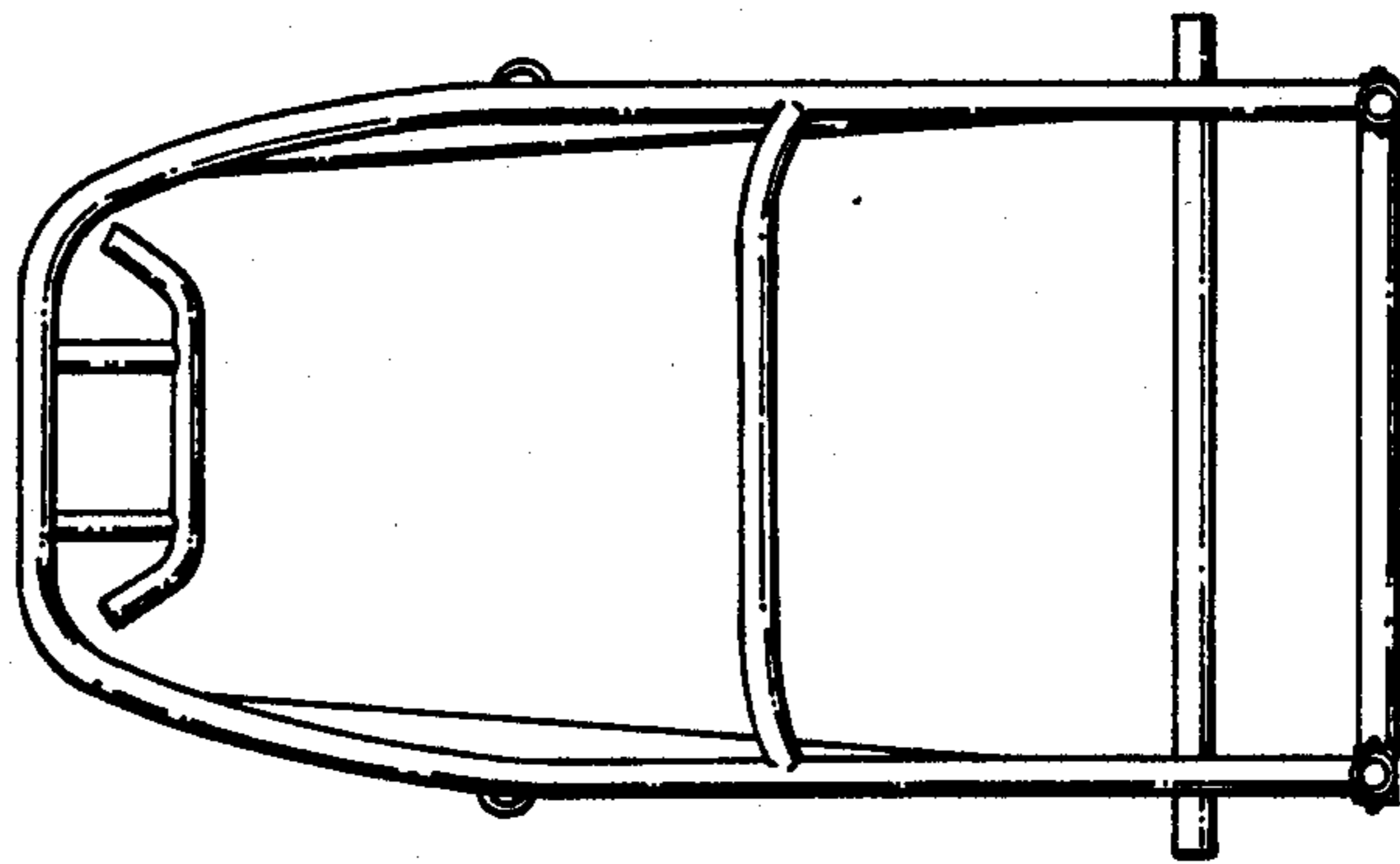

FIG. 6