

[54] TETHERED DISPENSING CLOSURE

[75] Inventor: James M. Beck, Carol Stream, Ill.

[73] Assignee: Creative Packaging Corp., Wheeling, Ill.

[**] Term: 14 Years

[21] Appl. No.: 169,362

[22] Filed: Mar. 17, 1988

[52] U.S. Cl. D9/446; D9/447

[58] Field of Search D9/434, 440, 446, 447; 222/499, 502, 519, 531, 532, 533, 537, 543, 552, 556, 562, 566; 215/296, 306, 316, 329, 355

[56] References Cited

U.S. PATENT DOCUMENTS

D. 174,205	5/1955	Ward	D9/446
D. 193,121	6/1962	Wickman	D9/447
D. 197,926	4/1964	Stull	D9/446
D. 265,060	6/1982	Blank	D9/446
D. 278,414	4/1985	Cho	D9/446
D. 297,598	9/1988	Stull	D9/446
3,117,702	1/1964	Henchert	D9/446
3,741,447	6/1973	Miles et al.	222/498
3,779,429	12/1973	Porcelli	D9/446
4,358,032	11/1982	Libit	215/335
4,778,071	10/1988	Fillmore	222/498

Primary Examiner—B. J. Bullock

Assistant Examiner—Dominic Simone
Attorney, Agent, or Firm—Silverman, Cass & Singer, Ltd.

[57] CLAIM

The ornamental design for a tethered dispensing closure, as shown and described.

DESCRIPTION

FIG. 1 is a rear perspective of a tethered dispensing closure showing my new design;
 FIG. 2 is an enlarged top plan view thereof;
 FIG. 3 is an enlarged front elevational view thereof;
 FIG. 4 is an enlarged right side elevational view thereof, the left side being a mirror image;
 FIG. 5 is an enlarged rear elevational view thereof;
 FIG. 6 is an enlarged bottom plan view thereof;
 FIG. 7 is a rear perspective view thereof, the closure in a position for use;
 FIG. 8 is a rear perspective view of a second embodiment of FIG. 1;
 FIG. 9 is an enlarged top plan view of FIG. 8;
 FIG. 10 is an enlarged front elevational view of FIG. 8;
 FIG. 11 is an enlarged right side elevational view of FIG. 8, the left side being a mirror image;
 FIG. 12 is an enlarged rear elevational view of FIG. 8;
 FIG. 13 is an enlarged bottom plan view of FIG. 8;
 FIG. 14 is a rear perspective view of FIG. 8, the closure in a position for use.

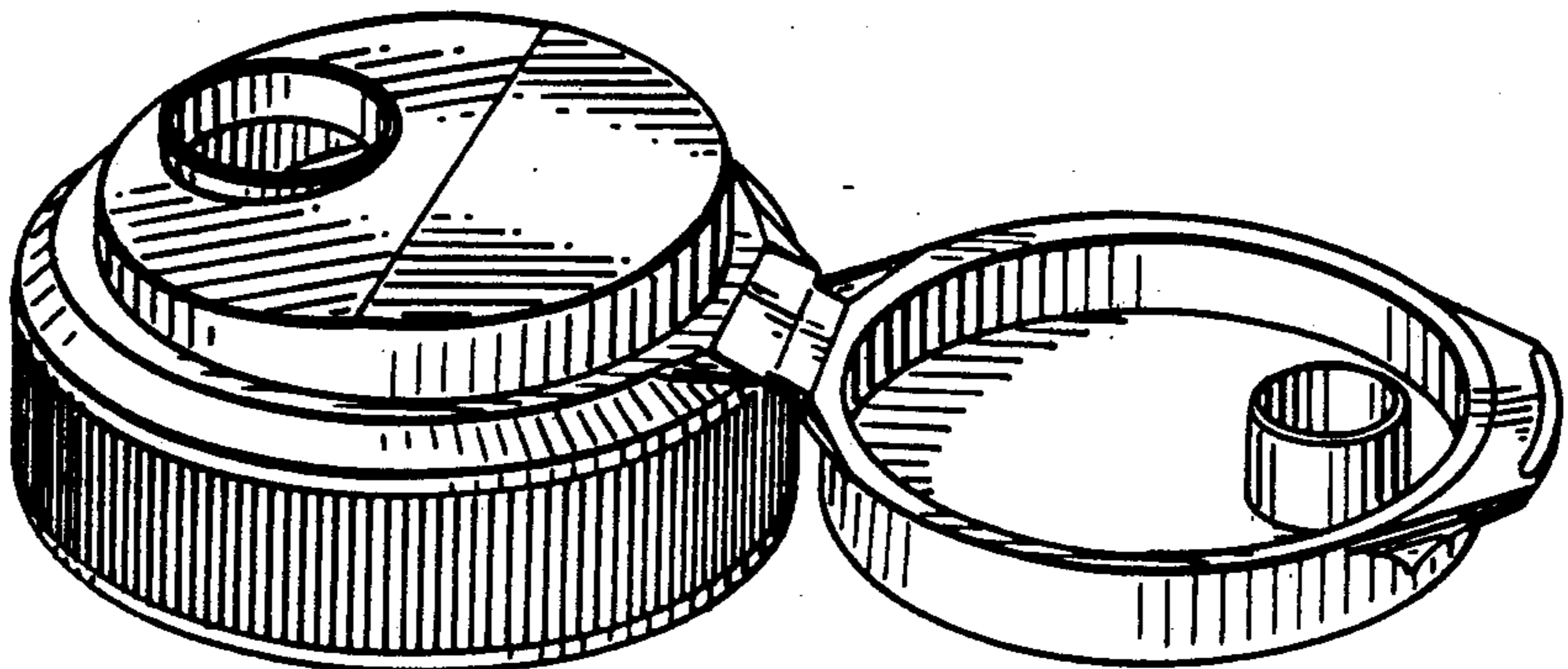
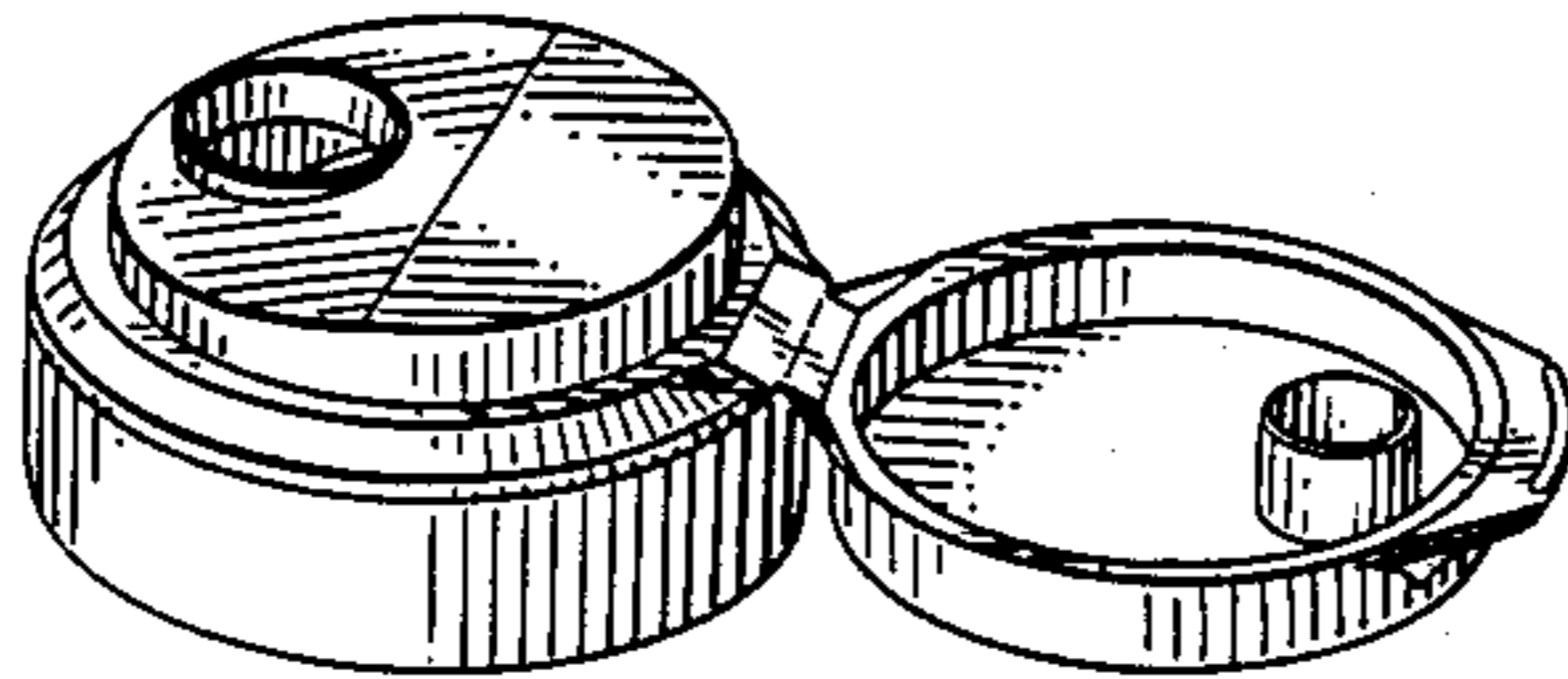

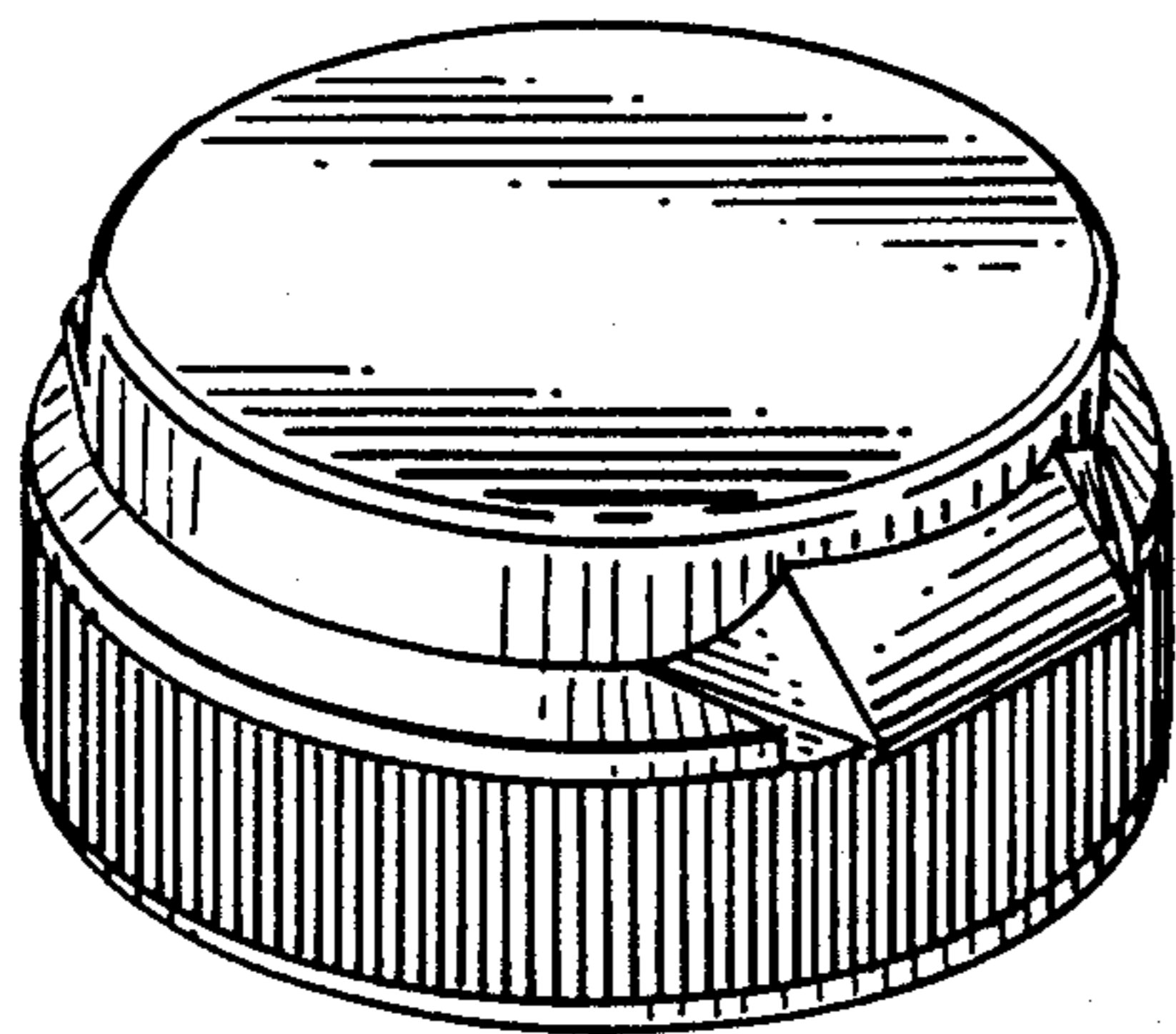

FIG. 1

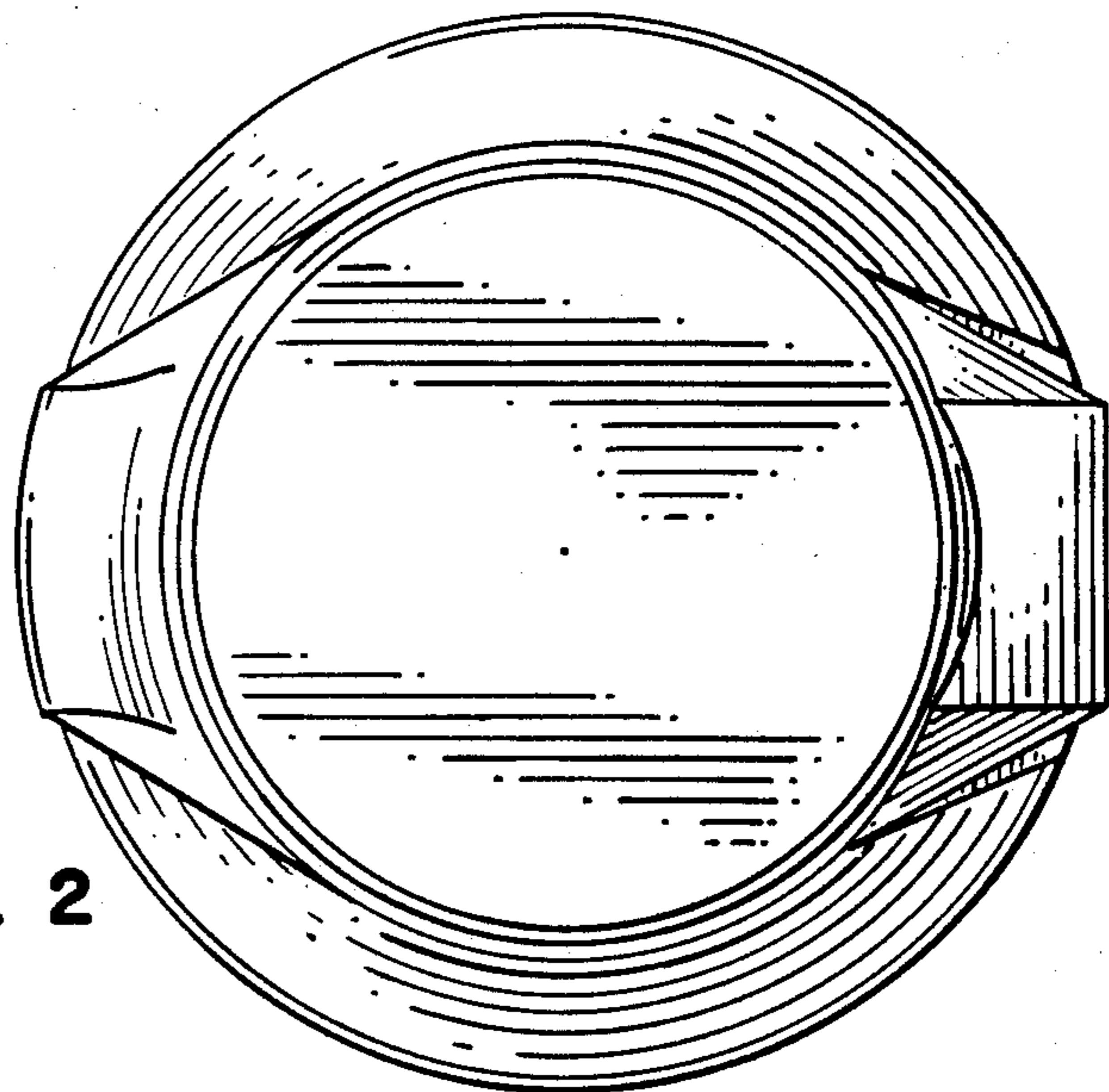

FIG. 2

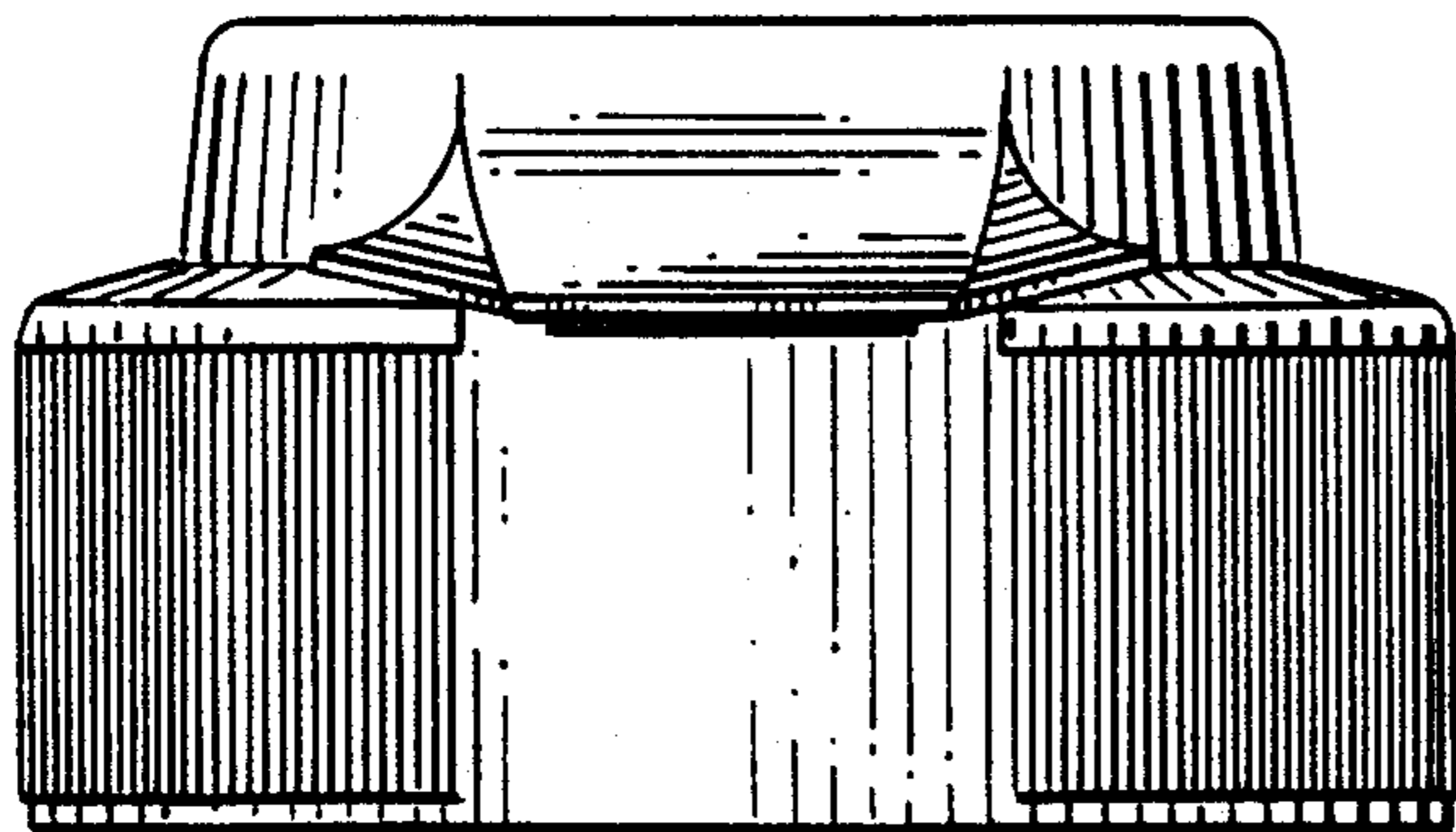

FIG. 3

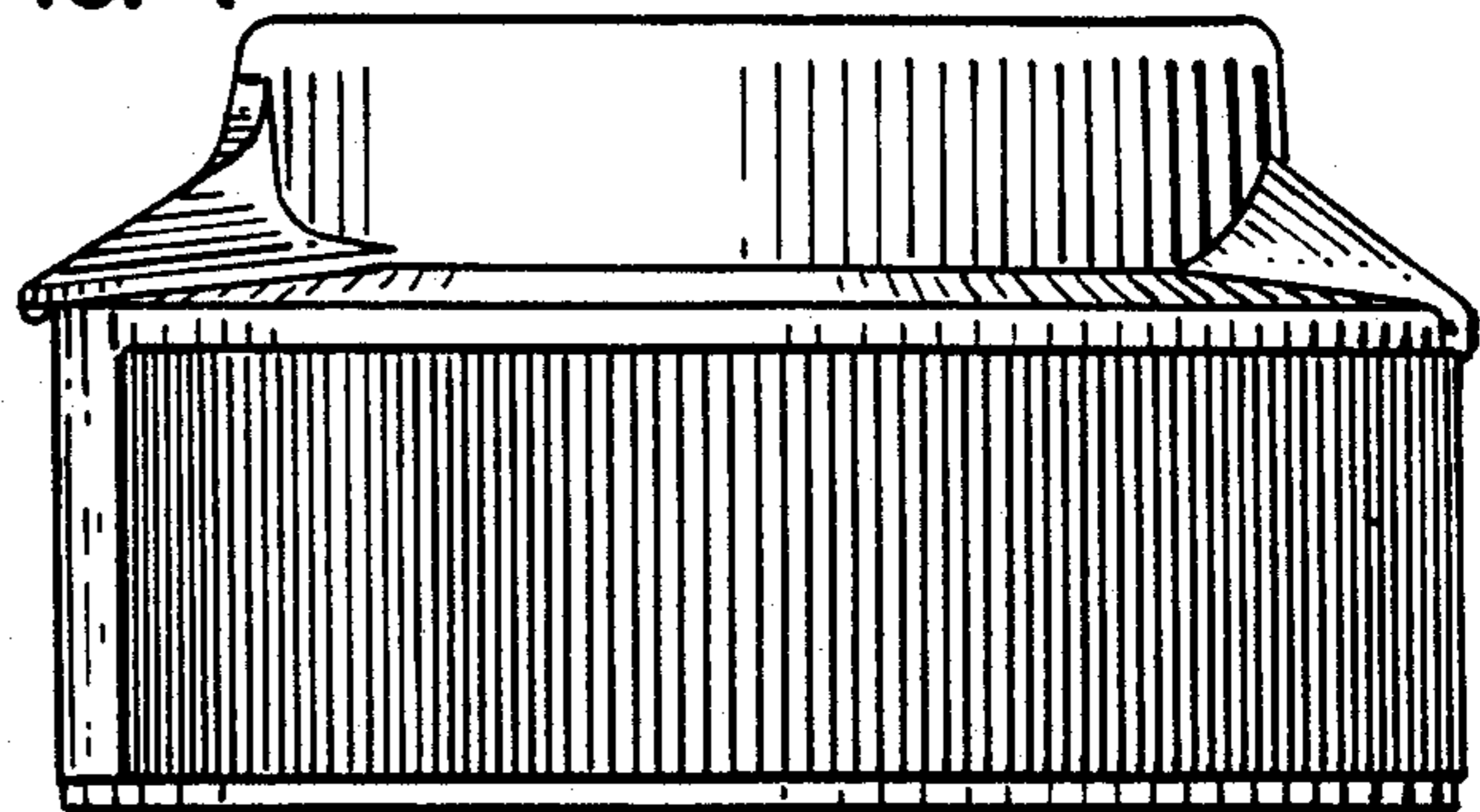

FIG. 4

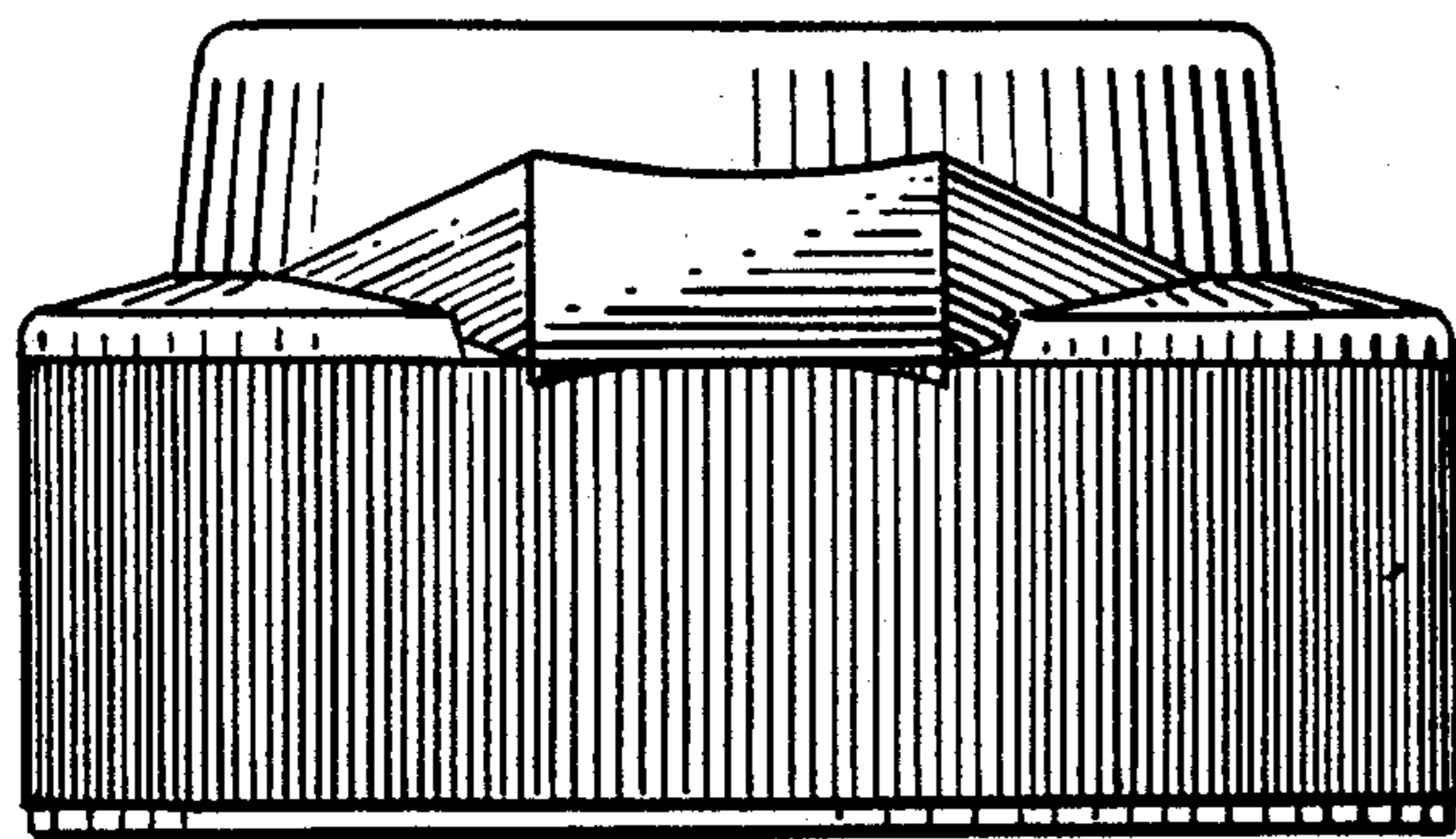

FIG. 5

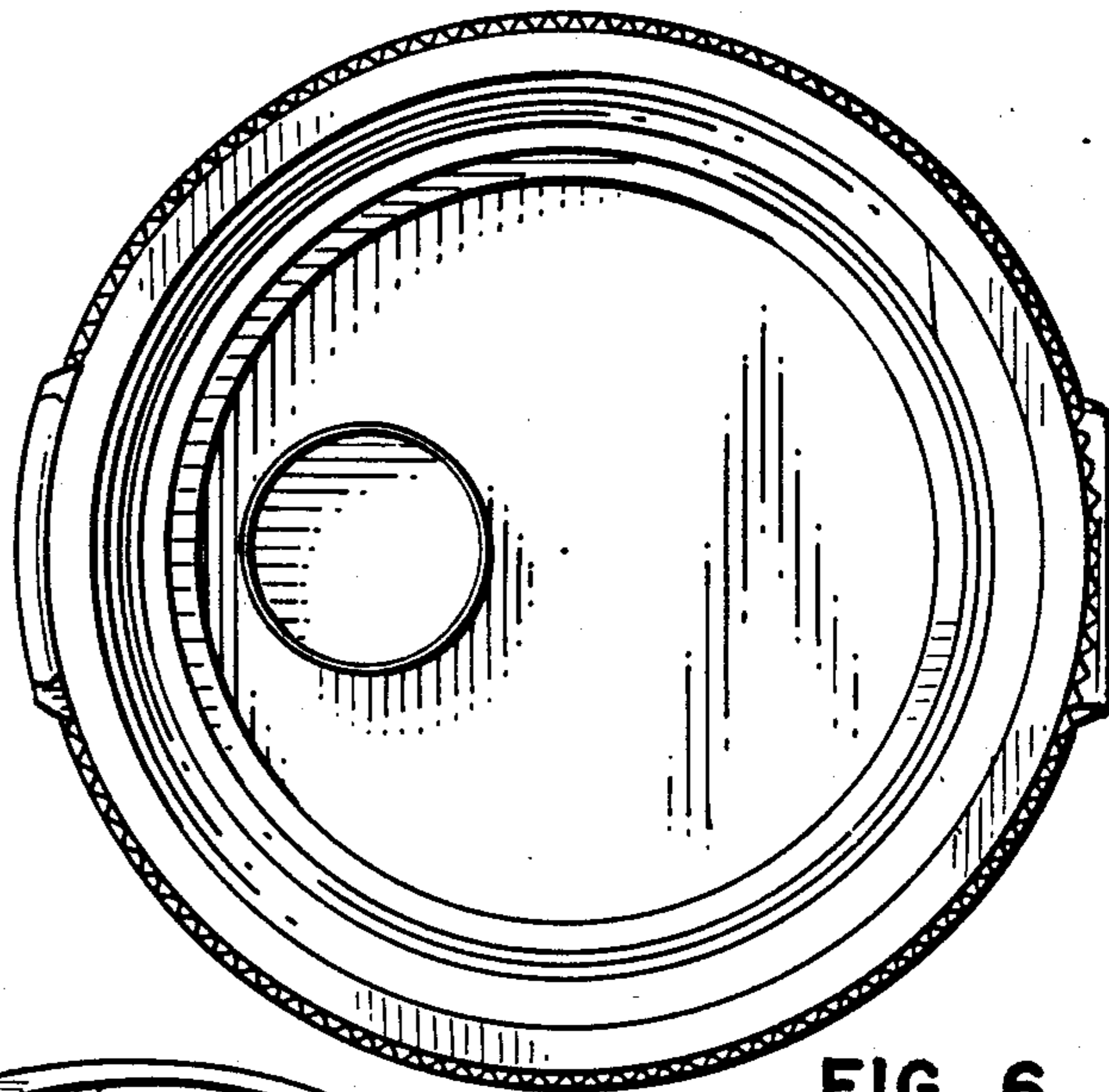

FIG. 6

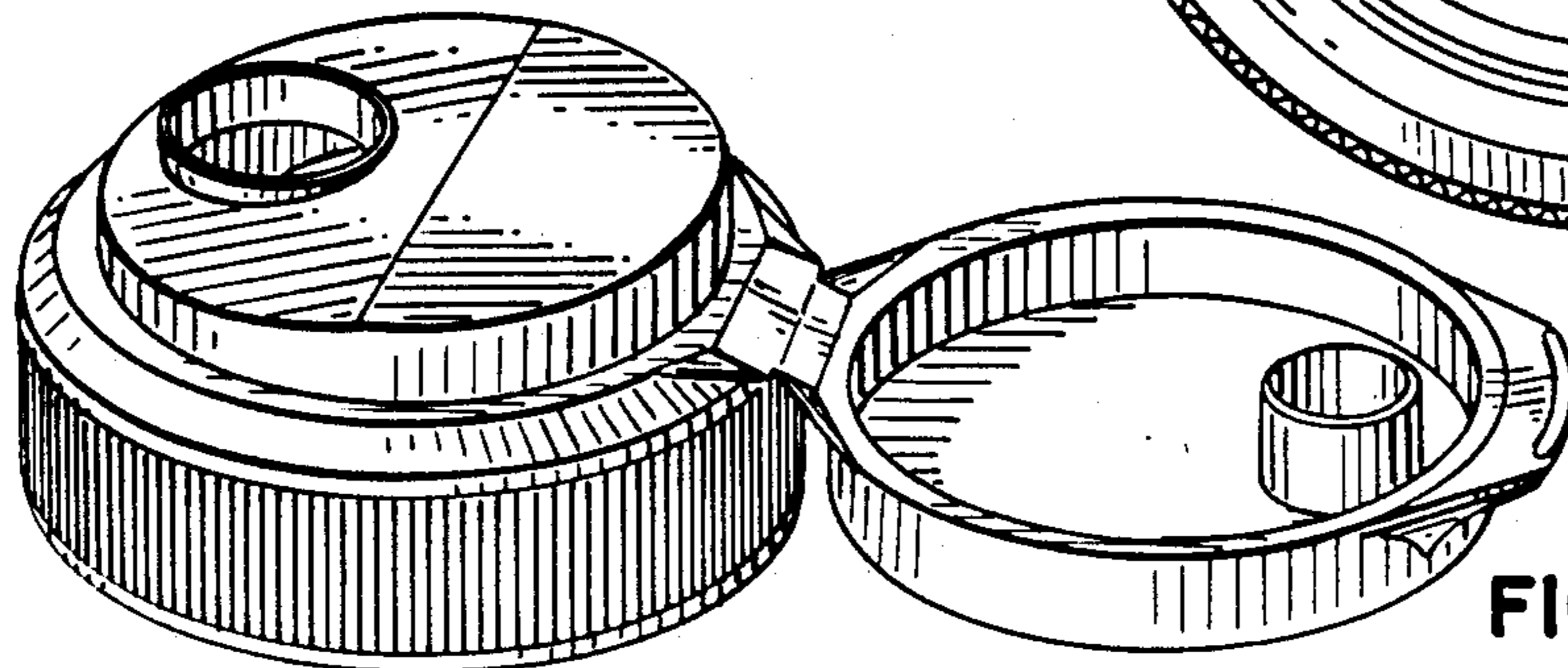

FIG. 7

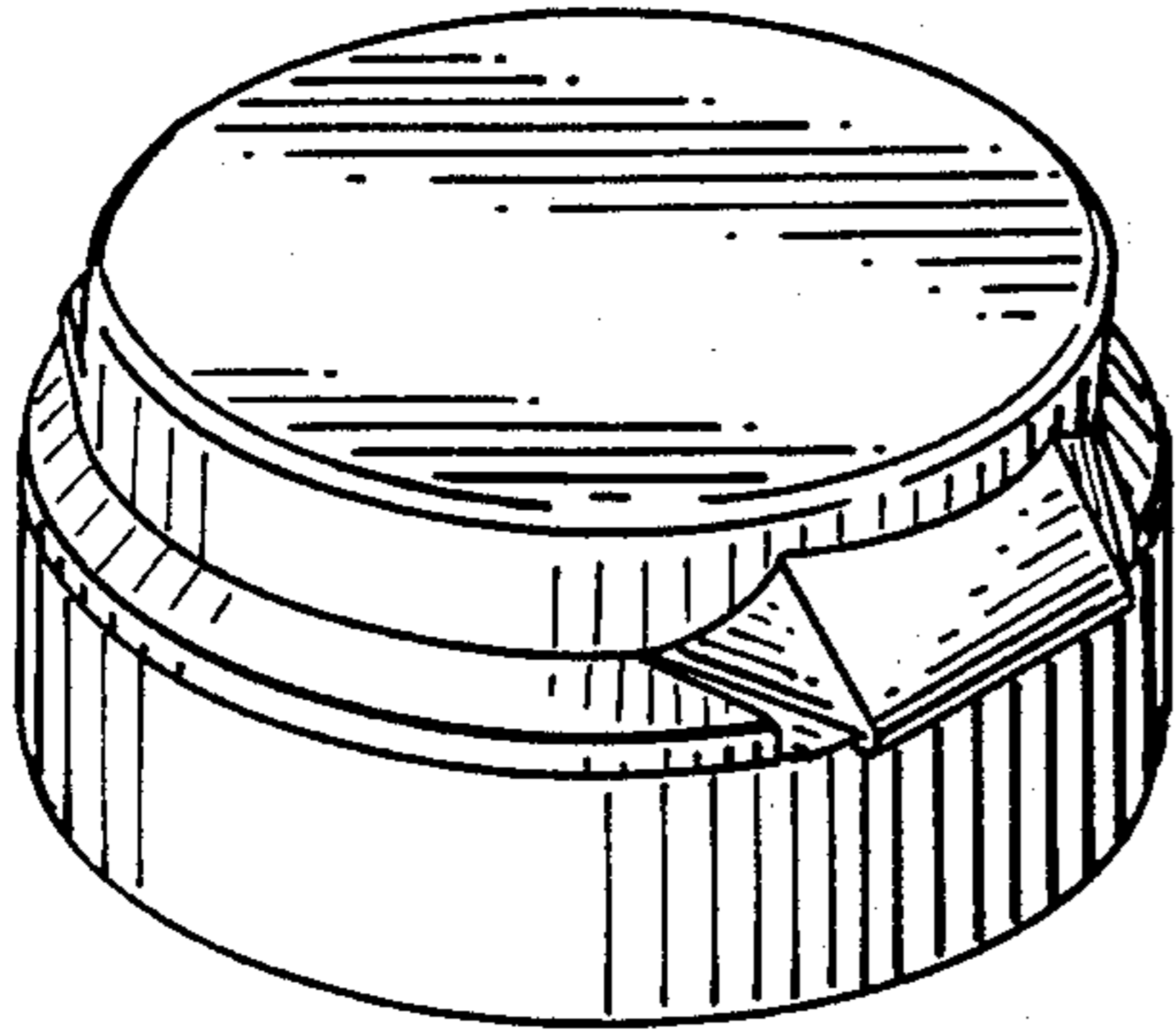

FIG. 8

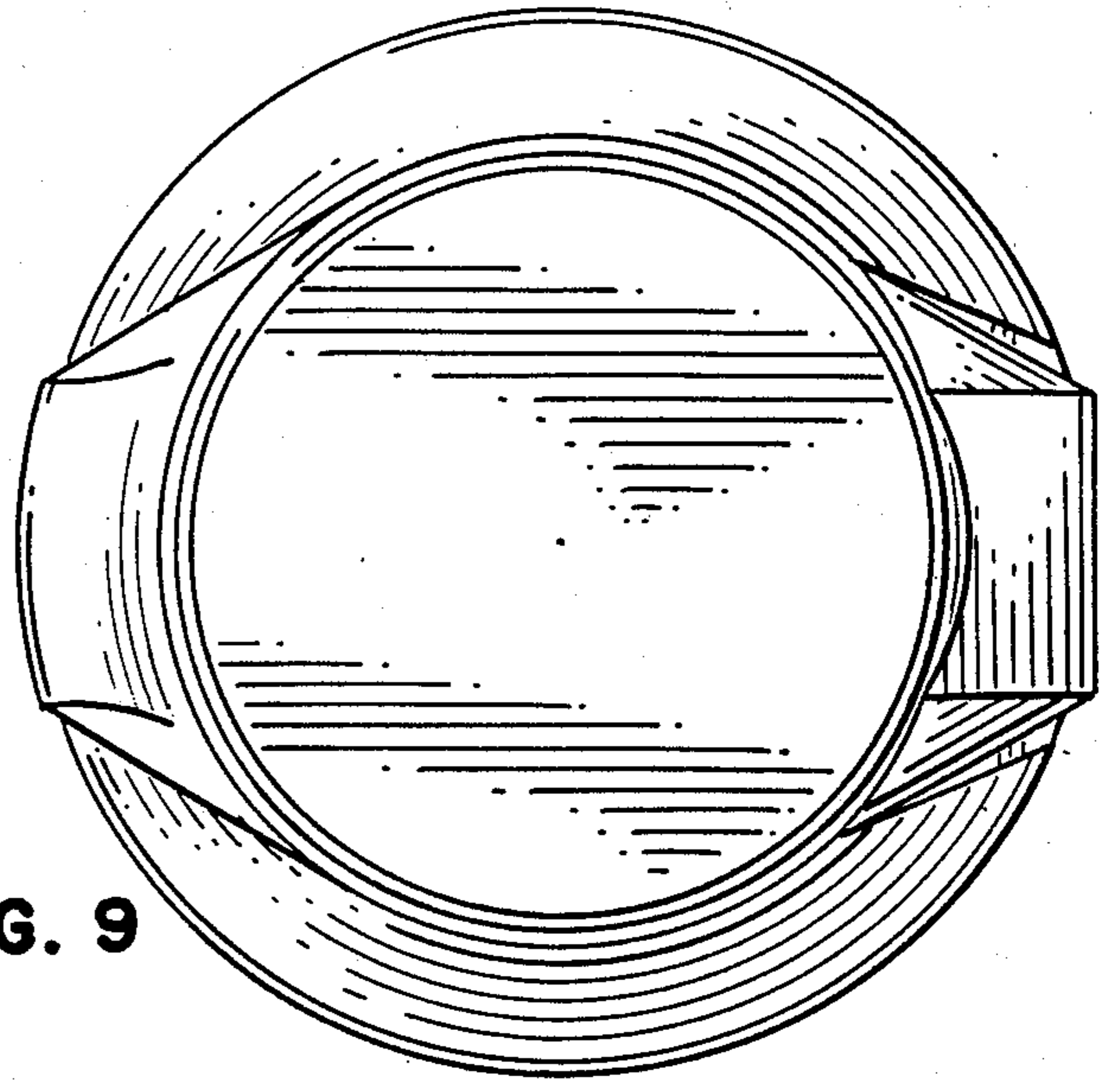

FIG. 9

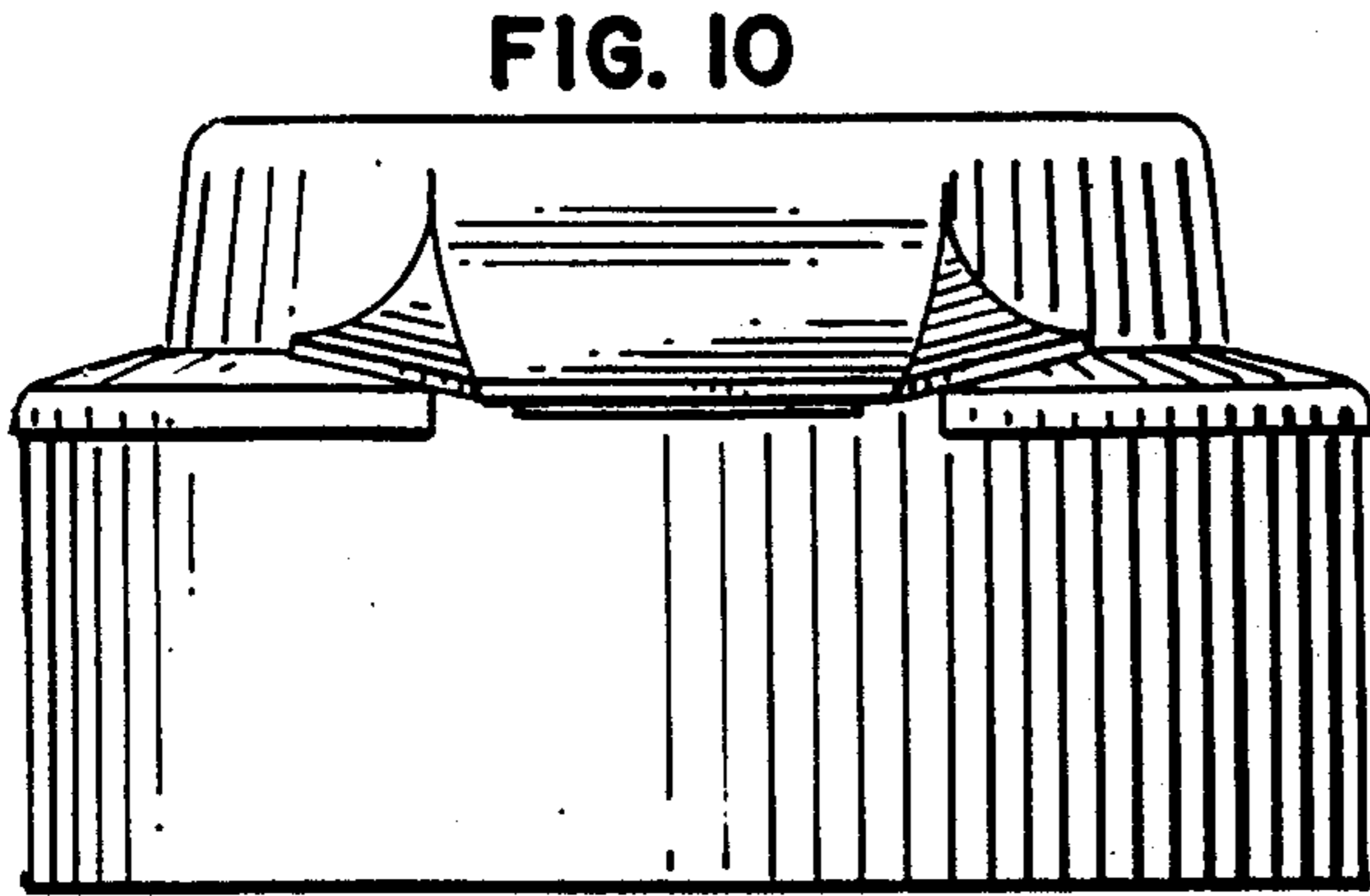

FIG. 10

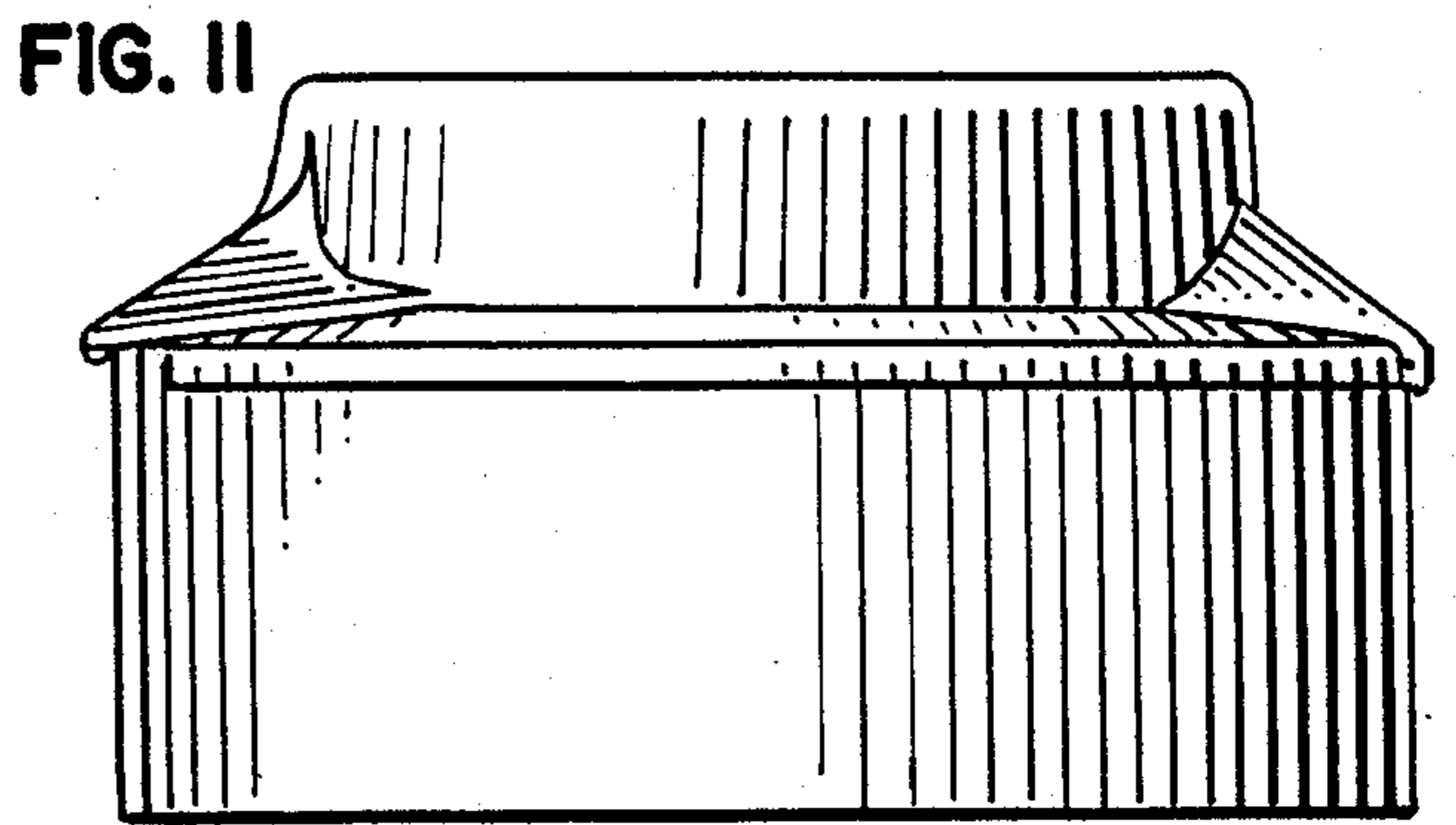

FIG. 11

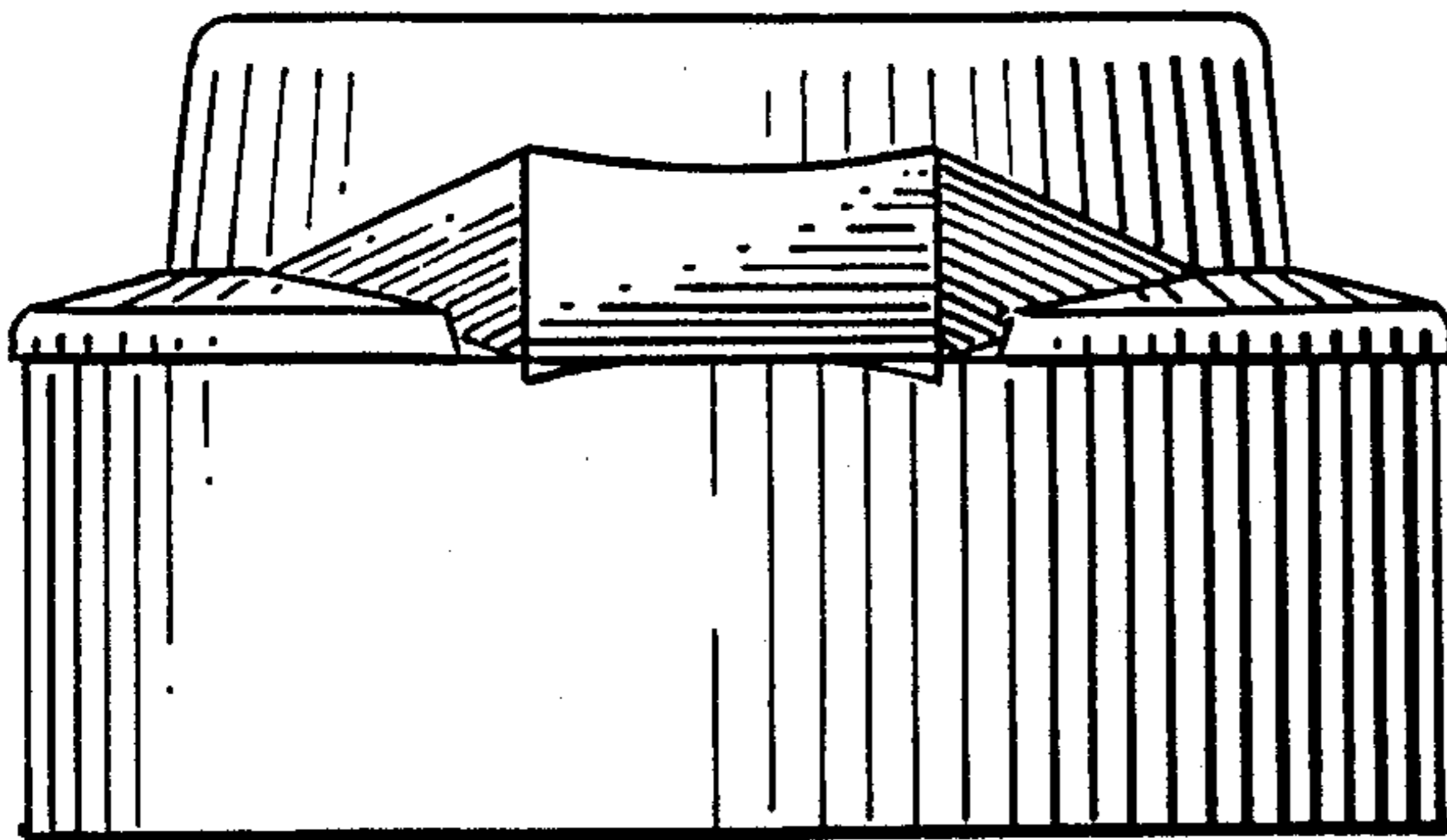

FIG. 12

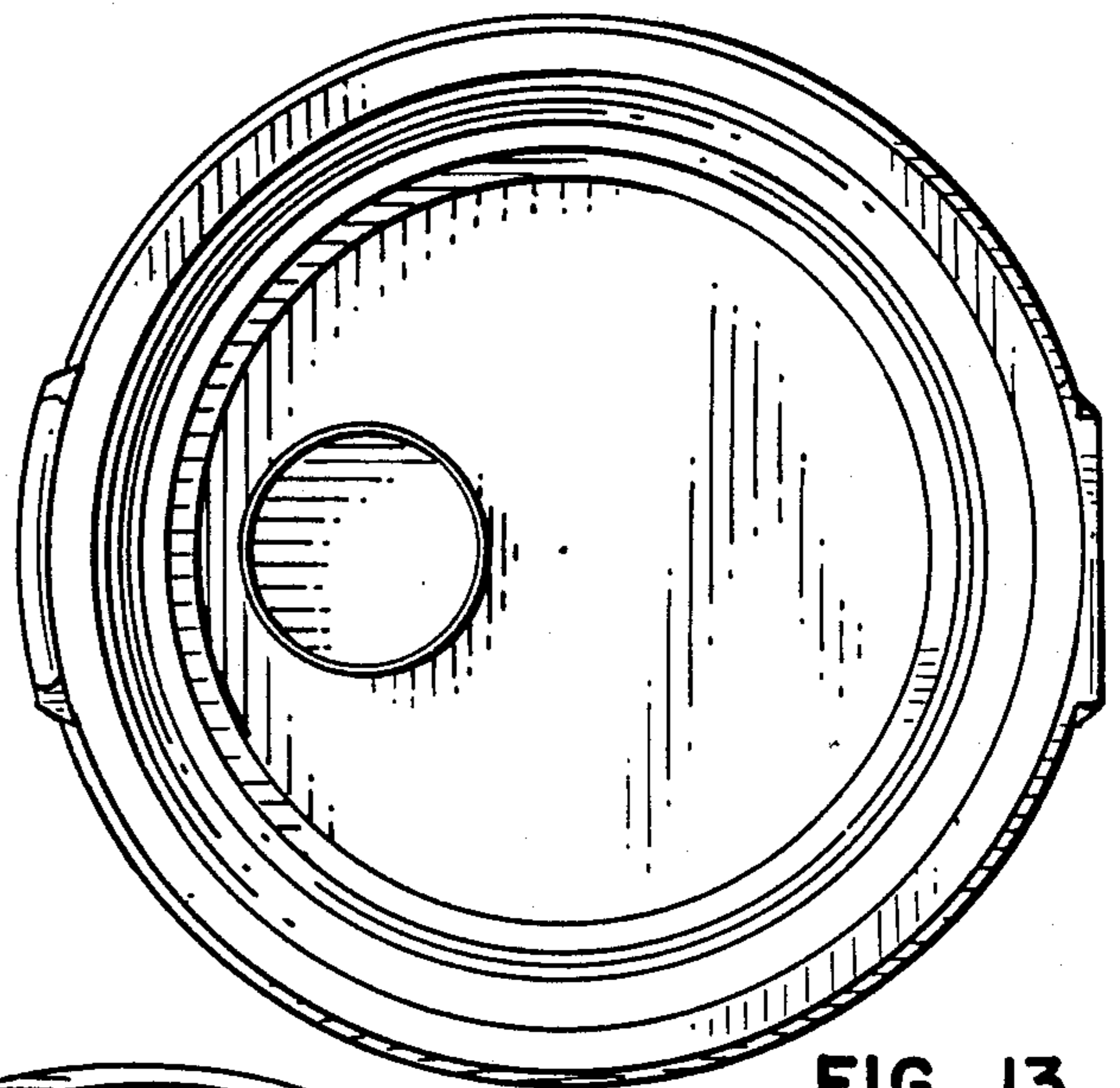

FIG. 13

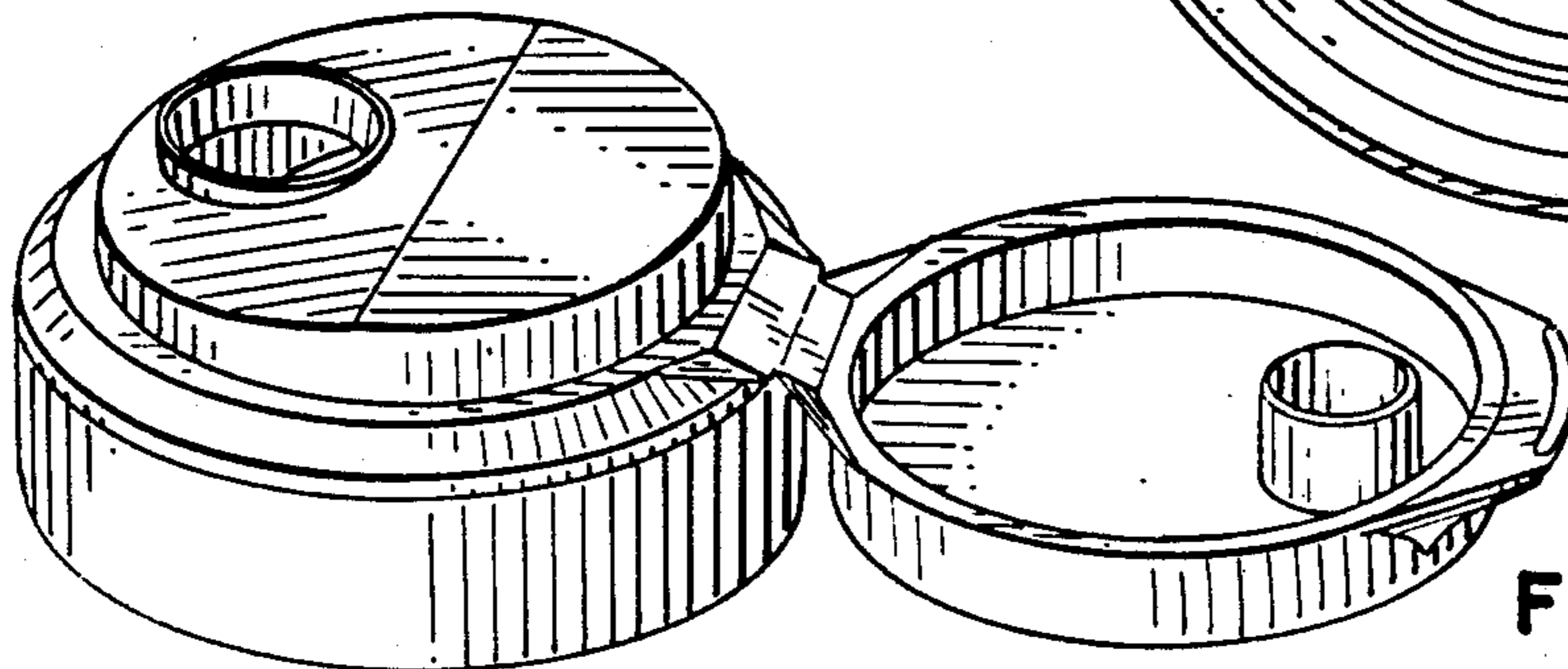

FIG. 14