

[54] DISPOSABLE CAMERA

[75] Inventor: Takuya Arai, Tokyo, Japan

[73] Assignee: Fuji Photo Film Co., Ltd., Kanagawa, Japan

[**] Term: 14 Years

[21] Appl. No.: 934,451

[22] Filed: Nov. 24, 1986

[30] Foreign Application Priority Data

May 23, 1986 [JP] Japan 61-19614

[52] U.S. Cl. D9/305; D9/307; D16/213

[58] Field of Search D9/305, 306, 307, 415, D9/414, 432; 220/DIG. 13; 206/461, 471, 463; D16/200, 213, 208; 354/75, 129, 152, 171, 174, 288

[56] References Cited

U.S. PATENT DOCUMENTS

D. 37,760	12/1905	Putnam	D9/414
D. 69,799	3/1926	Harris	D9/432
D. 244,055	4/1977	Shimano et al.	D16/213
D. 248,306	6/1978	Pinchuk	D16/213
D. 284,168	6/1986	Curry	D9/415
3,538,822	11/1970	Gilmer	354/75
4,226,517	10/1980	Skarmon	354/171

4,751,536	6/1988	Ohmura et al.	354/75
4,758,852	7/1988	Maejima	354/75

OTHER PUBLICATIONS

Evans Catalog 1984-1985; p. 343; upper right Kodak Film Carton.

Best Products Catalog; Mar. 1983; p. 135, FIG. A Kodak Pocket Instamatic.

Primary Examiner—Melvin B. Feifer

Assistant Examiner—Dominic Simone

Attorney, Agent, or Firm—Young & Thompson

[57] CLAIM

The ornamental design for a disposable camera, as shown and described.

DESCRIPTION

FIG. 1 is a perspective view of a disposable camera showing my new design;

FIG. 2 is a front view thereof;

FIG. 3 is a rear view thereof;

FIG. 4 is a left side view thereof;

FIG. 5 is a right side view thereof;

FIG. 6 is a top plan view thereof;

FIG. 7 is a bottom plan view thereof; and

FIG. 8 is a perspective view similar to FIG. 1 but showing the internal disposal camera.

The stippling in the drawings indicates a darker color than the areas that are not stippled.

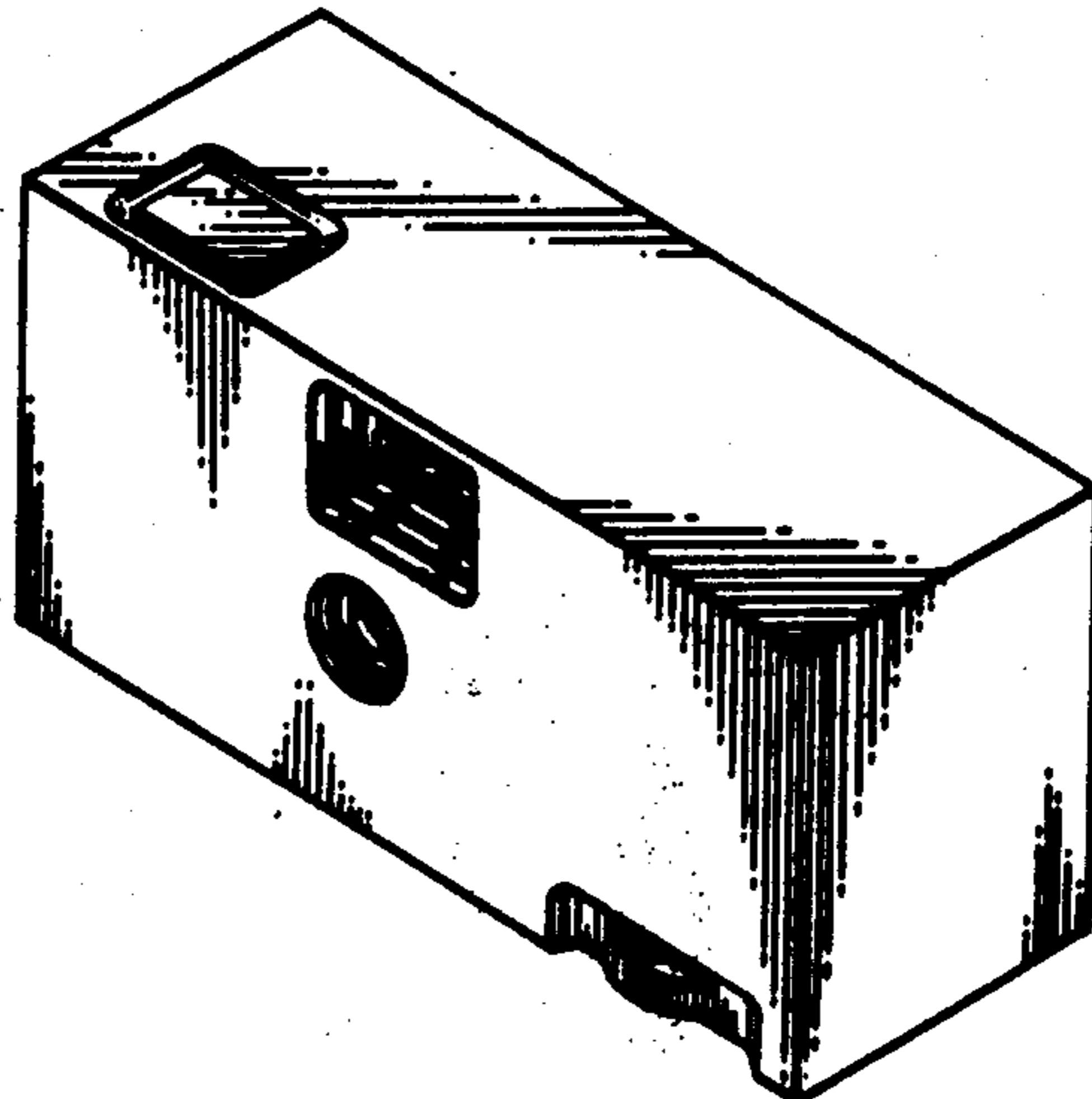
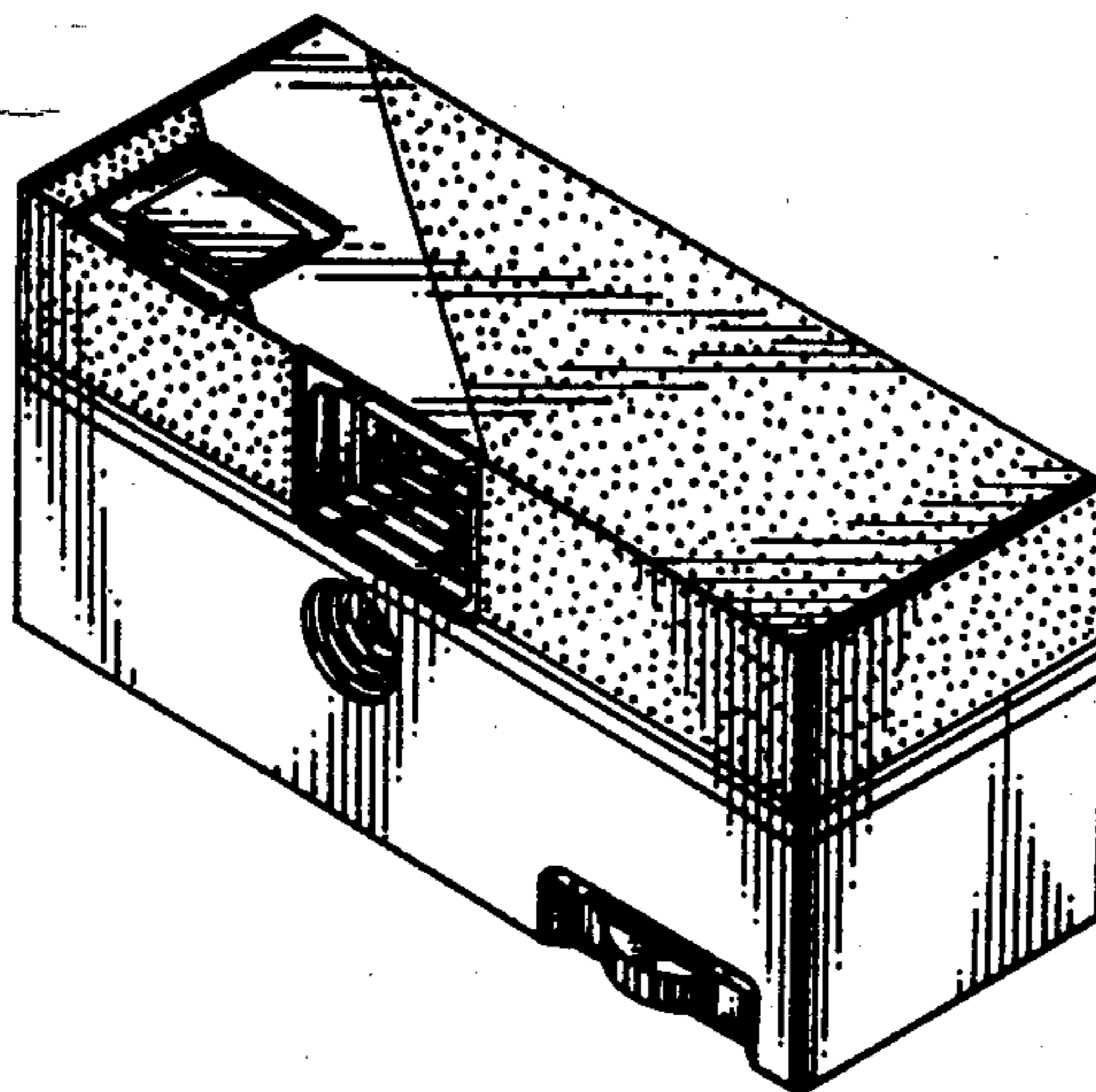

FIG. 1

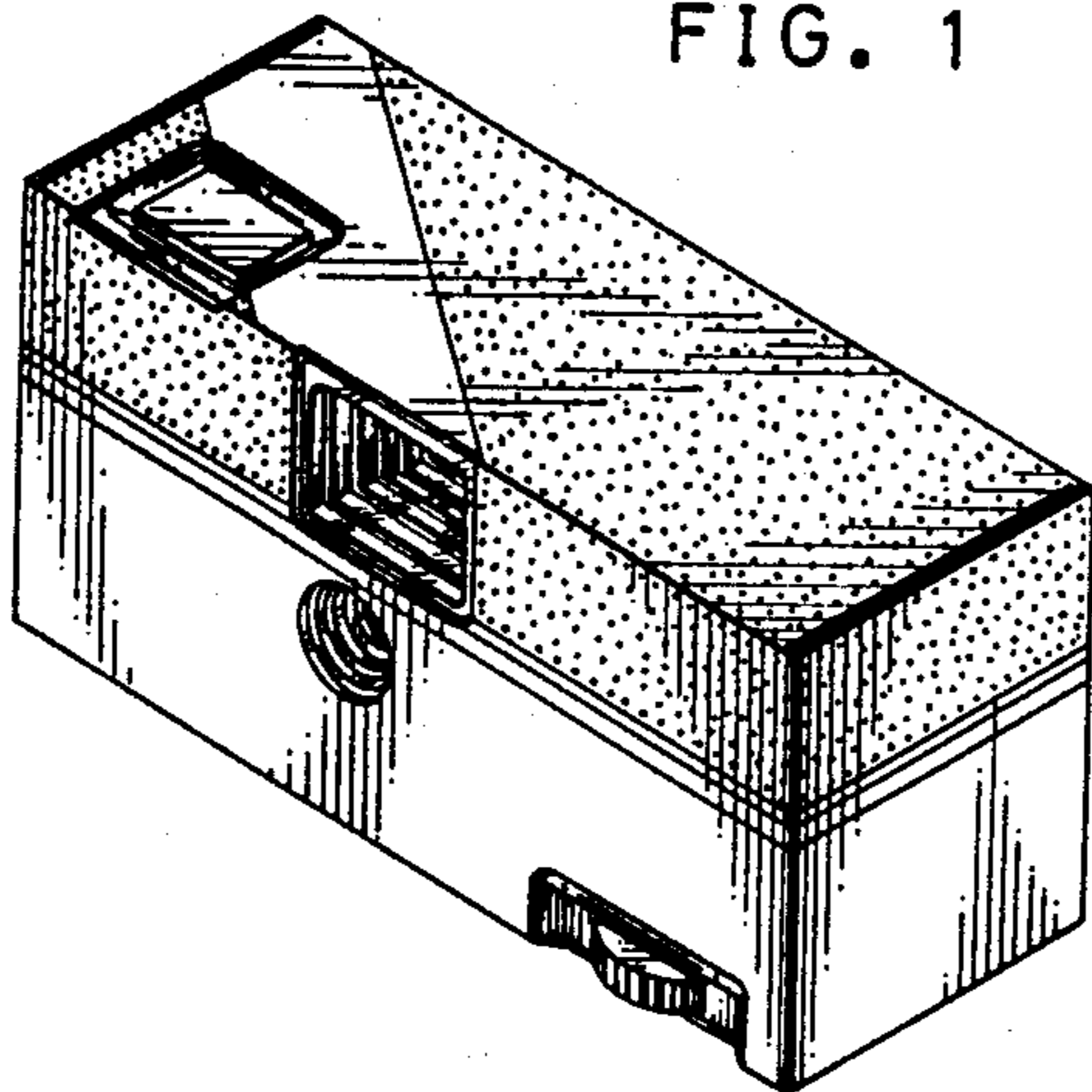

FIG. 2

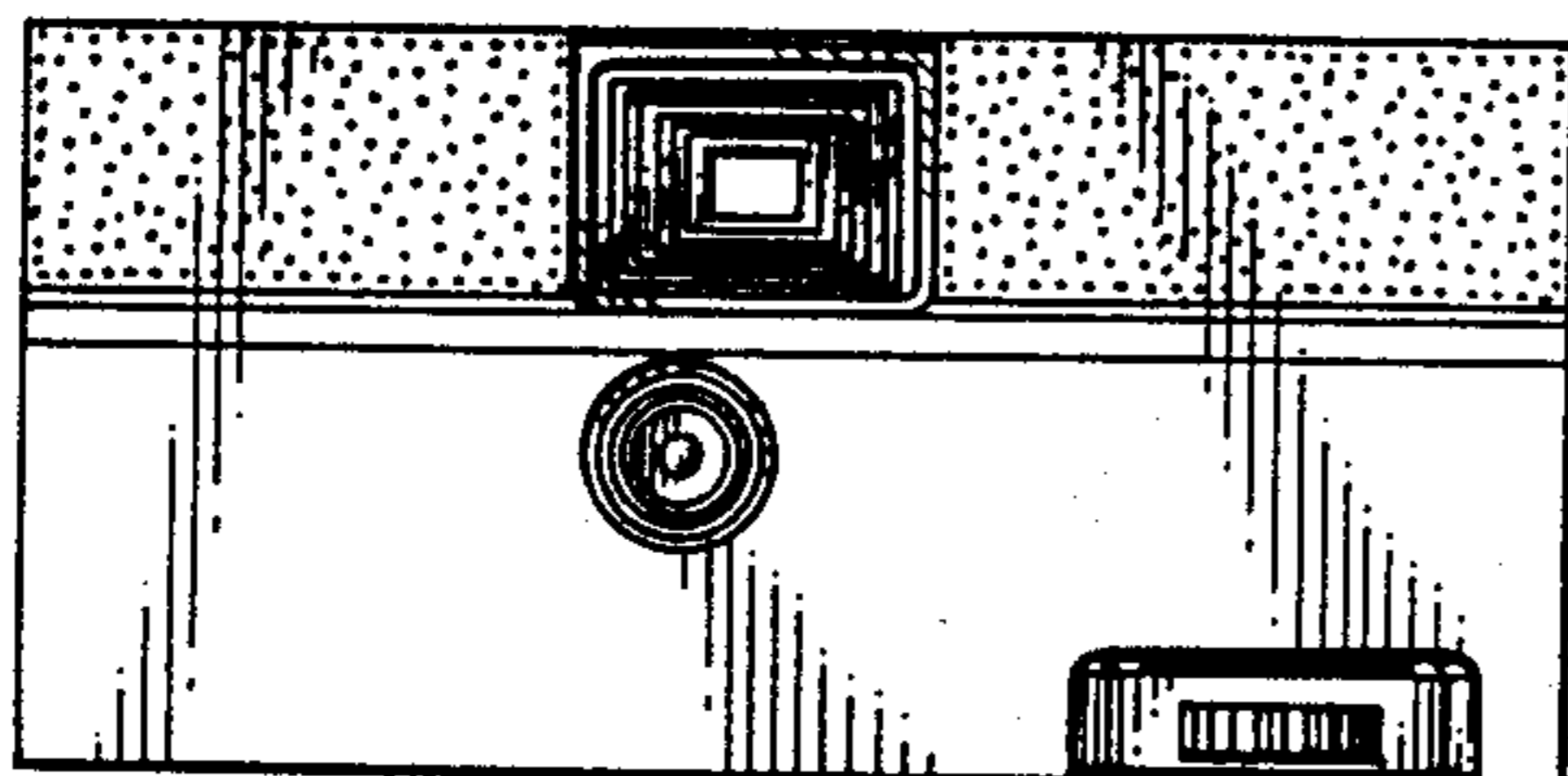

FIG. 3

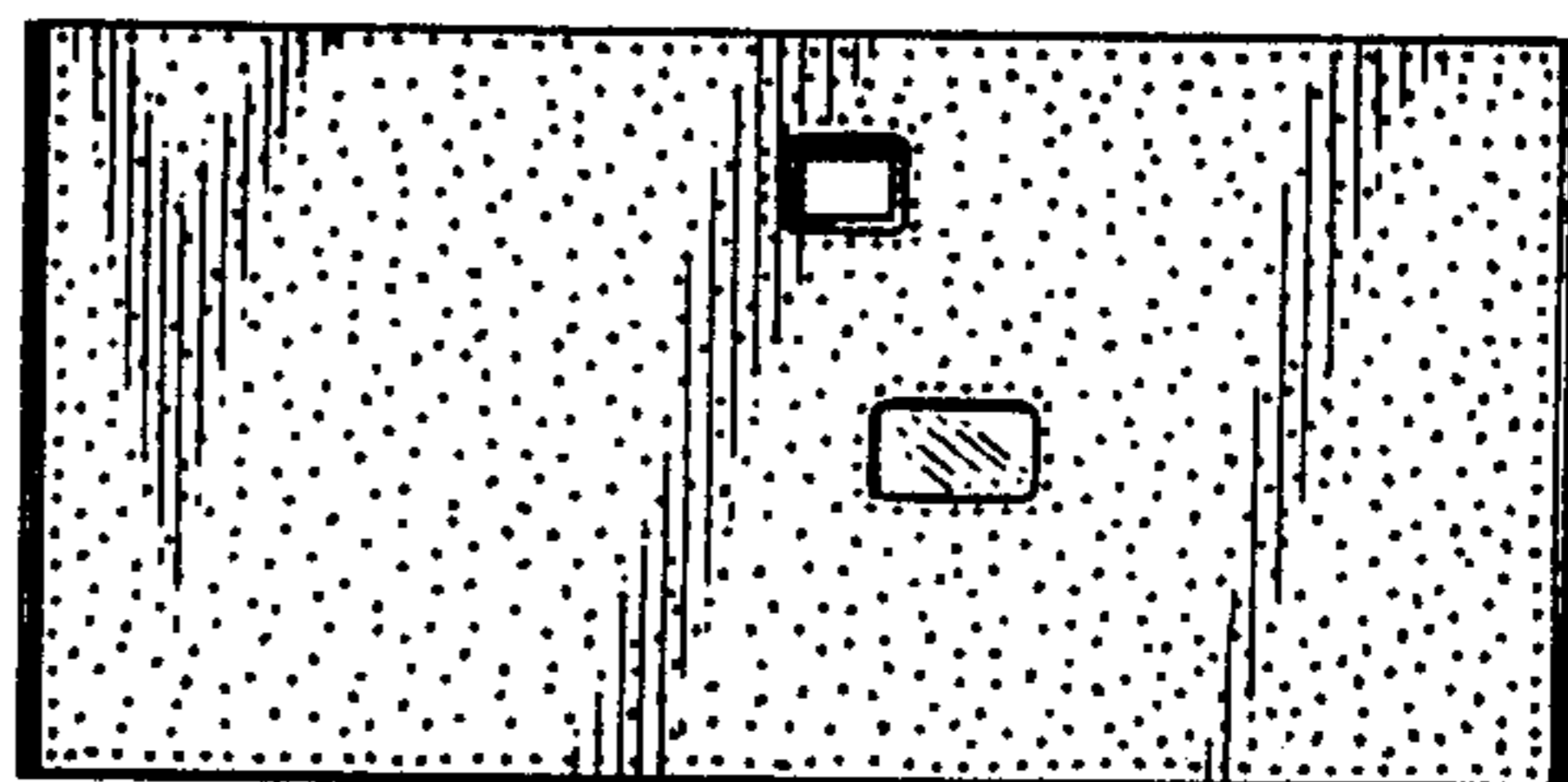

FIG. 4

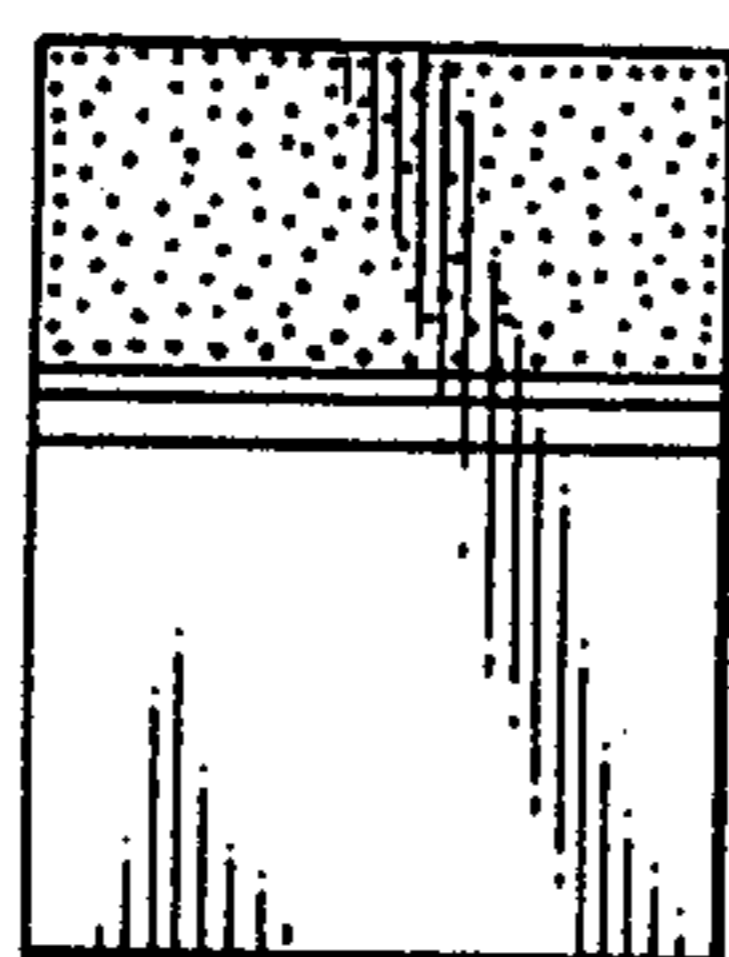

FIG. 5

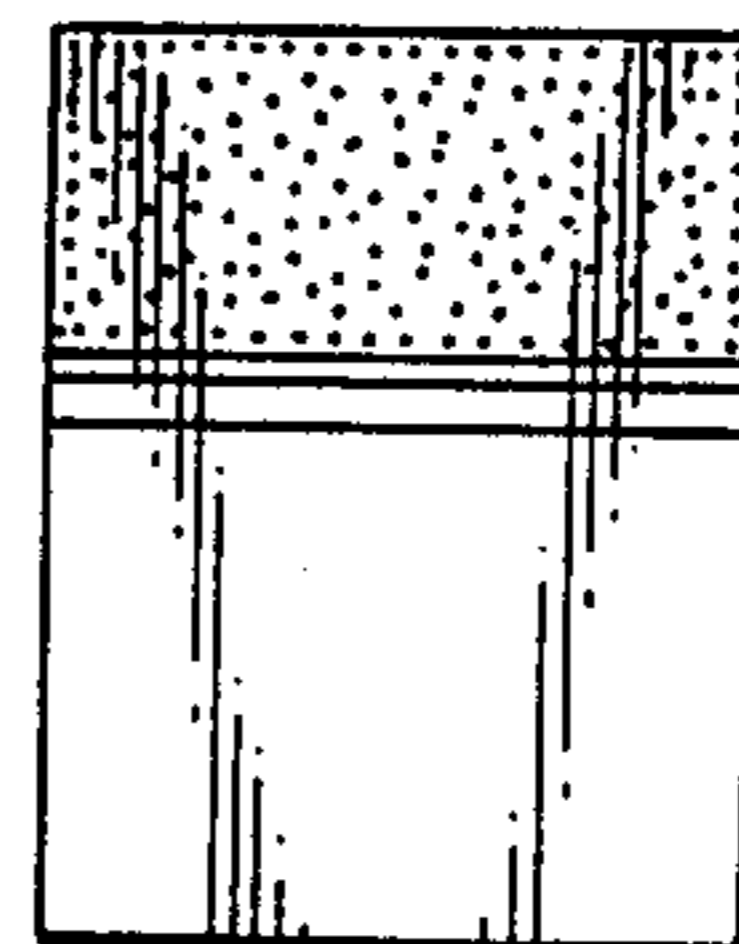

FIG. 6

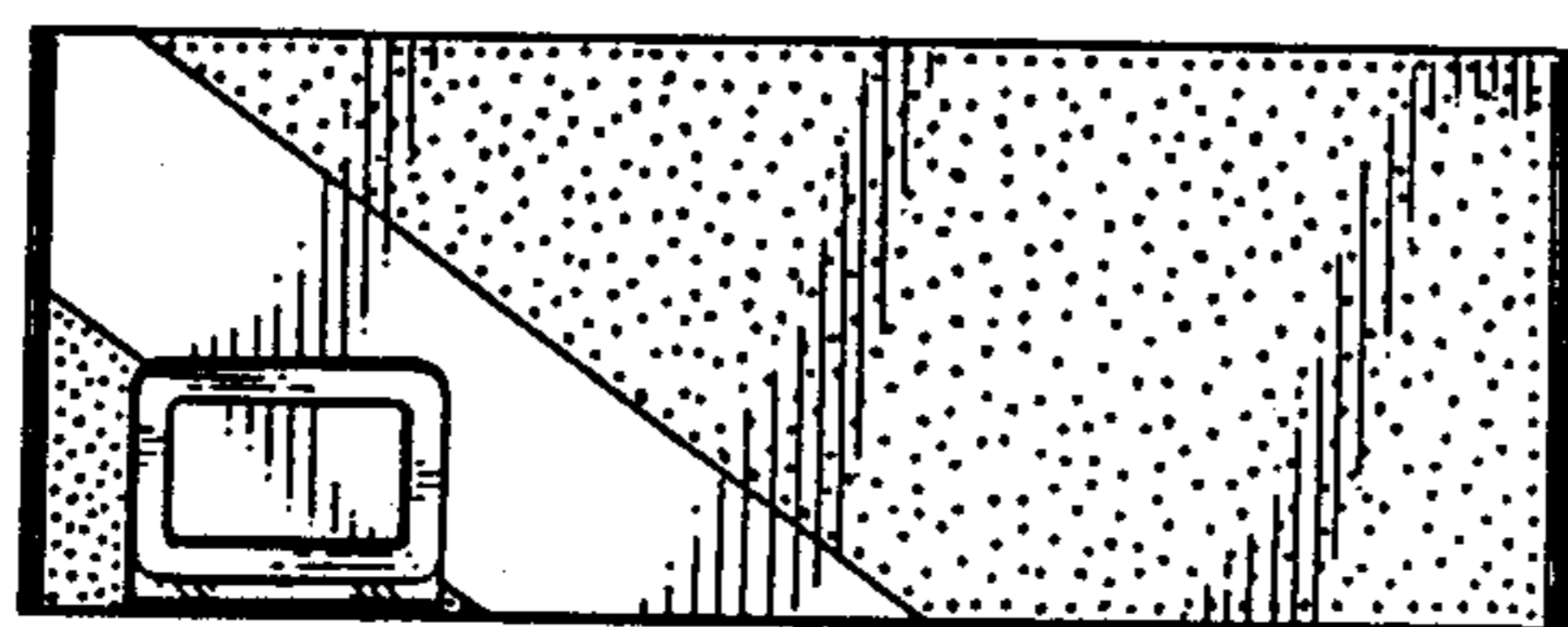

FIG. 7

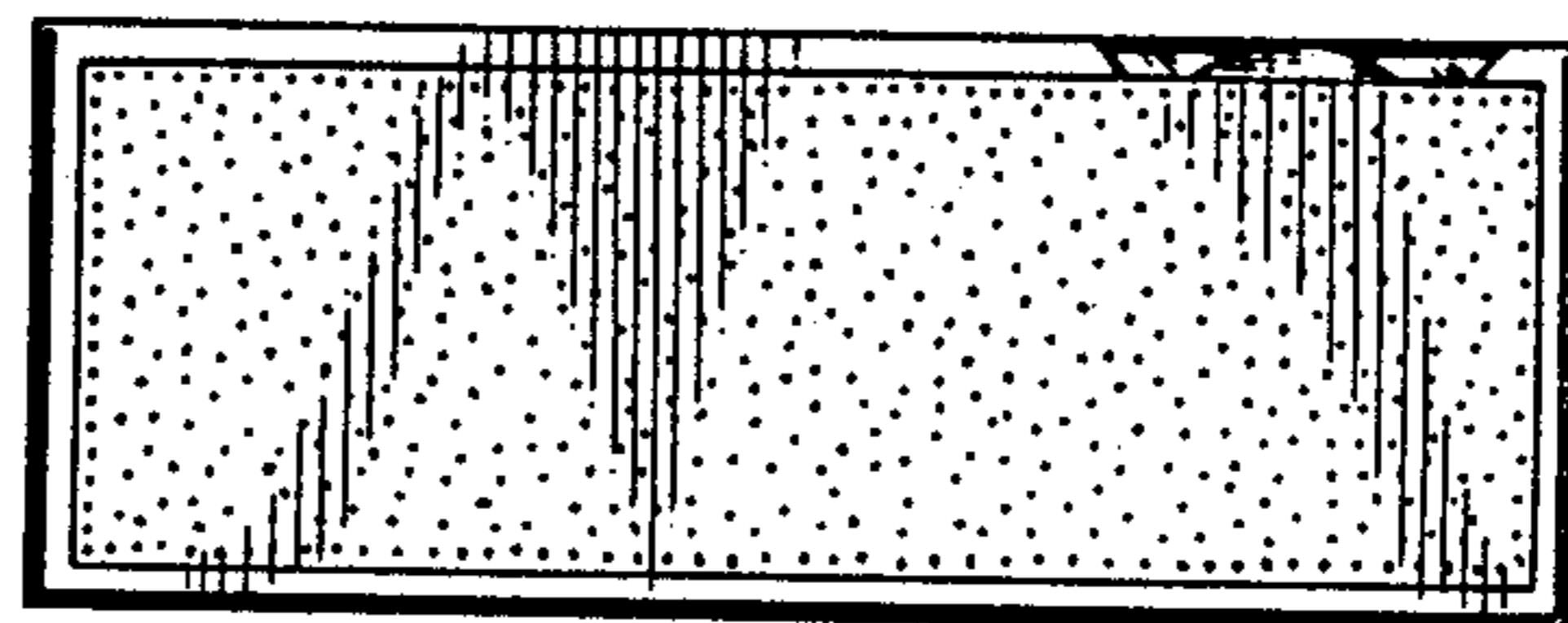

FIG. 8

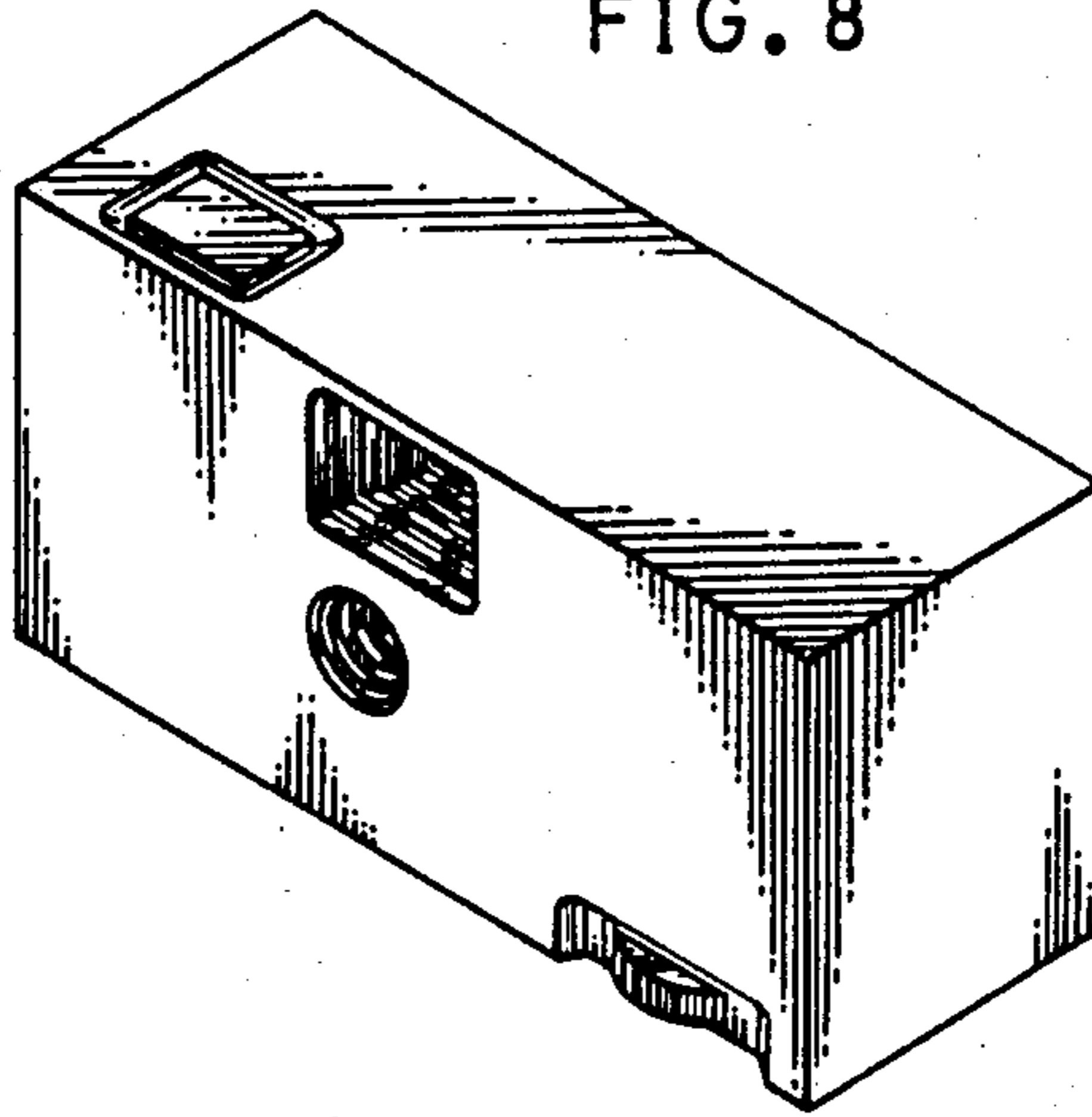

FIG. 9

