

[54] POWER DRIVEN BRUSH FOR CLEANING CARPETS, FLOORS OR THE LIKE

D. 233,209 10/1974 Terrailon ..... D4/100  
3,594,841 7/1971 Kieves ..... 15/106

[75] Inventors: Fusao Fushiya; Yoshio Yokoyama, both of Anjo, Japan

FOREIGN PATENT DOCUMENTS

90908 11/1937 Sweden ..... 15/106

[73] Assignee: Makita Electric Works Ltd., Anjo, Japan

Primary Examiner—Susan J. Lucas  
Assistant Examiner—Lavone D. Tabor  
Attorney, Agent, or Firm—Lahive & Cockfield

[\*\*] Term: 14 Years

[21] Appl. No.: 57,002

[57] CLAIM

[22] Filed: Jun. 1, 1987

The ornamental design for a power driven brush for cleaning carpets, floors or the like, as shown.

[30] Foreign Application Priority Data

DESCRIPTION

Dec. 2, 1986 [JP] Japan ..... 61-47727

[52] U.S. Cl. .... D4/100; D37/17; D37/38

FIG. 1 is a perspective view of a power driven brush for cleaning carpets, floors or the like showing our new design;

[58] Field of Search ..... D4/100; D32/15, 17, D32/18-19, 35, 38-39; 15/104 R, 106, 159 R

FIG. 2 is a right side elevational view thereof;  
FIG. 3 is a left side elevational view thereof;  
FIG. 4 is a top plan view thereof;  
FIG. 5 is a bottom plan view thereof;  
FIG. 6 is a front elevational view thereof; and  
FIG. 7 is a rear elevational view thereof.

[56] References Cited

U.S. PATENT DOCUMENTS

D. 207,632 5/1967 Anderson ..... D32/17

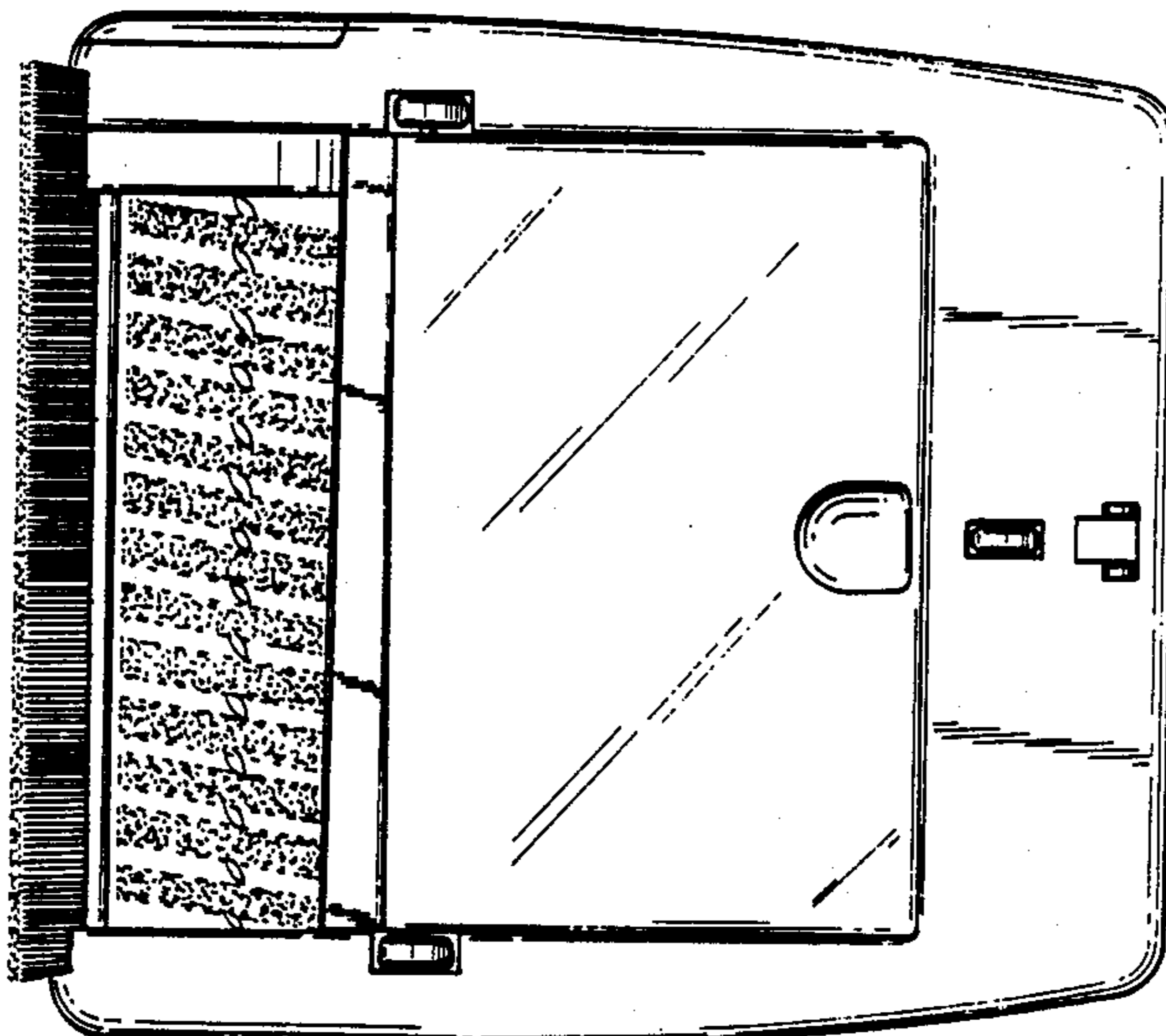
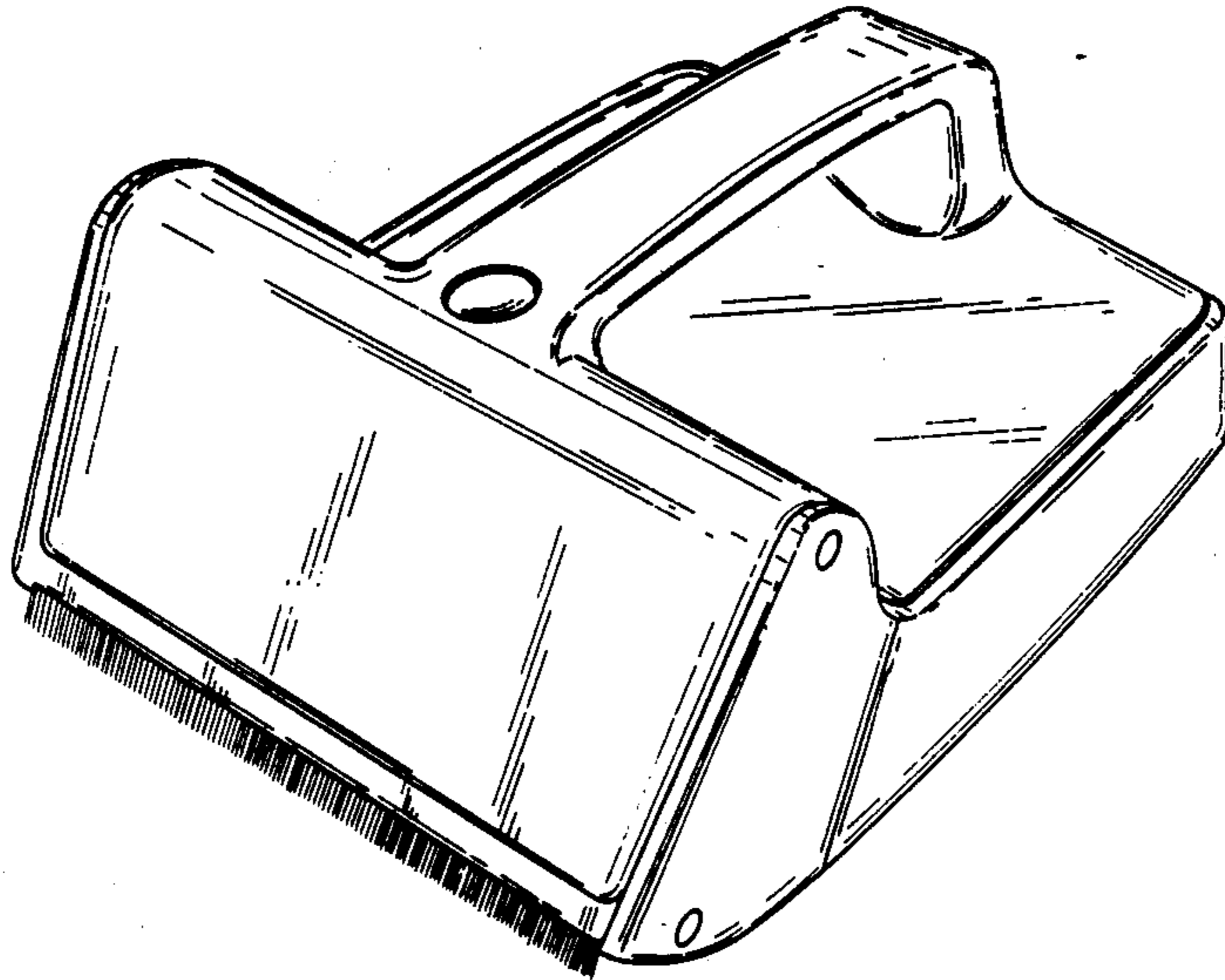

FIG. 1

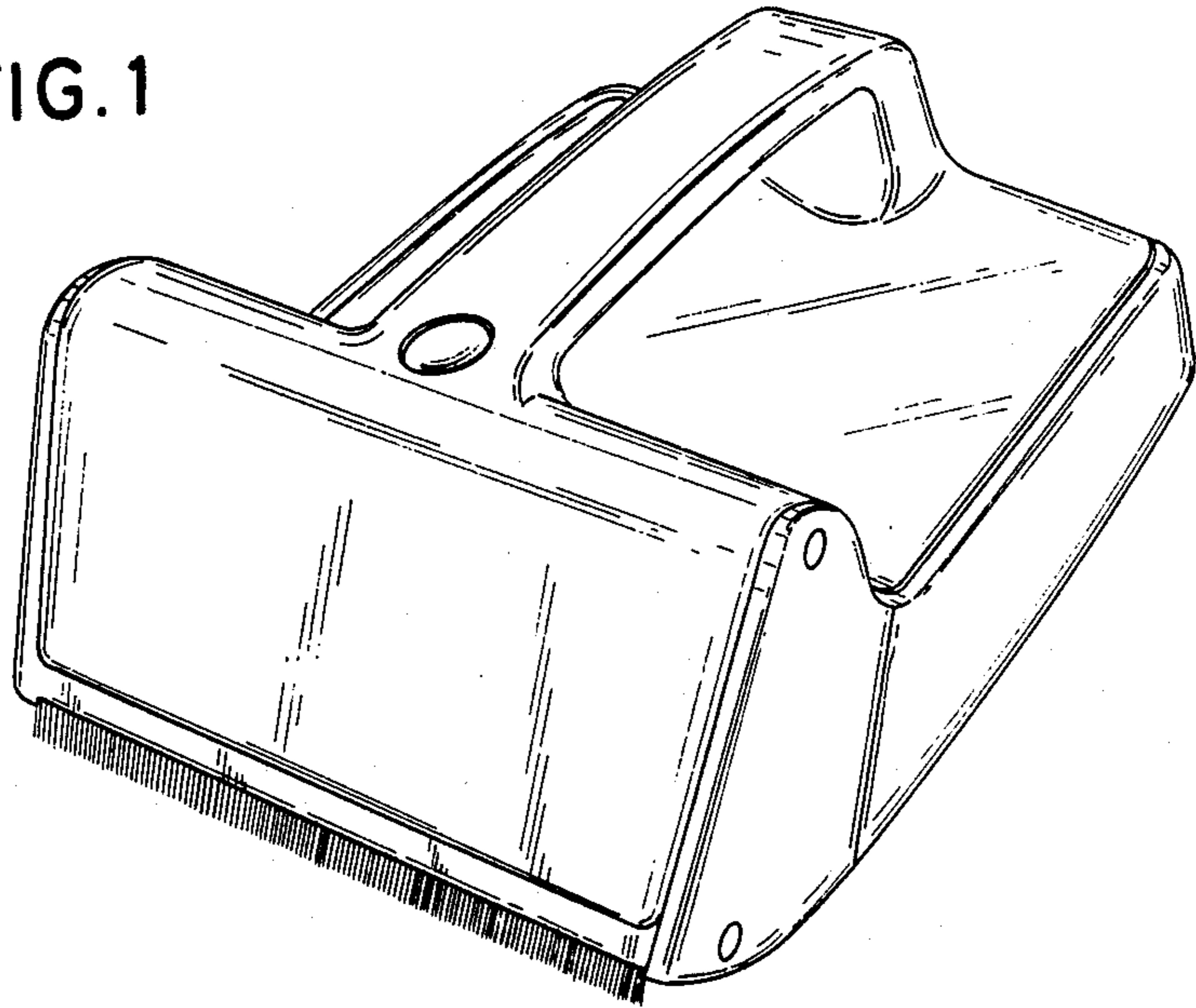

FIG. 2

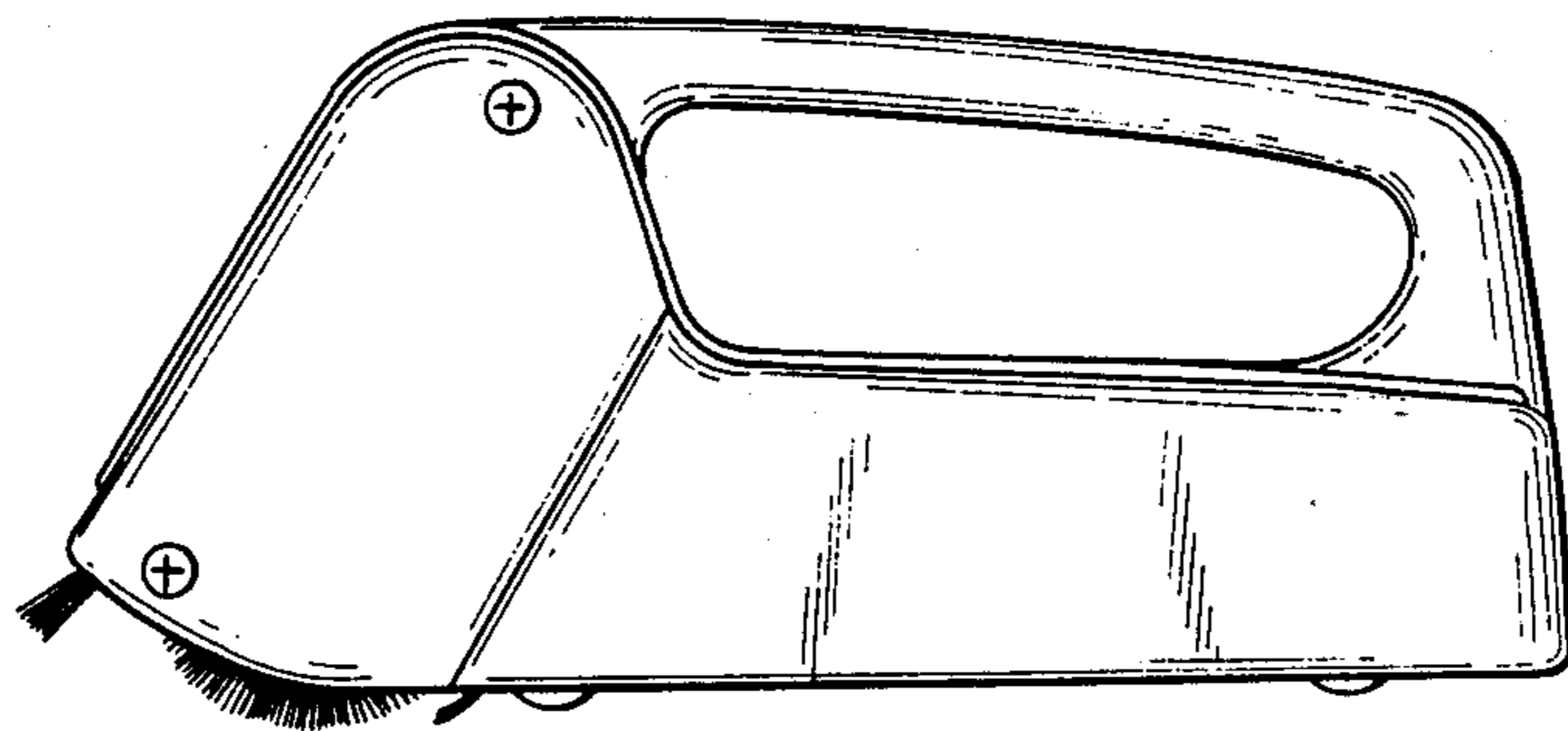

FIG. 3

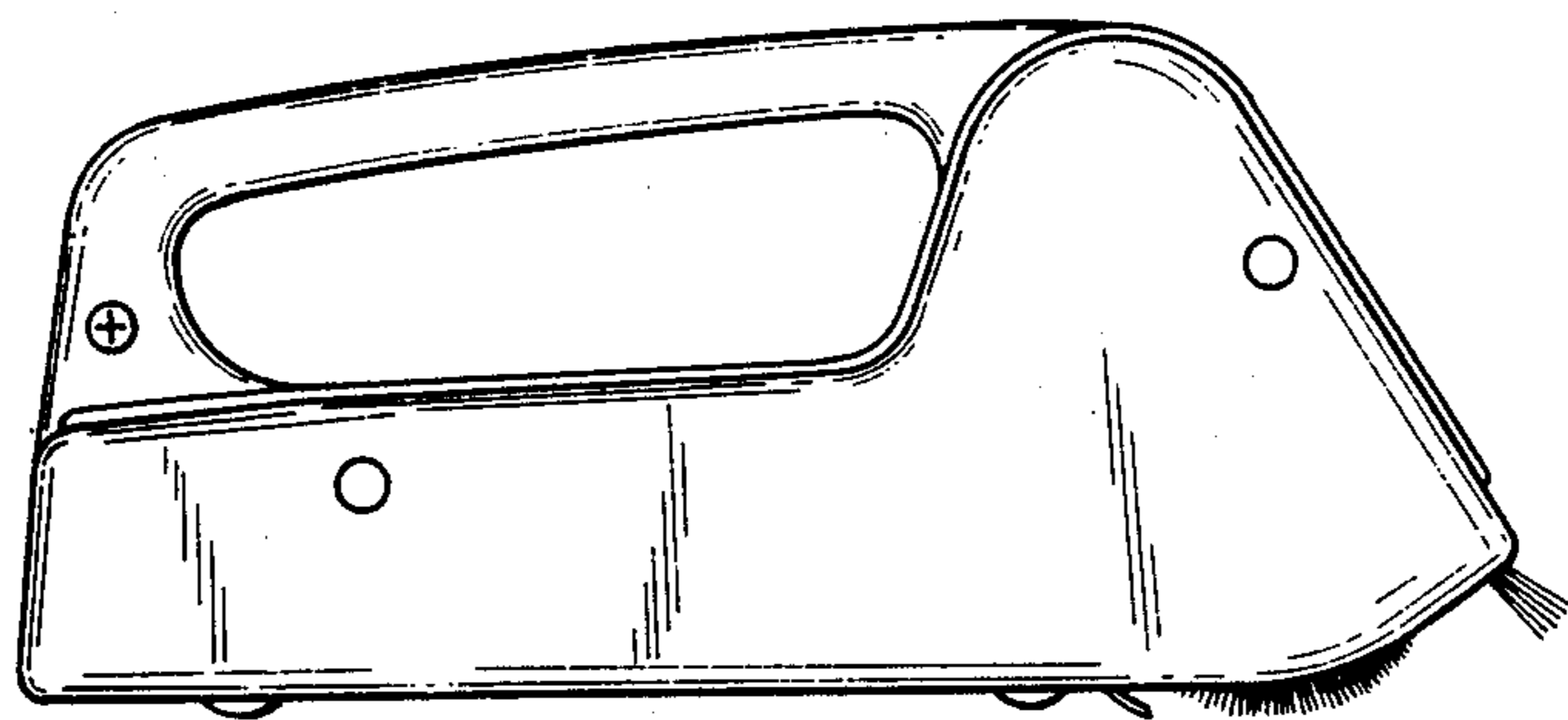

FIG. 4

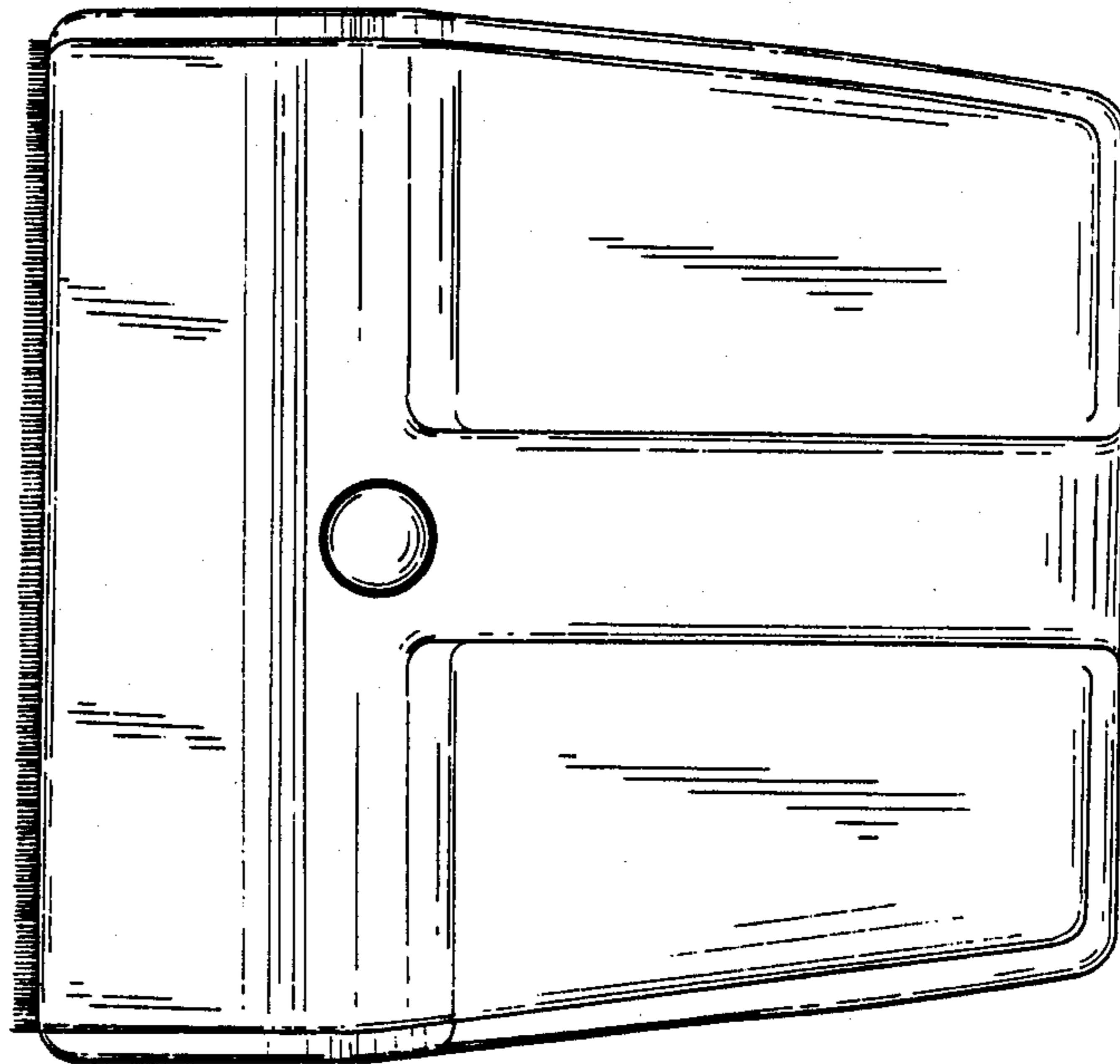

FIG. 5

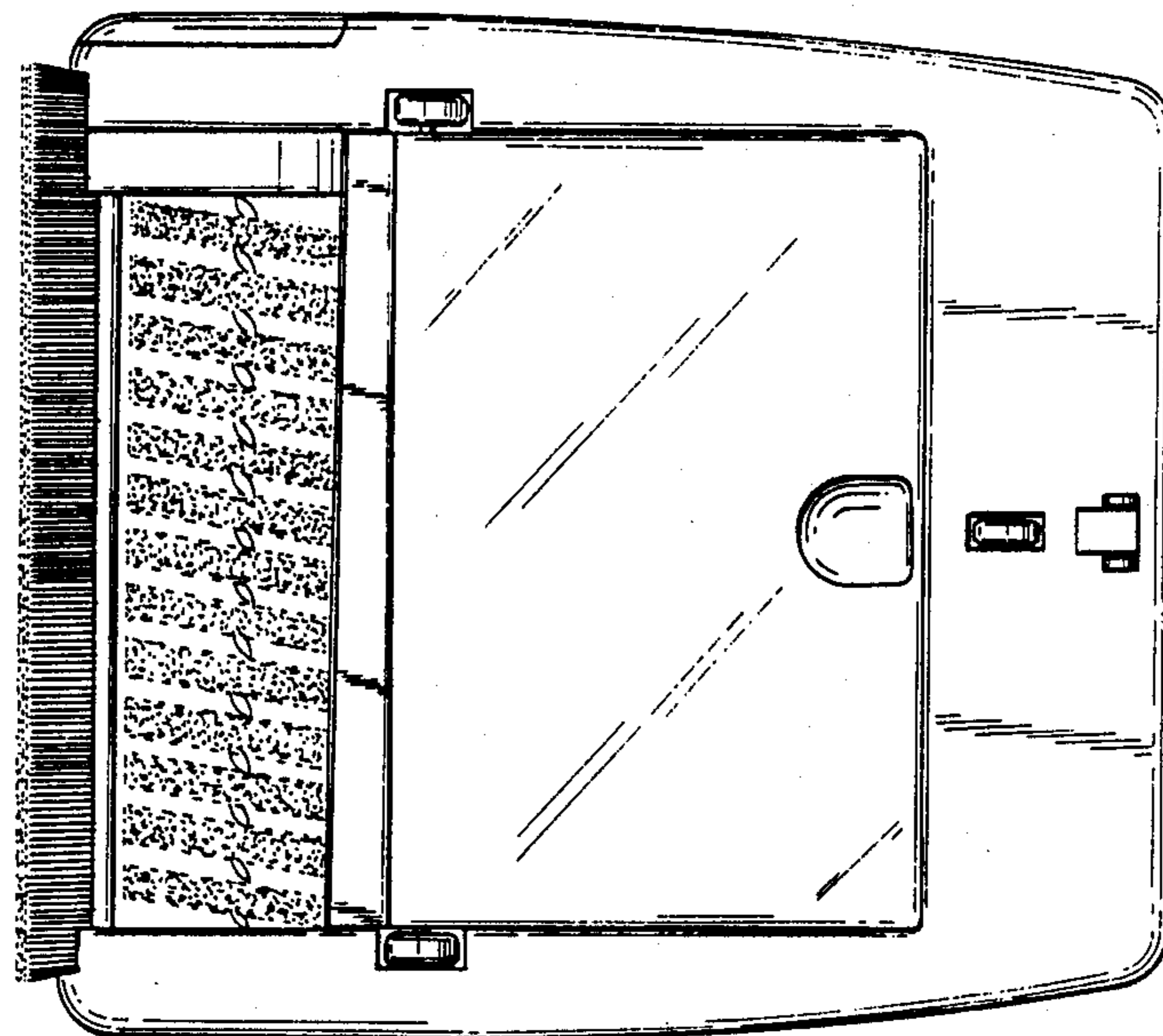

FIG. 6

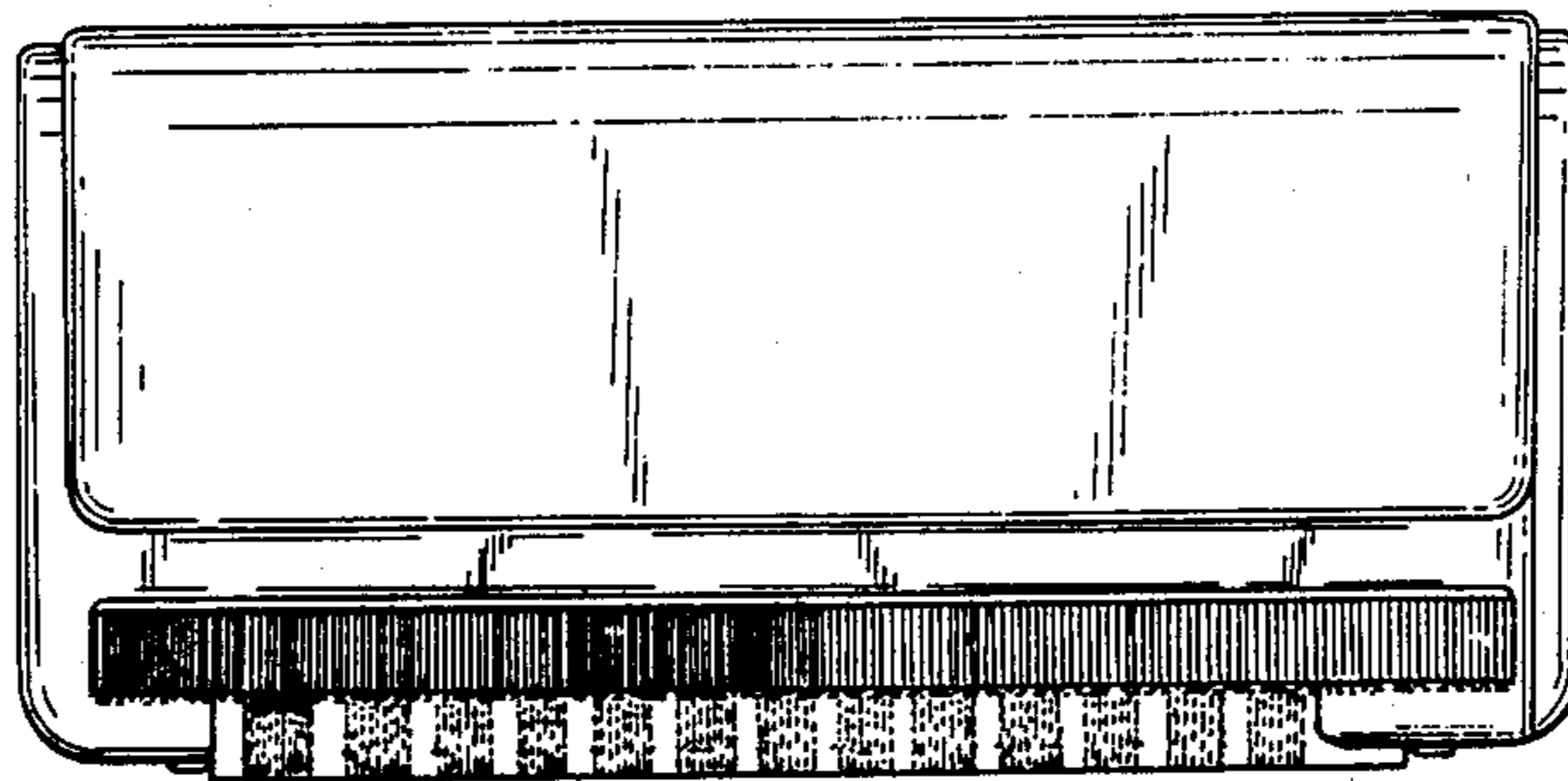

FIG. 7

