

[54] REVOLVING GOLF TEE

[76] Inventor: Jim Fox, 2225 Buchtel Blvd., Ste. 607, Denver, Colo. 80210

[\*\*] Term: 14 Years

[21] Appl. No.: 82,102

[22] Filed: Aug. 6, 1987

Related U.S. Application Data

[63] Continuation-in-part of Ser. No. 707,815, Mar. 4, 1985.

[52] U.S. Cl. .... D21/208

[58] Field of Search ..... D21/234; 273/33, 184 B, 273/197 R, 204, 208, 209

References Cited

U.S. PATENT DOCUMENTS

2,277,918 3/1942 Lehman ..... 273/204

3,743,298 7/1973 Reynolds ..... 273/204  
4,004,814 1/1977 Blair ..... 273/204

Primary Examiner—Bernard Ansher  
Assistant Examiner—David Jeo  
Attorney, Agent, or Firm—James E. Pittenger

[57] CLAIM

The ornamental design for a revolving golf tee, as shown and described.

DESCRIPTION

FIG. 1 is a top-right side perspective view of a revolving golf tee showing my new design;  
FIG. 2 is a bottom plan view thereof;  
FIG. 3 is a top plan view thereof;  
FIG. 4 is a left side elevational view thereof;  
FIG. 5 is a rear elevational view thereof;  
FIG. 6 is a right side elevational view thereof; and  
FIG. 7 is a front elevational view thereof.

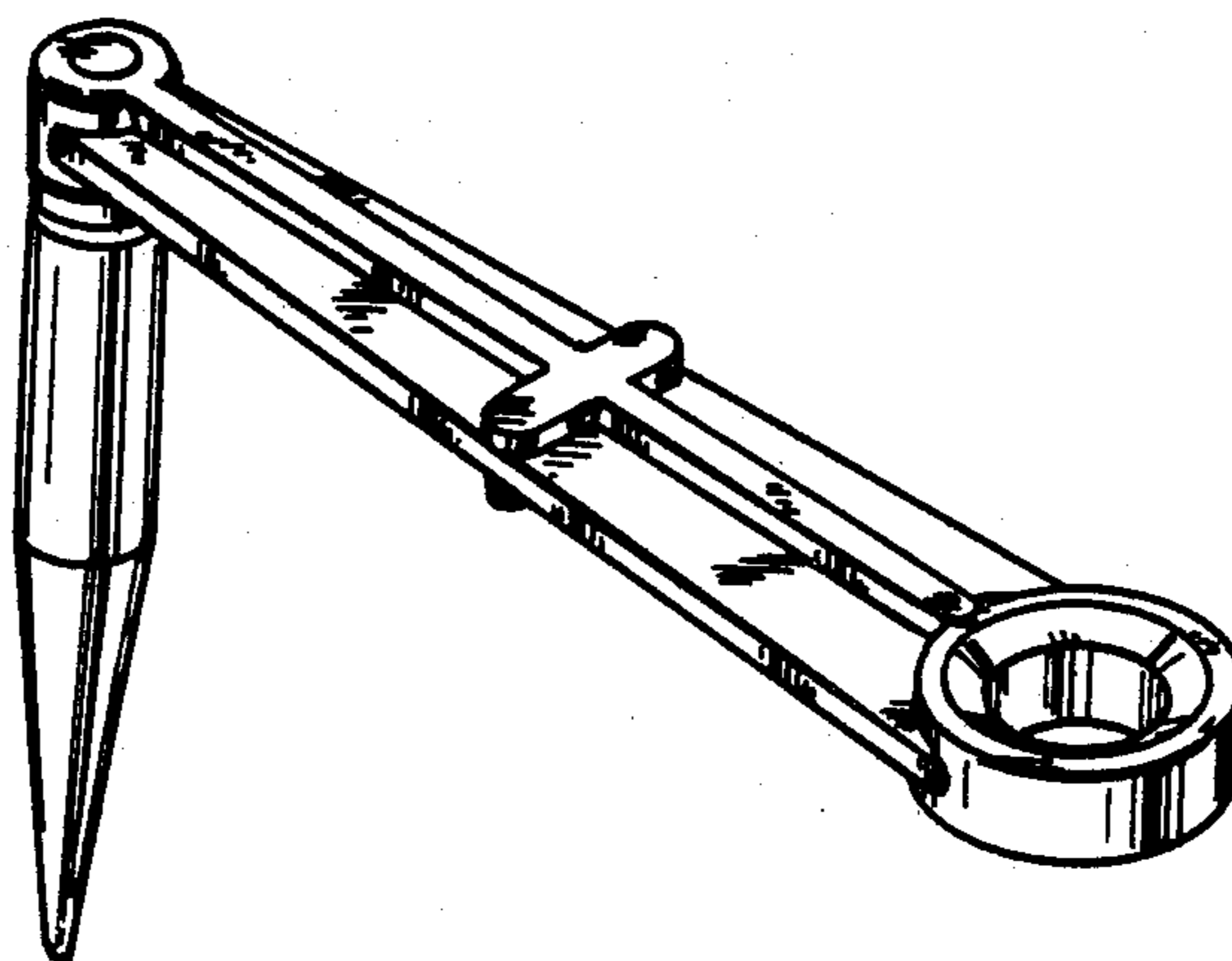

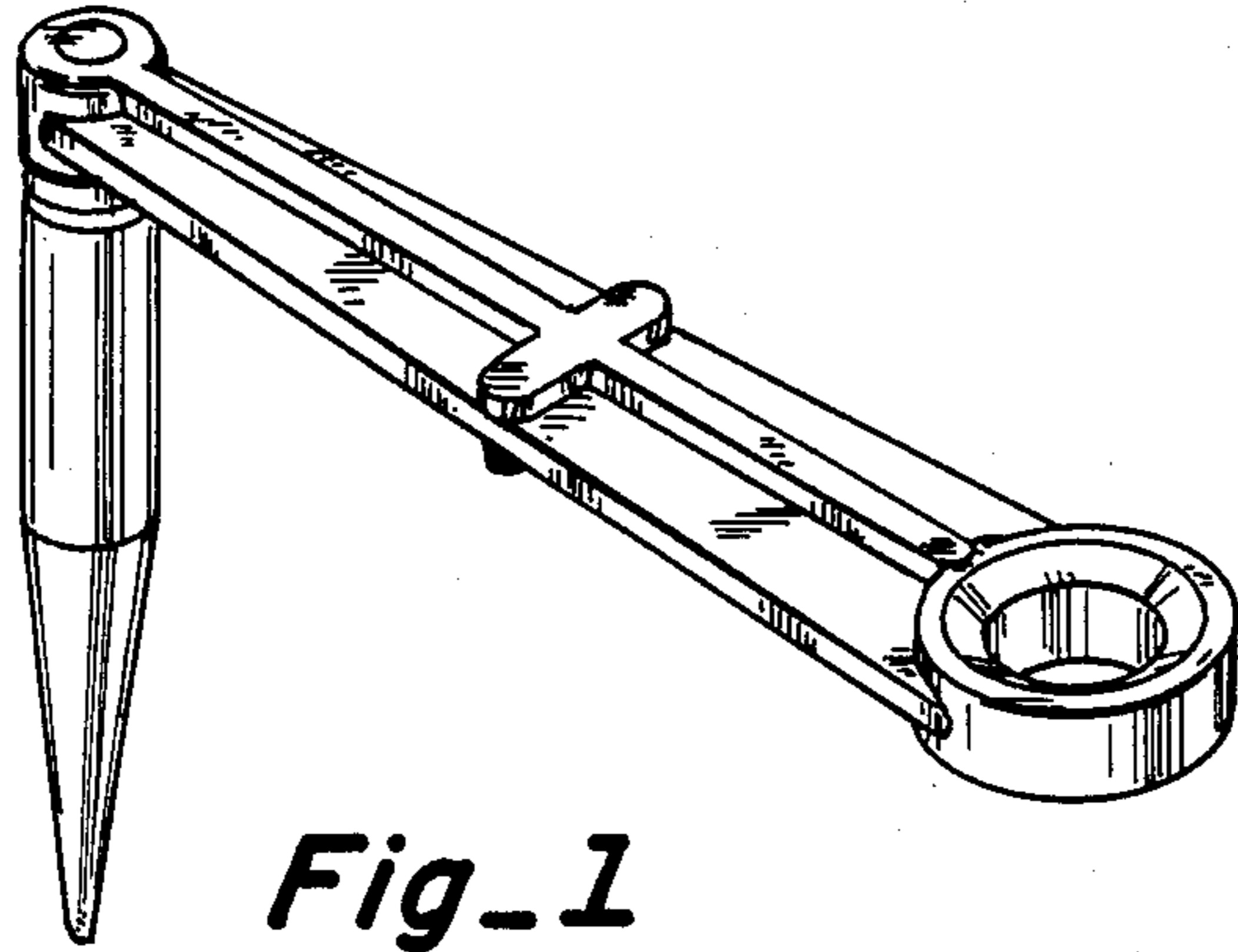

*Fig\_1*

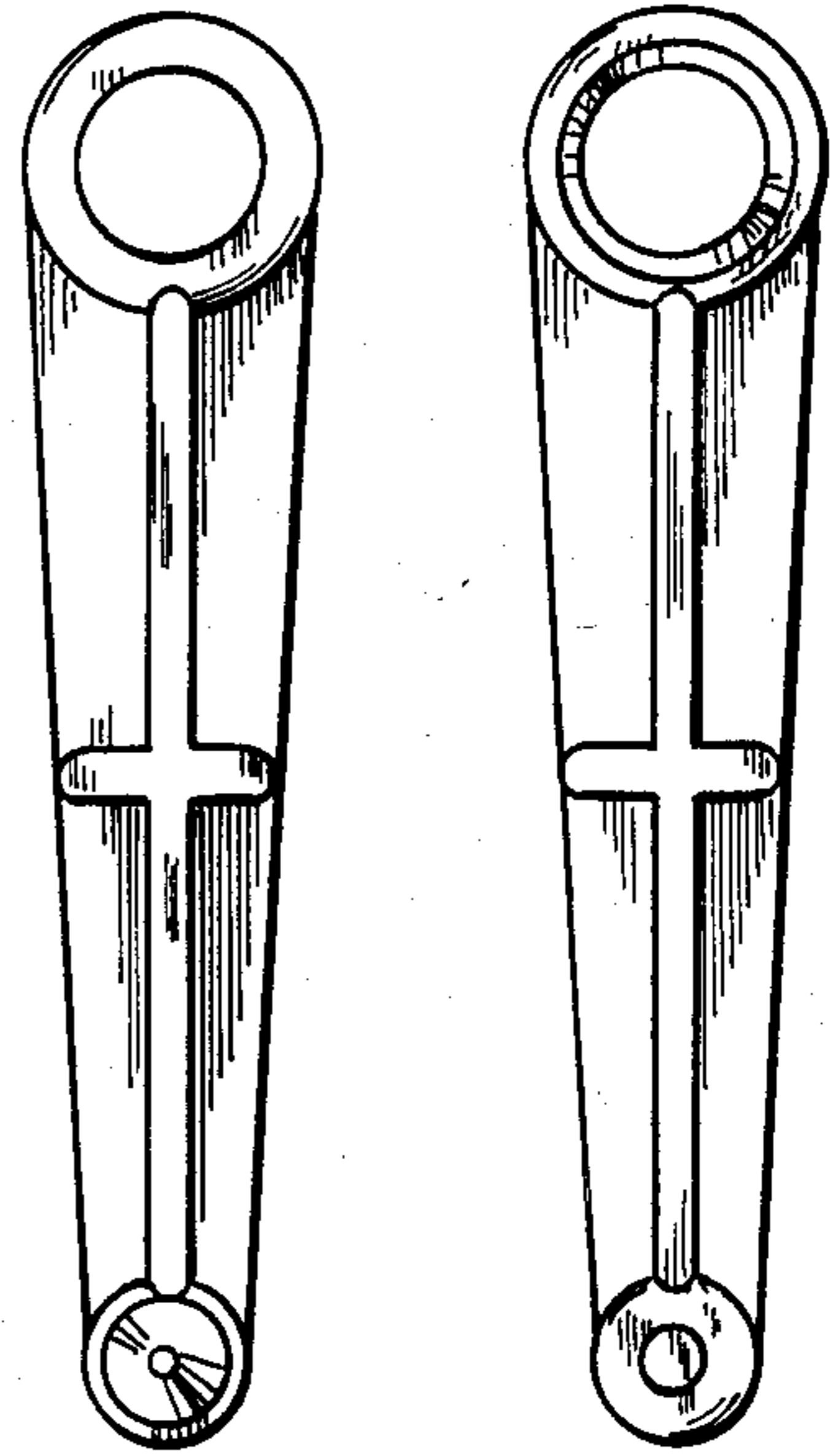

*Fig\_2 Fig\_3*

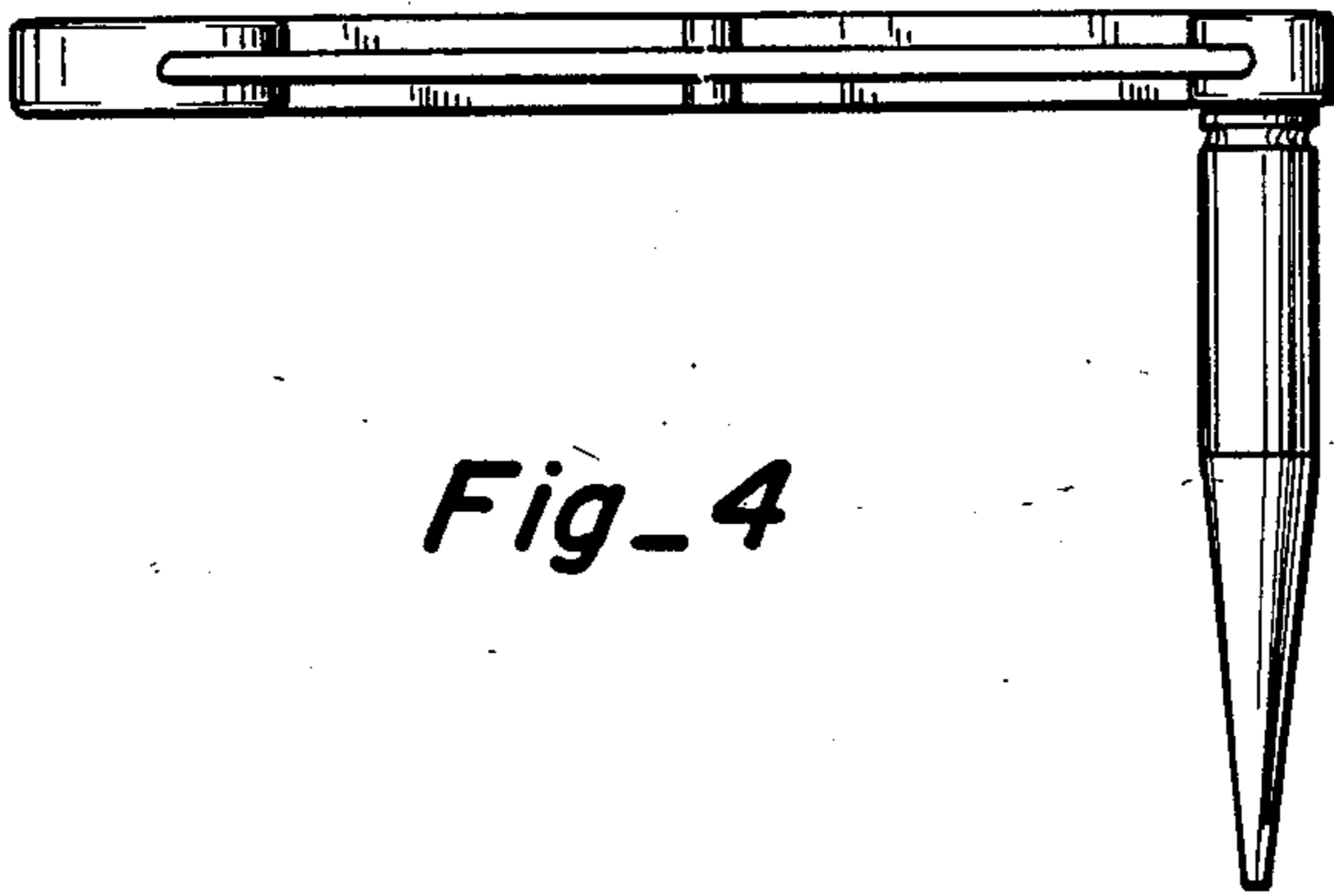

*Fig\_4*

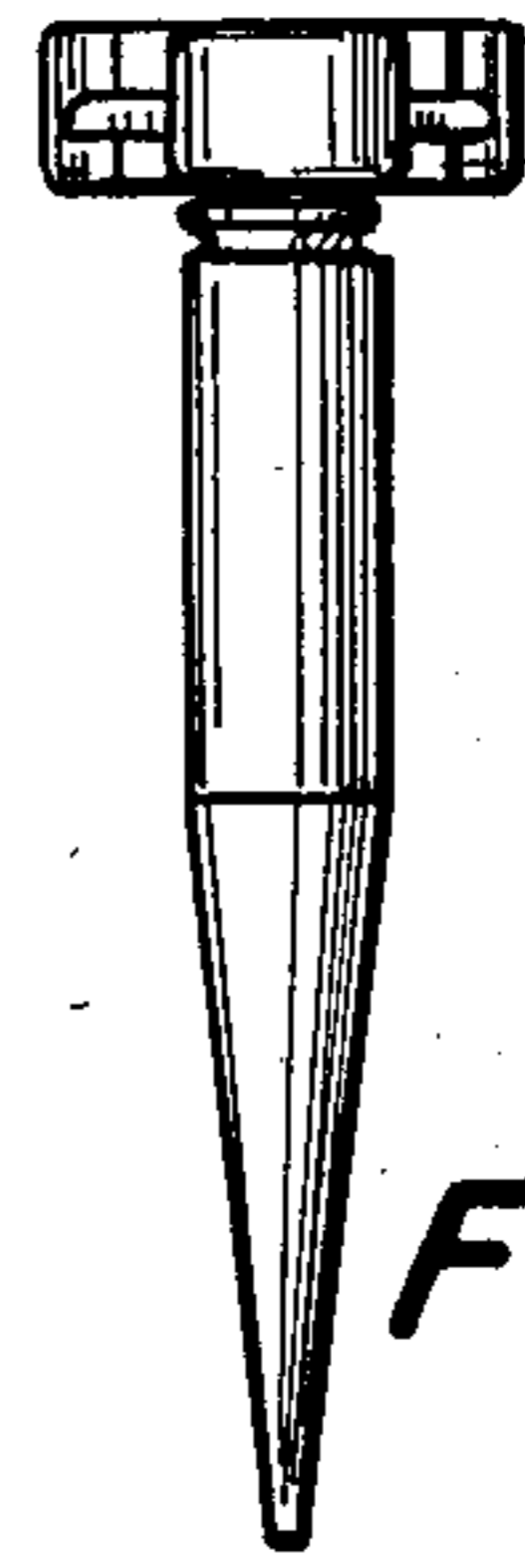

*Fig\_5*

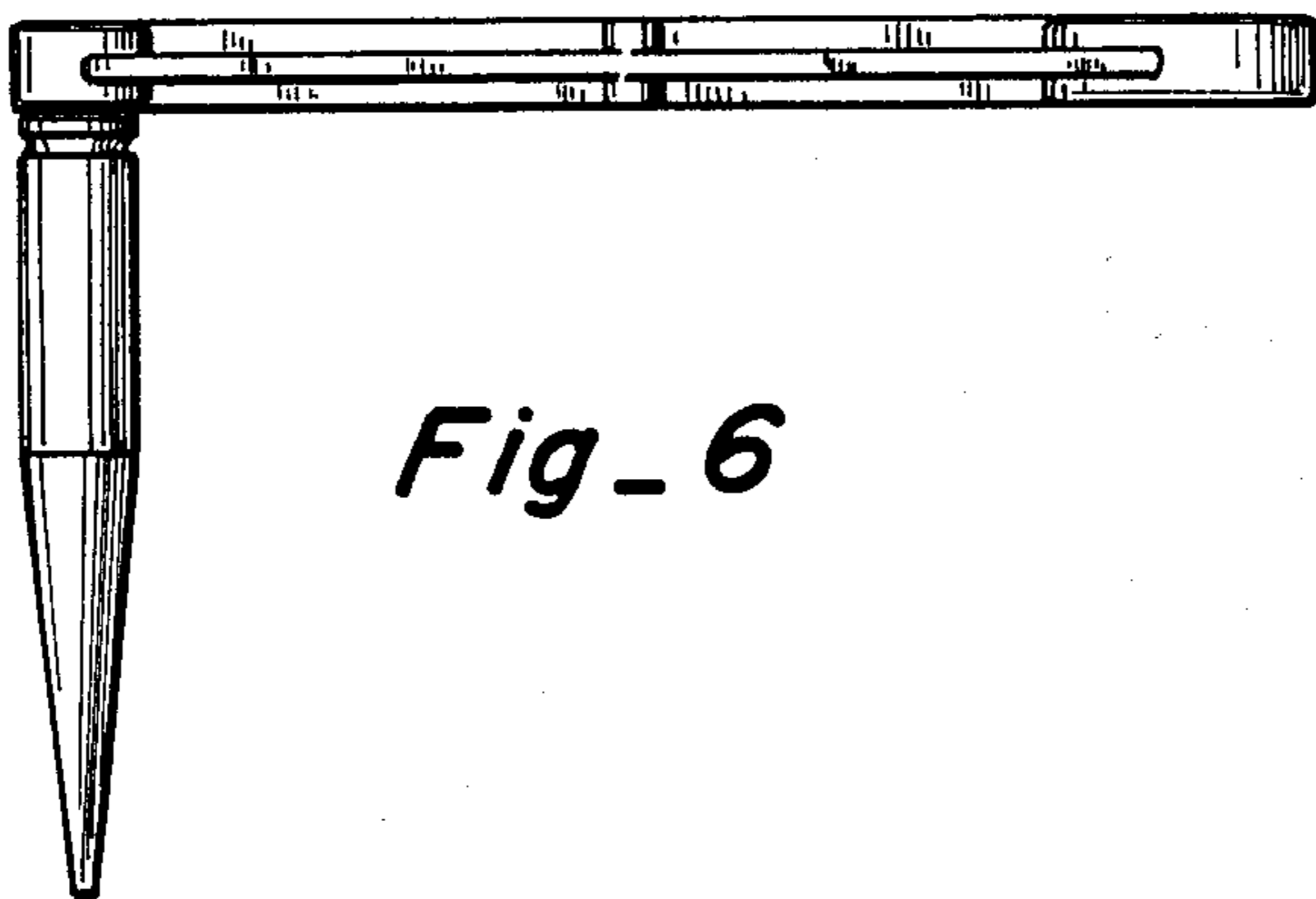

*Fig\_6*

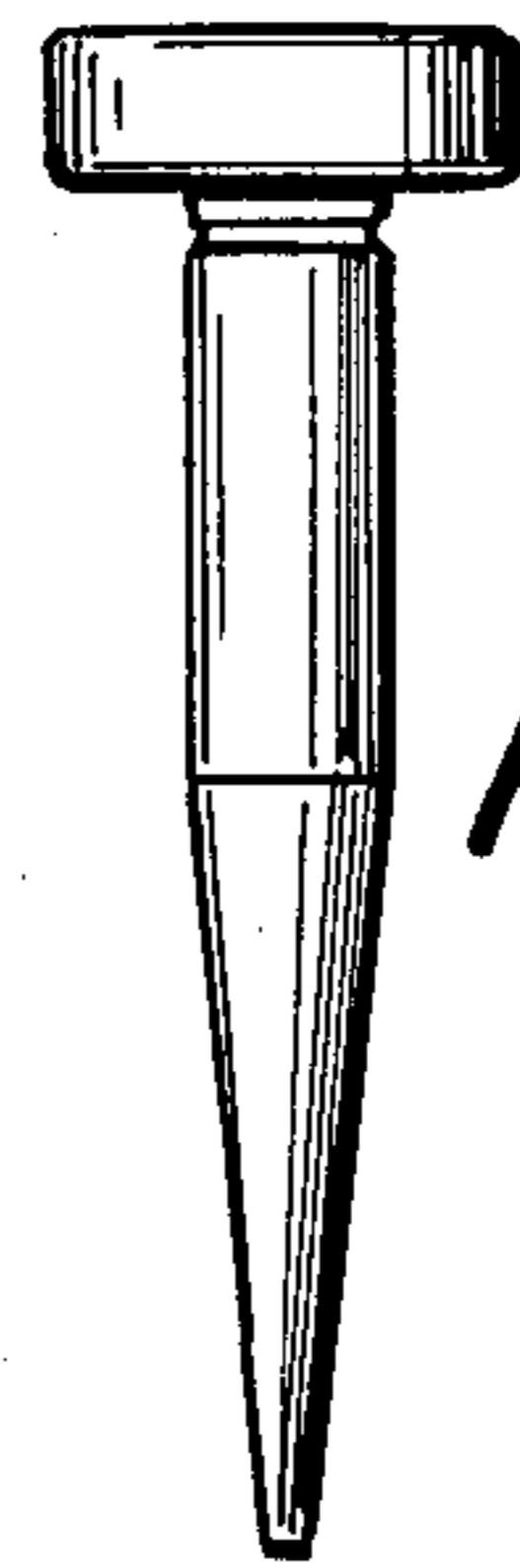

*Fig\_7*