

[54] COMBINATION SEAT AND HANDBAG

Primary Examiner—Nelson C. Holtje
Assistant Examiner—Ann Hunt

[76] Inventors: Patricia Pestuglicci, 354 Broadway;
Peggy Mosley, 350 Broadway, both
of Menands, N.Y. 12204

[57] CLAIM

The ornamental design for a combination seat and hand-
bag, as shown and described.

[**] Term: 14 Years

DESCRIPTION

[21] Appl. No.: 933,918

FIG. 1 is a perspective view of the combination seat and
handbag showing our new design,
FIG. 2 is an end elevational view, the opposite end view
being a mirror image thereof,
FIG. 3 is a side elevational view, the opposite side view
being a mirror image thereof,
FIG. 4 is a bottom plan view,
FIG. 5 is a perspective view of the combination seat and
handbag in open position; and
FIG. 6 is a side elevational view on a reduced scale, the
broken lines depicting a chair being shown for illustra-
tive purposes only.

[22] Filed: Nov. 24, 1986

[52] U.S. Cl. D6/601

[58] Field of Search D6/595, 596, 601, 610,
D6/611

[56] References Cited

U.S. PATENT DOCUMENTS

- D. 258,187 2/1981 Robbins D6/596
- D. 276,954 1/1985 Kruger D6/596
- D. 293,868 1/1988 Paletta et al. D6/611

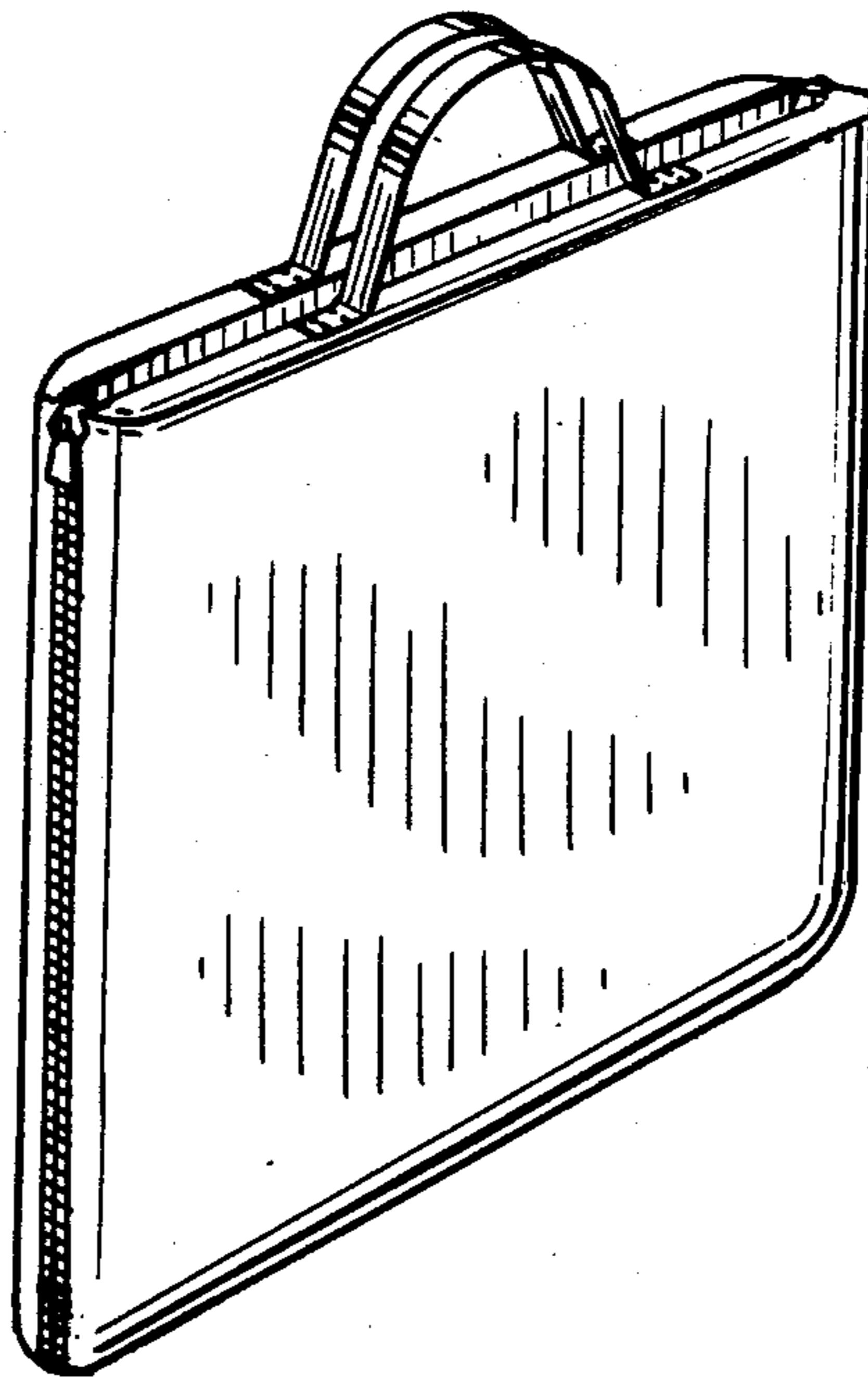

Fig. 1.

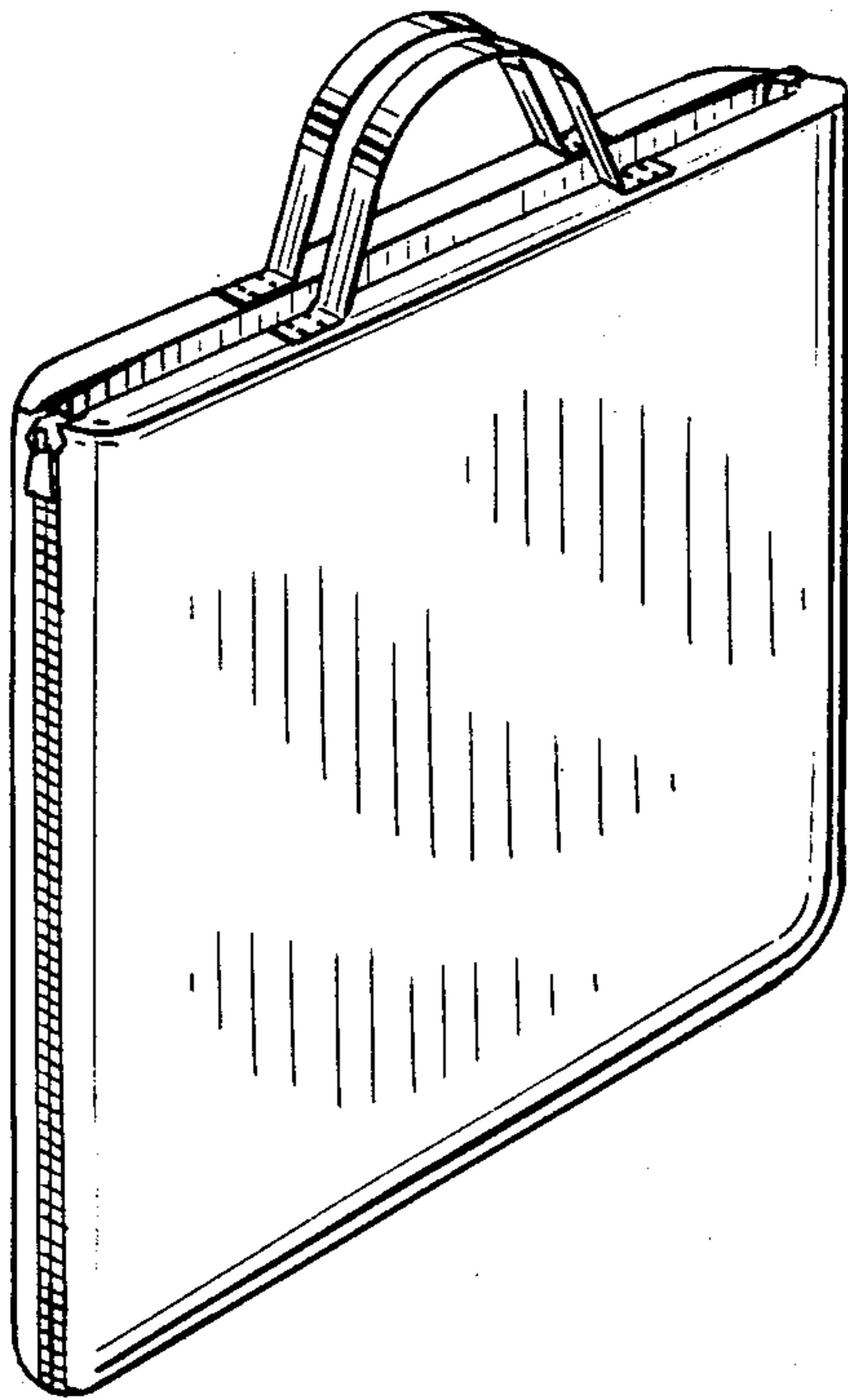

Fig. 2.

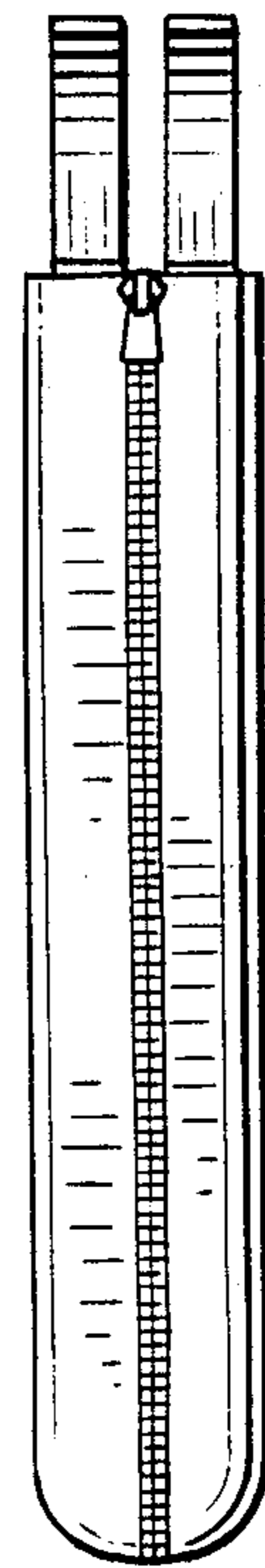

Fig. 3.

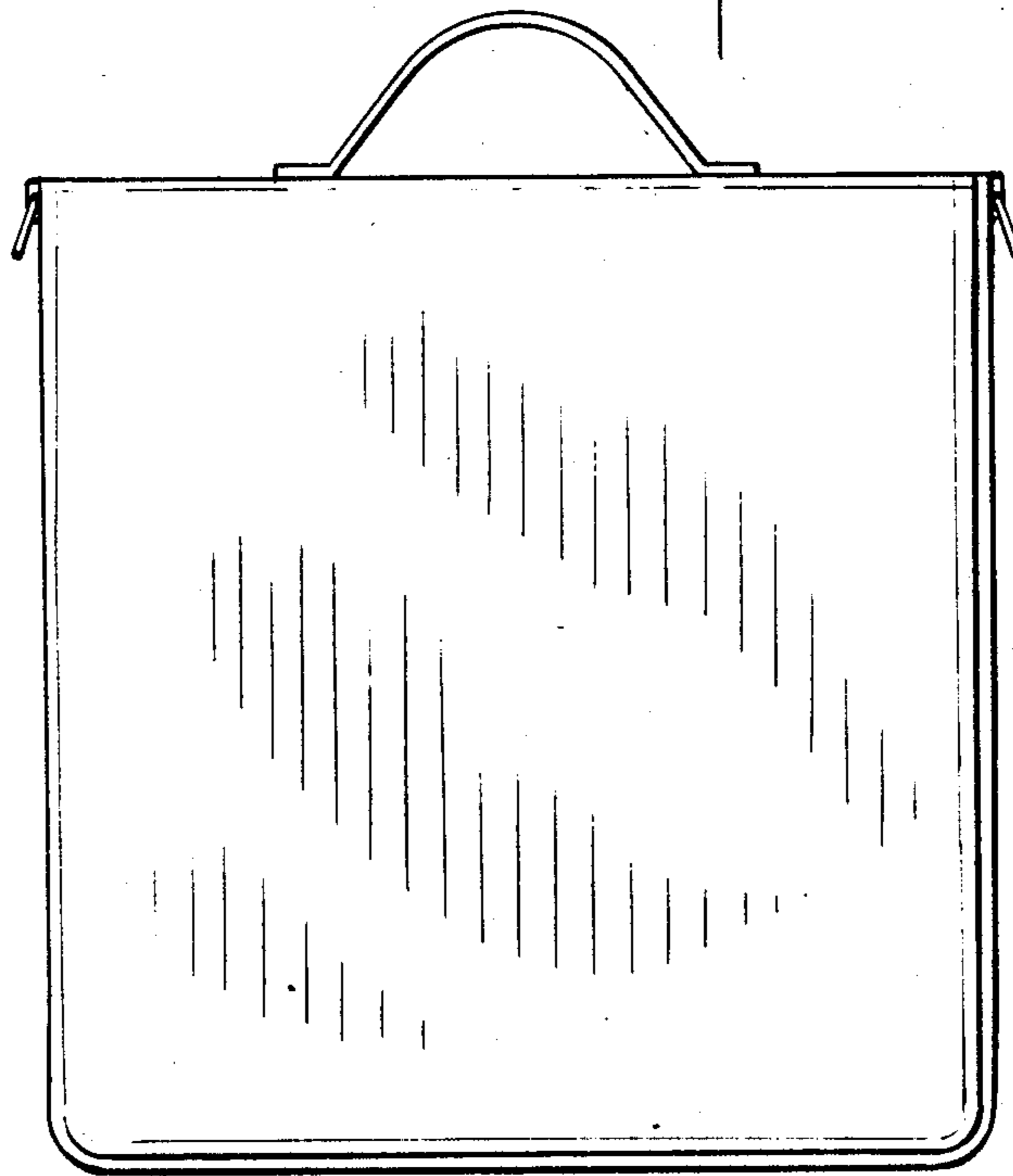
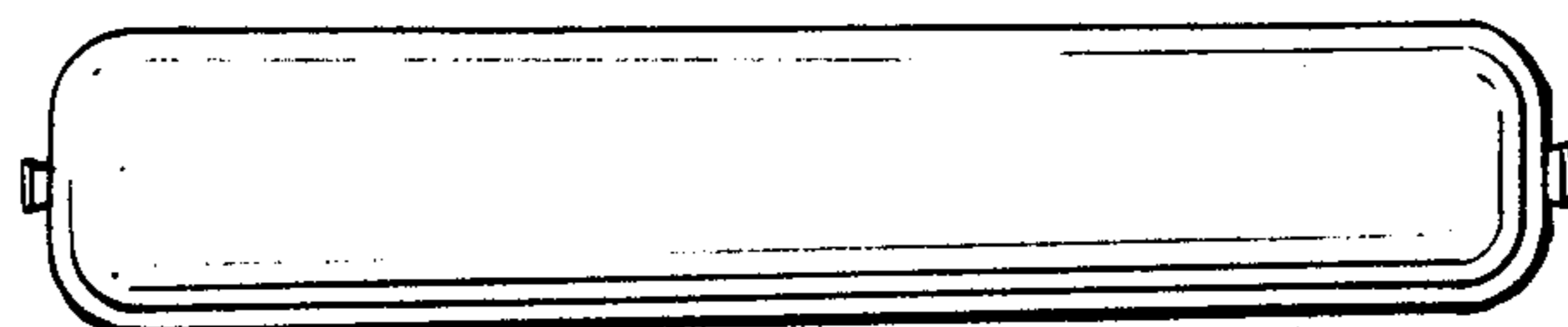

Fig. 4.



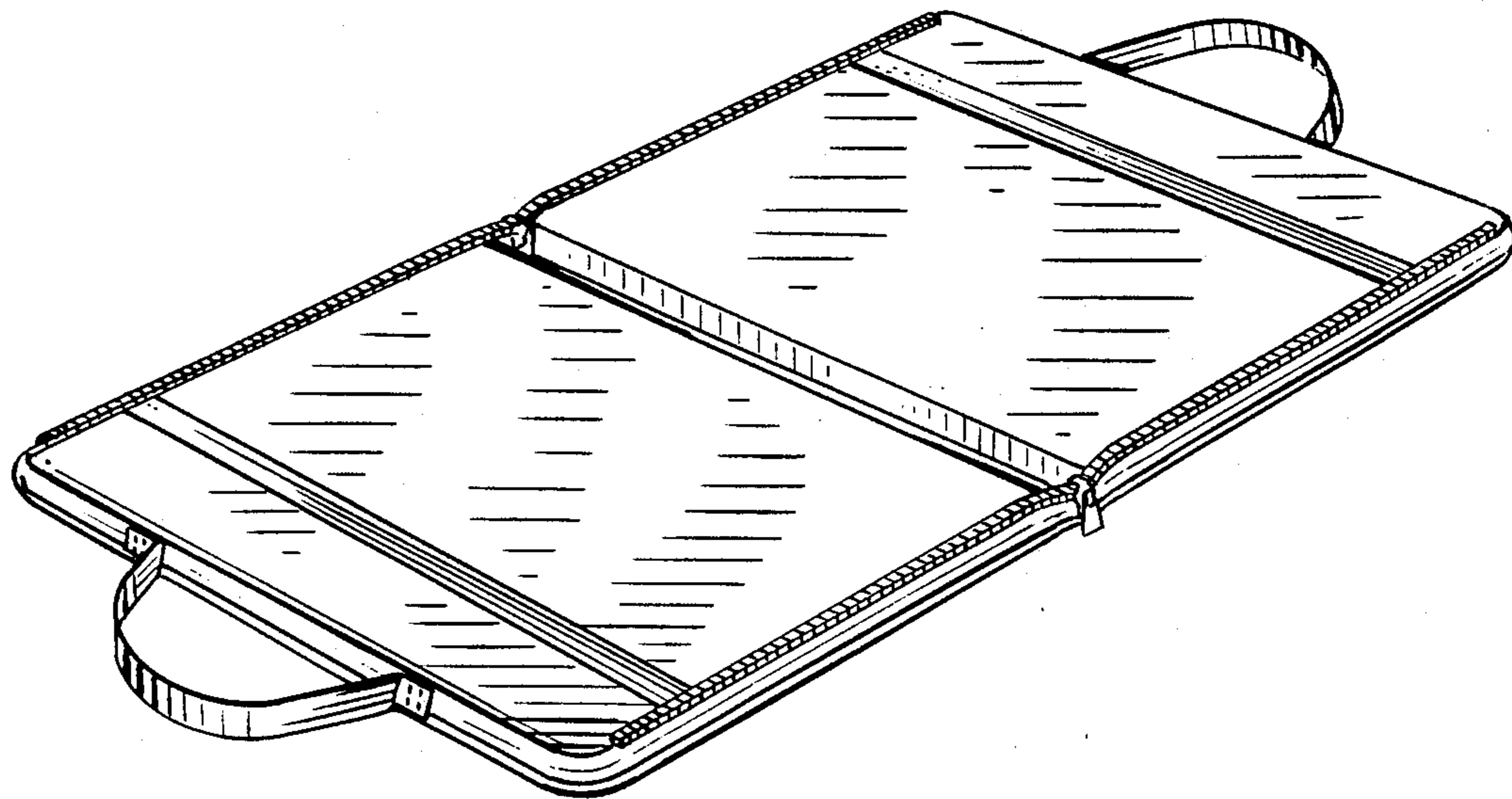

Fig. 5.

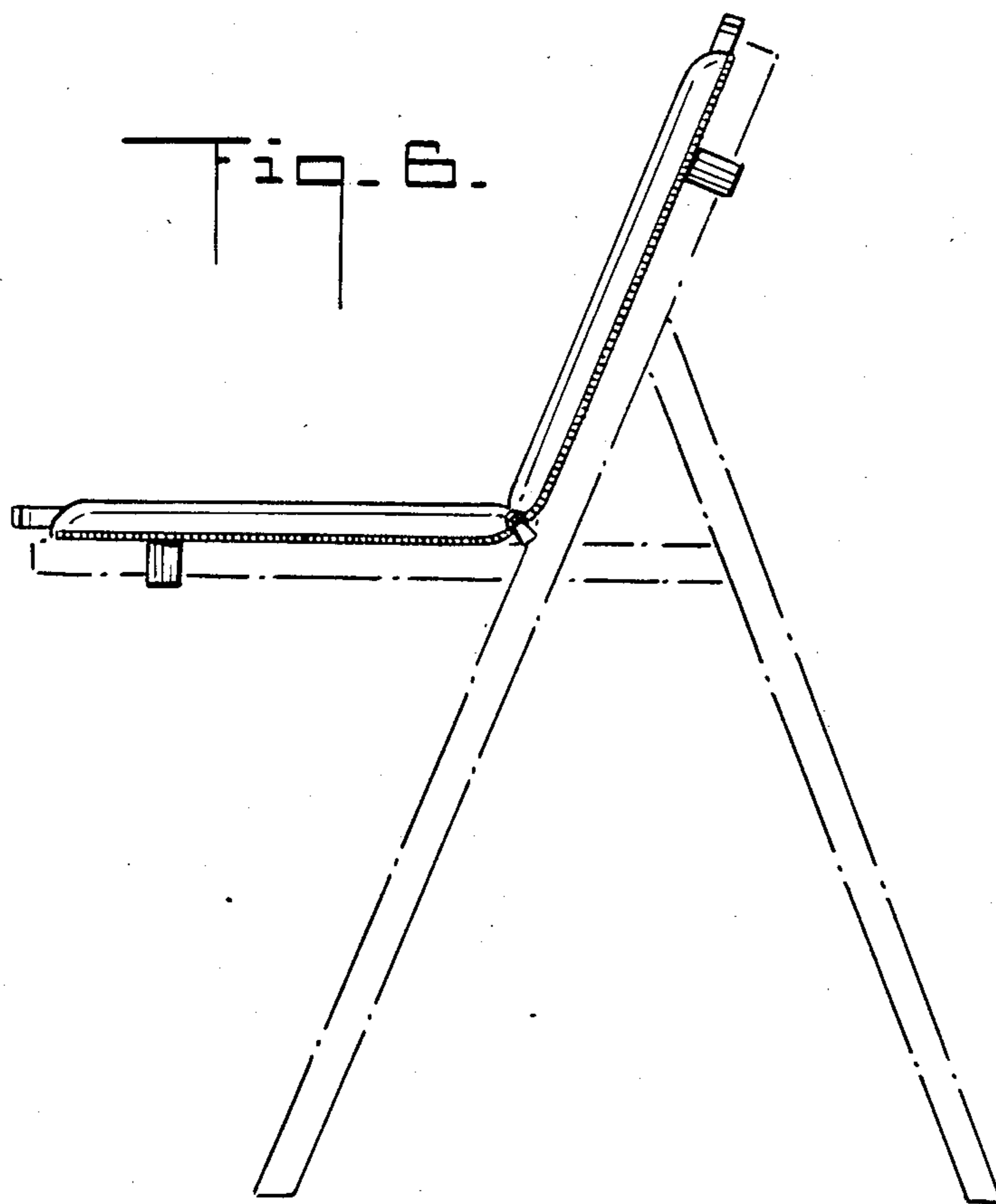

Fig. 6.