

[54] JEWELRY HOLDER

[76] Inventor: Phyllis A. Croy, 2744 SE. Mulberry - Vera Cruz, Bluffton, Ind. 46714

[**] Term: 14 Years

[21] Appl. No.: 51,609

[22] Filed: May 20, 1987

[52] U.S. Cl. D6/553

[58] Field of Search D6/449, 466, 467, 469, D6/553; D3/75; 211/13

[56] References Cited

U.S. PATENT DOCUMENTS

D. 249,603	9/1978	DiBartolo	D6/469
D. 252,899	9/1979	Campbell	D6/469
4,739,886	4/1988	Seaberg	211/13
4,775,053	10/1988	Geiger	211/13

Primary Examiner—Carmen H. Vales-Lado
Attorney, Agent, or Firm—Jeffers, Hoffman & Niewyk

[57] CLAIM

The ornamental design for a jewelry holder, as shown and described.

DESCRIPTION

FIG. 1 is a perspective view of a jewelry holder showing my new design, the broken line showing of a necklace and earrings is for illustrative purposes only and forms no part of the claimed design;

FIG. 2 is a front elevational view thereof;

FIG. 3 is a side elevational view thereof, the opposite side being a mirror image thereof;

FIG. 4 is a bottom plan view thereof;

FIG. 5 is a rear elevational view thereof;

FIG. 6 is a top plan view thereof;

FIG. 7 is a front elevational view of a second embodiment of the earring holder shown in FIG. 1;

FIG. 8 is a rear elevational view thereof;

FIG. 9 is a side elevational view thereof, the opposite side being a mirror image thereof;

FIG. 10 is a top plan view thereof; and

FIG. 11 is a bottom plan view thereof.

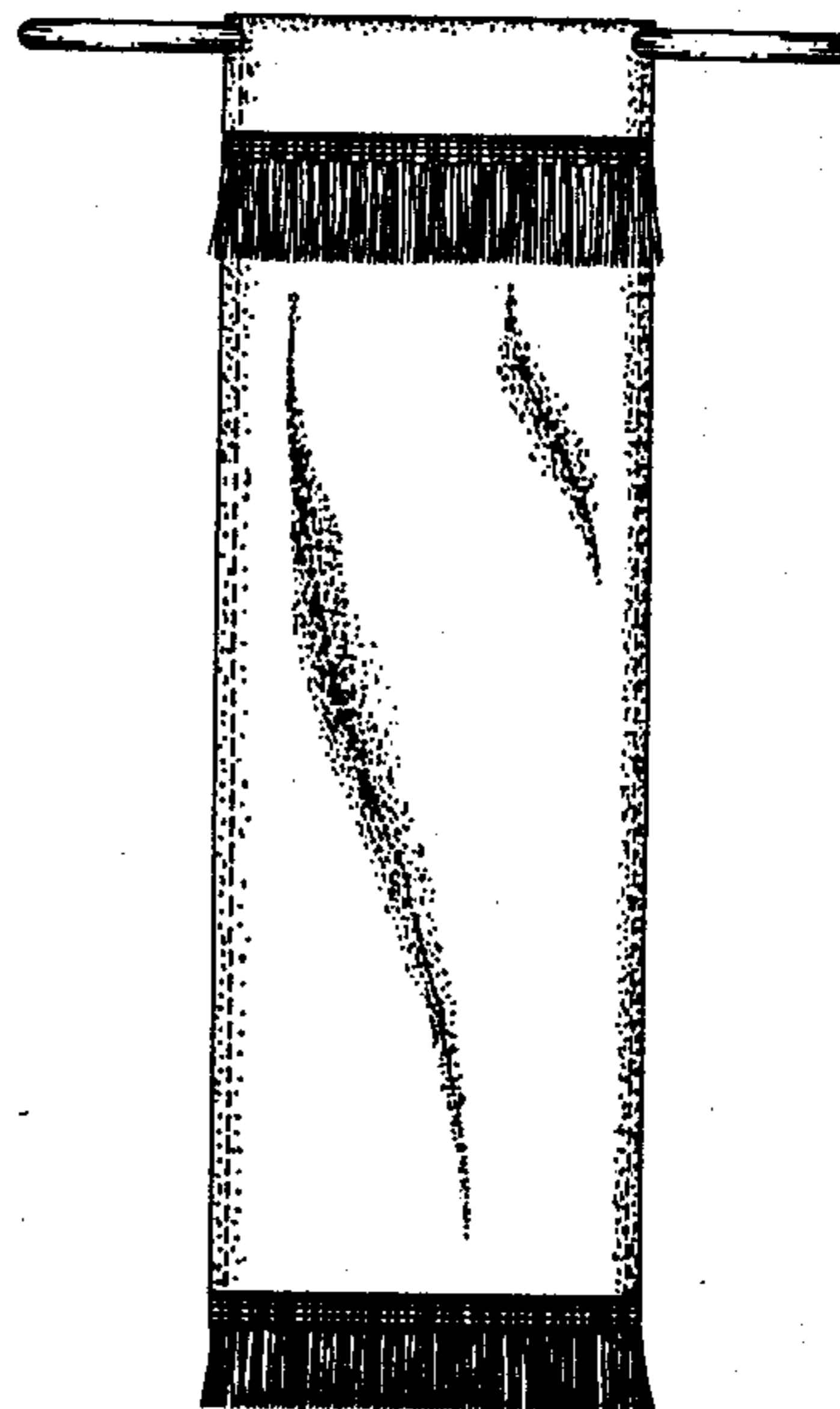
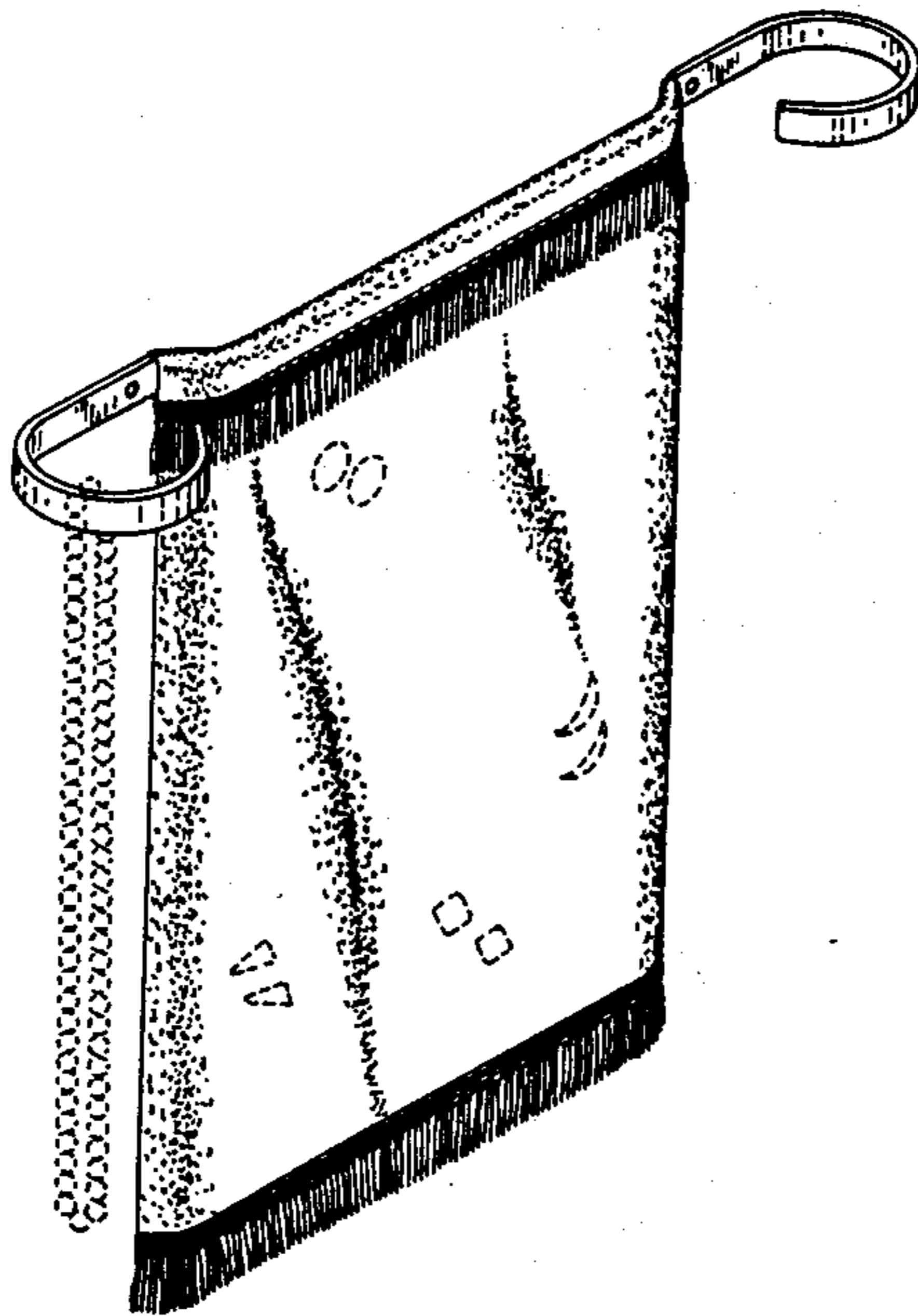

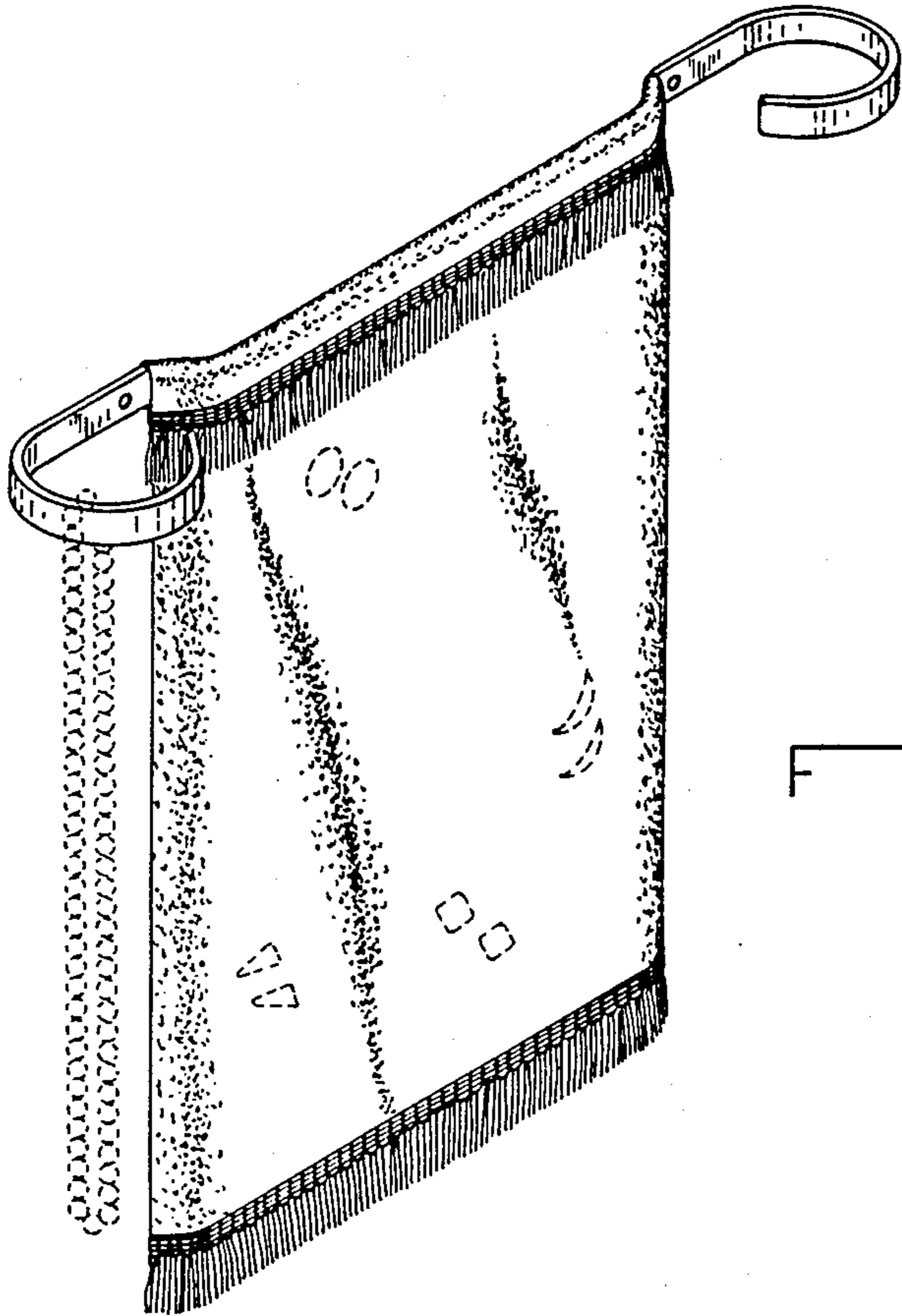

F I G 1

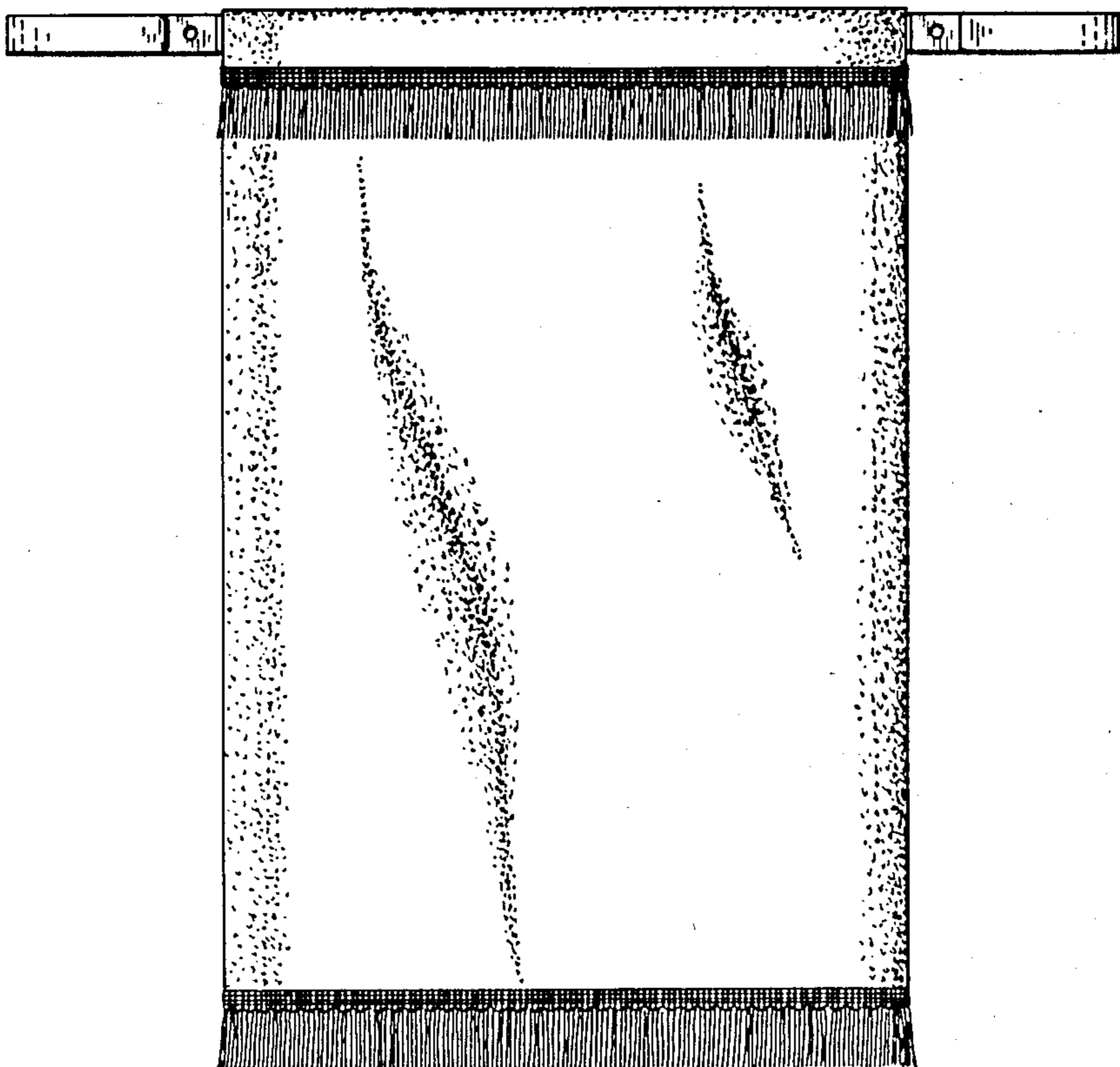

F I G 2

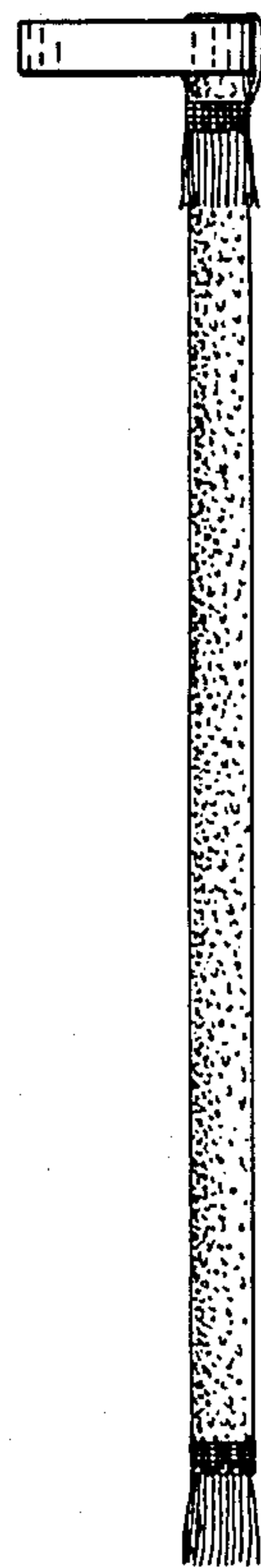

F I G 3

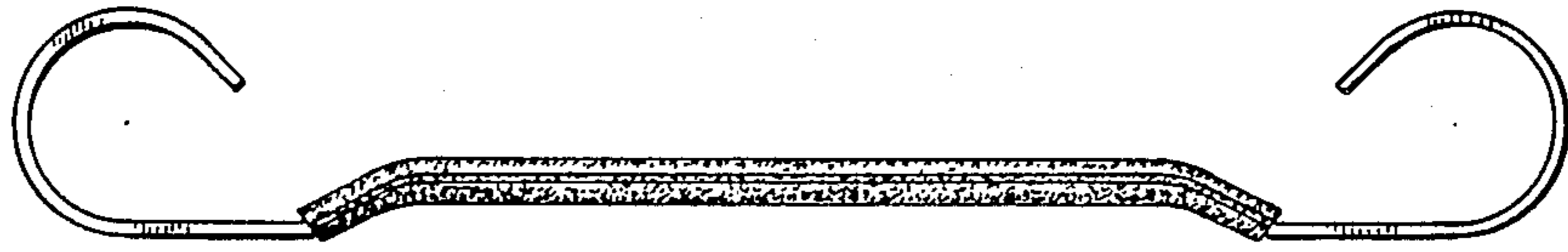

FIG. 4

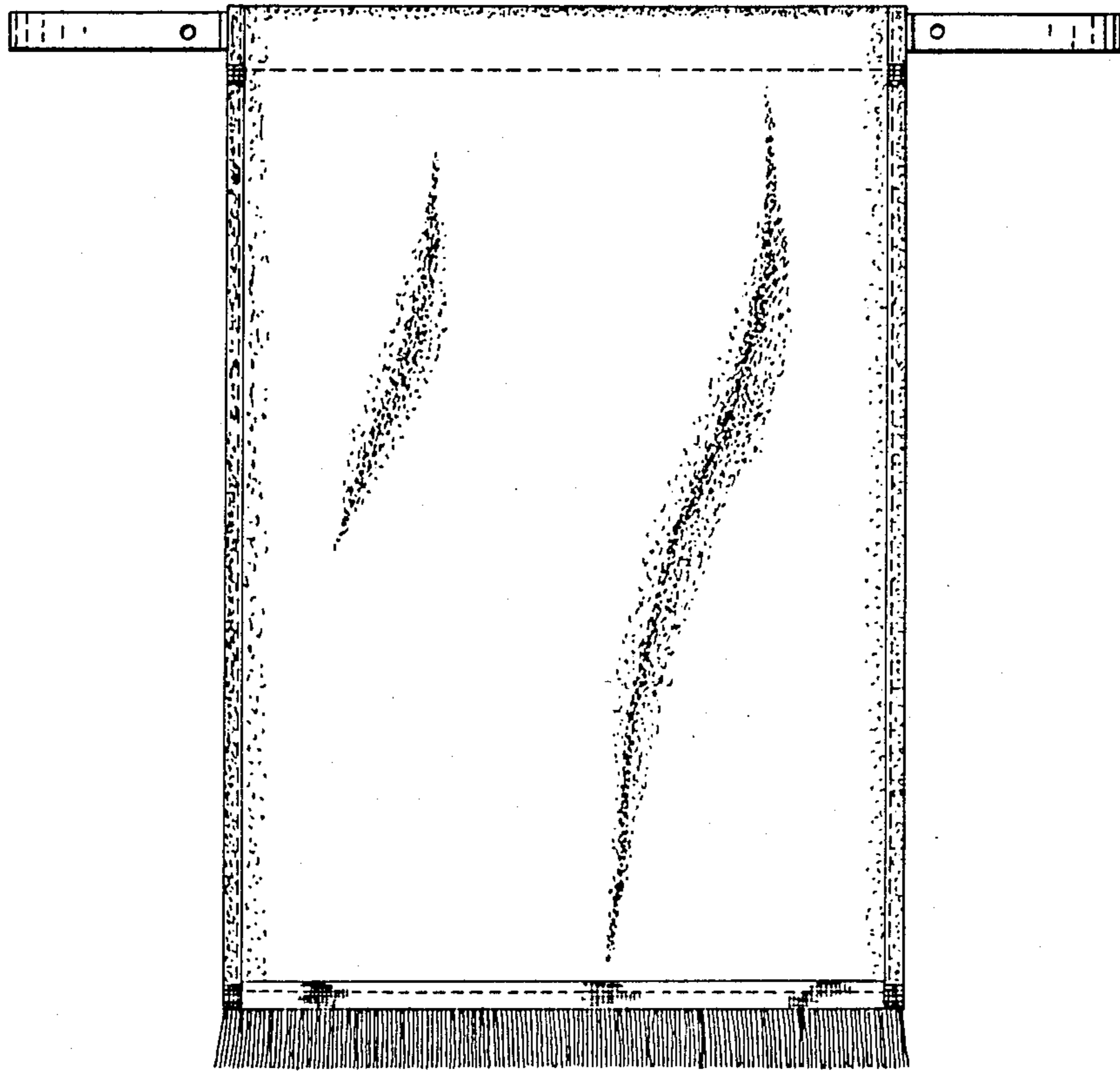

FIG. 5

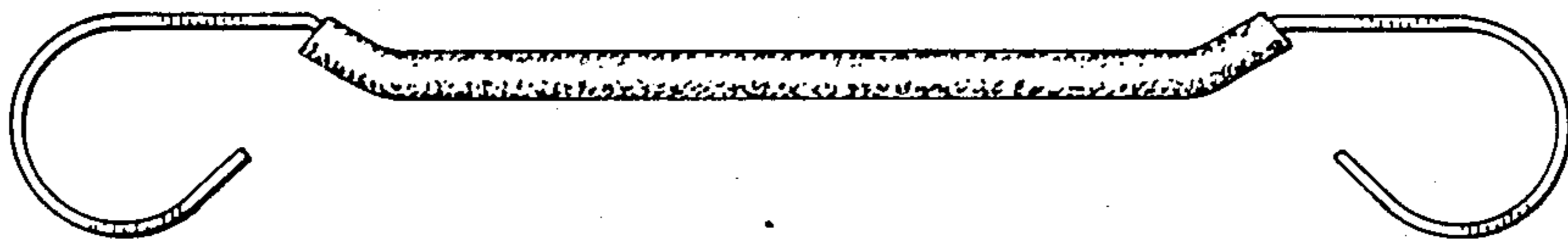

FIG. 6

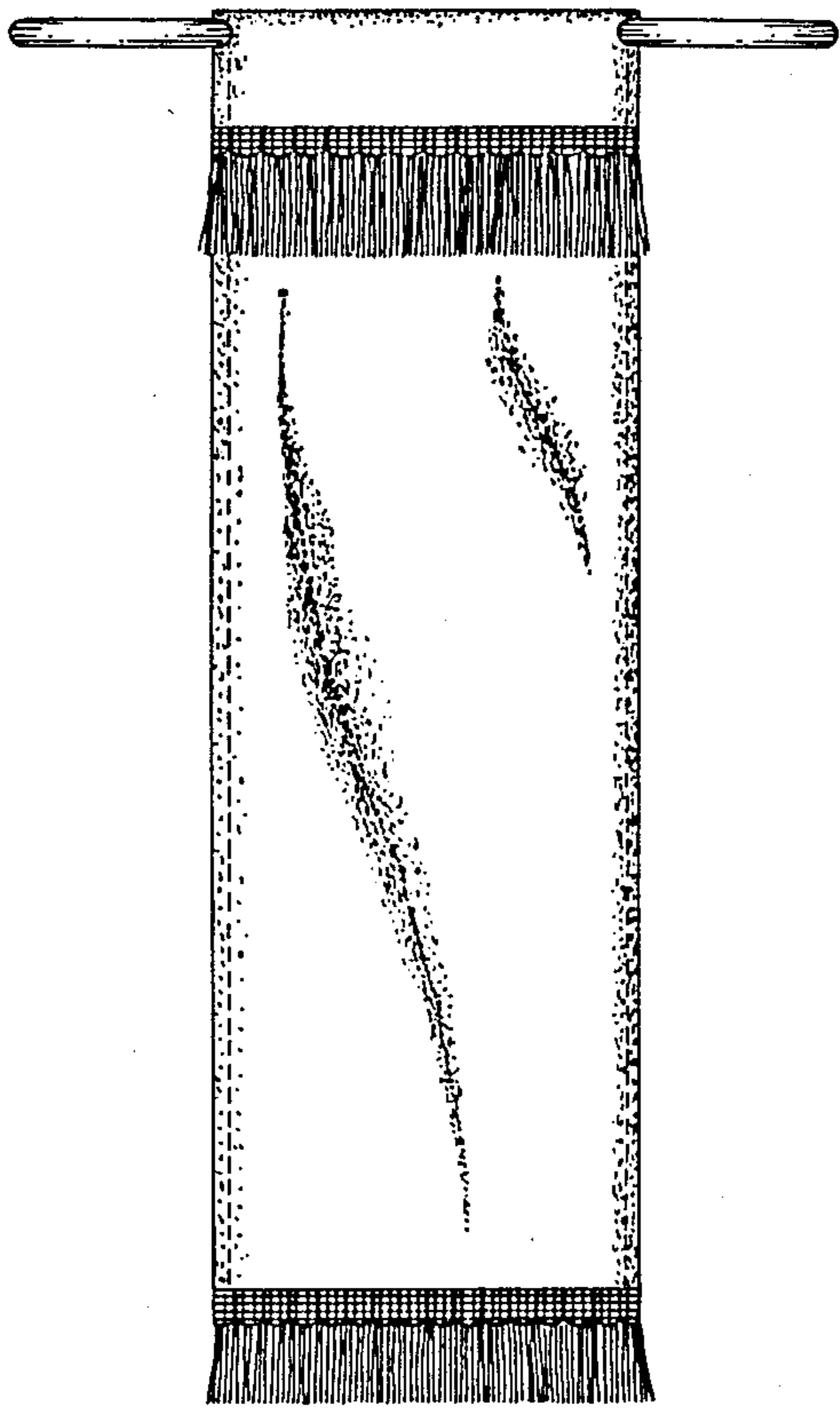

FIG. 7

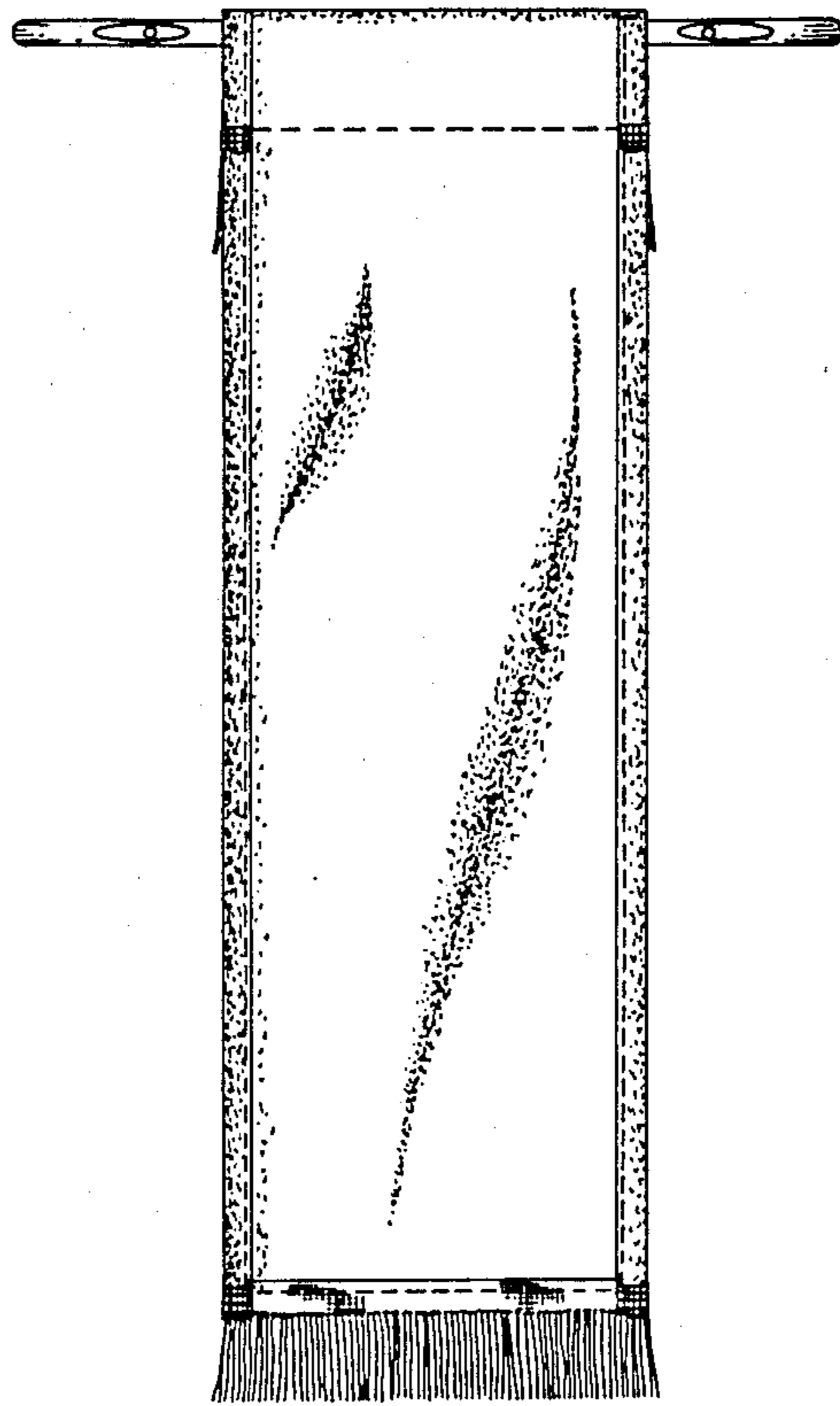

FIG. 8

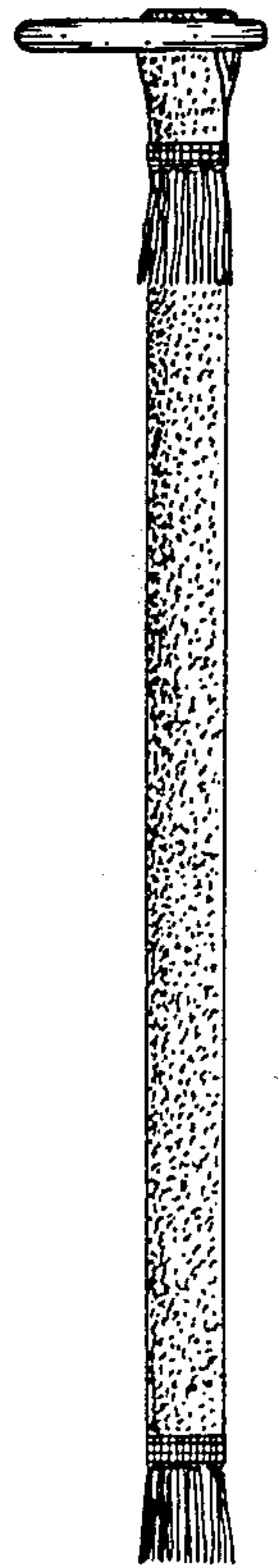

FIG. 9

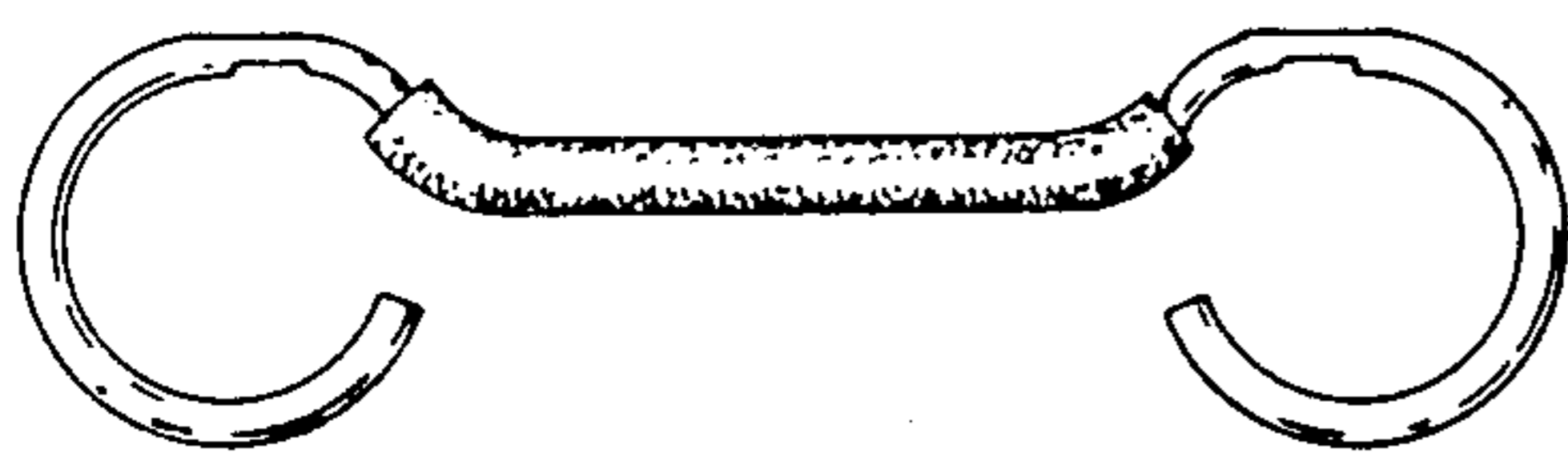

FIG. 10

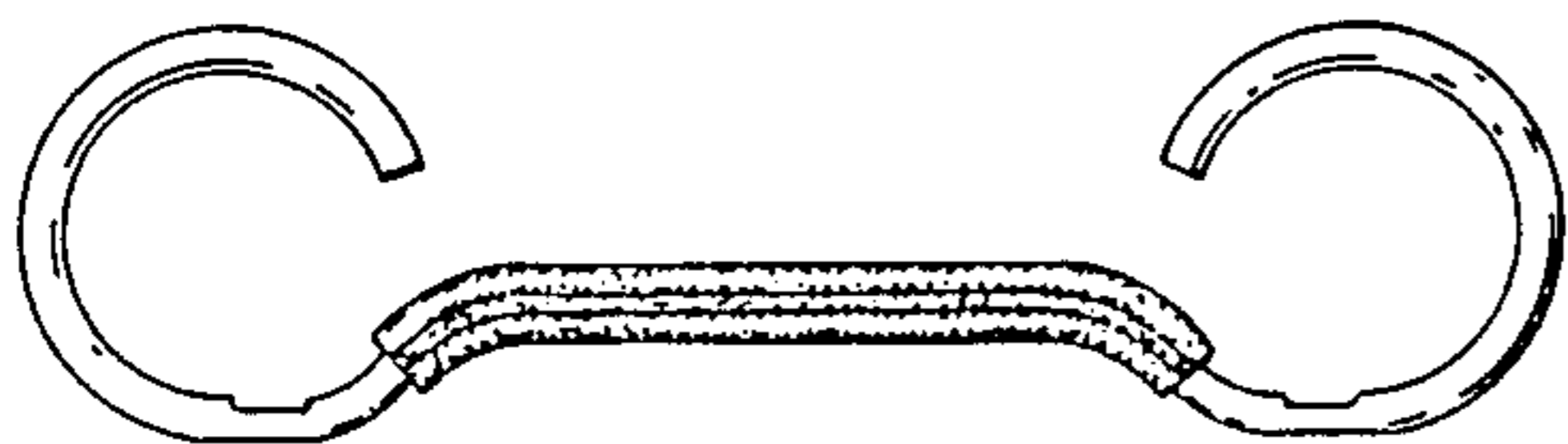

FIG. 11